

# Good. Safe. Yellow.

Catalogue 2019  
Valid from February 2019

**Klingspor**  
Abrasive Technology



# 5

We rank amongst the world's five leading manufacturers of abrasives.

# 1893

Klingspor was founded as a family owned business.

More than

# five hundred

qualified technicians and sales representatives offer professional on-site assistance.

# 300 million

euros in sales during the past year.

Over

# 50 thousand

items in our product range.

Every day Klingspor produces:

## 110,000

abrasive mop discs.

## 350,000

cutting-off wheels and grinding discs.

# One hundred thousand square metres

of coated abrasives.

# 2,900

employees are hard at work everyday to keep our customers satisfied.



**General information**

Contents ..... 3

**Coated abrasives**

Product summary ..... 4-13  
Applications guide ..... 14-17

**Abrasive mop discs**

Applications guide ..... 202-207  
Abrasive mop discs ..... 208-223



**Rolls**

Applications guide ..... 18-19  
Rolls ..... 20-37



**Cutting-off wheels**

Applications guide ..... 224-233  
Cutting-off wheels 0,8-1,0 mm ..... 234-241  
Cutting-off wheels 1,6-1,9 mm ..... 242-245  
Cutting-off wheels 2,0-3,2 mm ..... 246-253  
Large cutting-off wheels ..... 254-263



**Belts**

Applications guide ..... 38-45  
Short and long belts ..... 46-74  
Non-woven belts and spirabands ..... 75-79



**Grinding discs**

Applications guide ..... 224-233, 264-265  
Grinding discs ..... 266-271  
Cup grinding wheels ..... 272-273



**Wide belts**

Applications guide ..... 80-83  
Wide belts ..... 84-97



**Diamond tools**

Applications guide ..... 274-279  
Diamond cutting blades ..... 280-290, 295-308  
Diamond cup grinding wheel ..... 291-294



**Diamond drill bits & other diamond tools**

Diamond drill bits ..... 309-312  
Other diamond tools ..... 313-317

**Fibre discs**

Applications guide ..... 98-101  
Fibre discs ..... 102-111



**Flexible abrasives**

Applications guide ..... 318-320  
Flexible abrasives ..... 321-325



**Strips/sheets/discs**

**Strips/sheets**

Applications guide ..... 112-117  
Strips/sheets ..... 118-139

**Discs**

Applications guide ..... 140-141  
Discs ..... 142-161



**Carbide burrs**

Applications guide ..... 326-329  
Carbide burrs ..... 330-341



**Quick Change Discs**

Applications guide ..... 162-165  
Quick Change Discs ..... 166-175



**D.I.Y. range**

Applications guide ..... 342-343  
D.I.Y. range ..... 344-353



**Abrasive mops**

Applications guide ..... 176-181  
Abrasive mop wheels, nylon webbed mop, abrasive flap drums ..... 182-191

**Small abrasive mops**

Applications guide ..... 192-193  
Small abrasive and finishing mops ..... 194-201



**Service**

Point of Sale ..... 354-355  
Safety recommendations ..... 356-357  
oSa ..... 362



All articles included in this catalogue with catalogue numbers are items that are held in stock in Germany and can be delivered within a short time.

# The product groups at a glance

With this catalogue, Klingspor makes it quick and easy to select the products you need from our huge range of top quality abrasives. The clear and logical layout in eleven product groups makes it easy for you to find what you are looking for.

State-of-the-art manufacturing techniques ensure that our coated abrasives fulfill the most demanding standards of surface finish, long life and stock removal.



### Belts

Klingspor abrasive belts are available in various sizes and grades to meet all sanding and grinding requirements for a wide range of materials and applications.



### Fibre discs

Klingspor fibre discs are exceptionally suited for rough grinding work, derusting metal parts, deburring and working on welded seams.



### Rolls

Klingspor rolls for hand sanding or use with handheld machines are available in a number of special grades designed for a wide variety of materials – from wood, to metal, to paint.



### Abrasive strips, sheets and discs

Klingspor strips, sheets and discs are available in various qualities and designs.



### Abrasive mop wheels

The abrasive mop wheel is particularly suitable for finishing where flexibility is a must. It matches the contours of any workpiece perfectly. Klingspor has the right abrasive mop wheel for virtually every application and for nearly all types of material.

# General information

Product overview



## Abrasive mop discs

The performance of the Klingspor abrasive mop disc, with its fan-shaped radial arrangement of the cloth grinding flaps, far exceeds that of other abrasive products.



## Kronenflex grinding discs and cutting-off wheels

Continuous innovation and the development of specialised products for all application areas enables Klingspor to offer a range of grinding discs and cutting-off wheels to satisfy every need.



## D.I.Y. range

The complete range available with relevant grit ranges and assortments in customised packing units. Uniform packing design with precise product identification for quick access.



## Flexible abrasives

Flexible abrasives which were developed by Klingspor for precision finishing and polishing work on all kinds of surfaces.



## Carbide burrs

Klingspor carbide burrs are manufactured according to the highest quality standards and with utmost precision. The different cuts are adapted to meet the specific requirements of various materials and applications.



## Diamond tools

Klingspor's comprehensive range of diamond tools makes it easy for any user to work faster and with greater precision and endurance. As they are made of carefully tested premium grade materials, the products included in each product line offer a wide range of possible applications and meet the highest safety standards.



# General information

Product overview



Hand sanding



Hand block

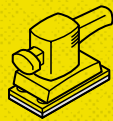

Orbital sander



Random orbital sander



Delta sander



Portable belt sander

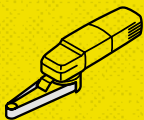

Hand tool belt grinder

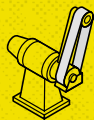

Back stand grinding machine

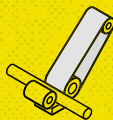

Centreless finishing machine



Through-feed grinding machine

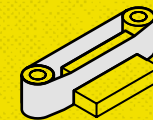

Edge sanding machine

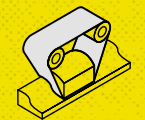

Contour finishing machine

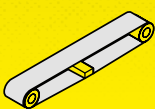

Pad / stroke sanding machine



Wide belt finishing machine

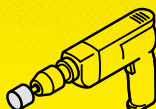

Drilling machine

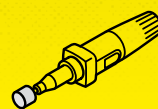

Die grinder



Satin finishing machine

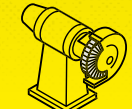

Floor standing grinder

# General information

Product overview



General information

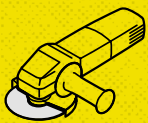

Angle grinder

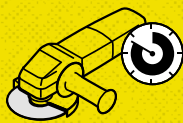

Variable speed angle grinder

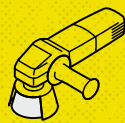

Angle grinder with cup grinding wheel

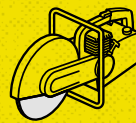

Petrol powered cutter

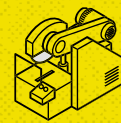

Stationary cutting machine  $\leq 5\text{kW}$



Chop saw



Drilling machine



Joint cutter



Lifting beam with mottling points

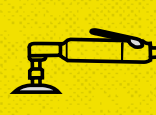

Right angle die grinder



Flexible shaft grinder

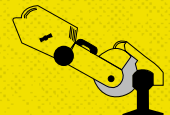

Petrol powered cutter with clamping device



Fillet weld grinder



Table saw

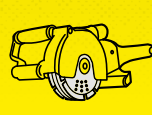

Joint router



Stationary cutting machine  $> 5\text{kW}$



Parquet sander

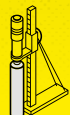

Drill stand



# Product guide

Coated abrasives

	Type	Properties	Backing	Grain type
Abrasive paper	<i>PS 8 A</i>	Waterproof	A-paper	SiC
	<i>PS 8 C</i>	Waterproof	C-paper	SiC
	<i>PS 11 A</i>	Waterproof	A-paper	SiC
	<i>PS 11 C</i>	Waterproof	C-paper	SiC
	<i>PS 20 F</i>		F-paper	Aluminium oxide
	<i>PS 21 F</i>		F-paper	Zirconia alumina
	<i>PS 22 F ACT</i>	ANTISTATIC	F-paper	Aluminium oxide
	<i>PS 22 N</i>		E-paper	Aluminium oxide
	<i>PS 24 F ACT</i>	ANTISTATIC	F-paper	SiC
	<i>PS 27 DW</i>	Specially coated, ANTISTATIC	D-paper	SiC
	<i>PS 28 F</i>	ANTISTATIC	F-paper	Aluminium oxide
	<i>PS 29 F ACT</i>	ANTISTATIC	F-paper	Aluminium oxide
	<i>PS 30 D</i>		D-paper	Aluminium oxide
	<i>PL 31 B</i>		B-paper	Aluminium oxide
	<i>PS 33 B</i>		B-paper	Aluminium oxide
	<i>PS 33 C</i>		C-paper	Aluminium oxide
	<i>PS 38 G ACT</i>	ANTISTATIC	G-paper	SiC
	<i>PS 61 F</i>		F-paper	Ceramic aluminium oxide
	<i>PS 729 F</i>		F-paper	Aluminium oxide-agglomerate
	<i>FP 73 W</i>	Specially coated	Film	Aluminium oxide
	<i>PS 73 BW</i>	Specially coated	B-paper	Aluminium oxide
	<i>PS 73 BWF</i>	Specially coated	B-paper + foam core	Aluminium oxide
	<i>PS 73 CWF</i>	Specially coated	C-paper + foam core	Aluminium oxide
Self-fastening	<i>PS 19 EK</i>		E-paper	SiC
	<i>PS 21 FK</i>		F-paper	Zirconia alumina
	<i>PS 22 K</i>		E-paper	Aluminium oxide
	<i>PS 33 BK</i>		B-paper	Aluminium oxide
	<i>PS 33 CK</i>		C-paper	Aluminium oxide
	<i>CS 411 XK</i>		X-cotton	Zirconia alumina
	<i>PS 61 FK</i>		F-paper	Ceramic aluminium oxide
	<i>FP 73 WK</i>	Specially coated	Film	Aluminium oxide
	<i>PS 73 BWK</i>	Specially coated	B-paper	Aluminium oxide
	<i>PS 73 CWK</i>	Specially coated	C-paper	Aluminium oxide

## Cloth

X	Cloth, heavy
J	Cloth, light
XF	Cloth, heavy, flexible
JF	Cloth, light, highly flexible
Y	Polyester cloth
Z	Polyester cloth, heavy, can be divided into segments

## Paper

A	approx. 95 g/m <sup>2</sup>
B	approx. 105 g/m <sup>2</sup>
C	approx. 110 g/m <sup>2</sup>
D	approx. 130 g/m <sup>2</sup>
E	approx. 250 g/m <sup>2</sup>
F	approx. 300 g/m <sup>2</sup>
G	approx. 400 g/m <sup>2</sup>



# Product guide

Coated abrasives



				Page										
Type	Coating	Bonding agent	Waterproof	Available grits	Rolls	File belts	Belts for handheld grinders	Short and long belts	Spirabands	Wide belts	Fibre discs	Strips	Sheets	Discs
<i>PS 8 A</i>	●	K	✓	180-2500										118
<i>PS 8 C</i>	●	K	✓	60-150										118
<i>PS 11 A</i>	●	K	✓	220-2000										120
<i>PS 11 C</i>	●	K	✓	60-400, 600, 1000										119 142
<i>PS 20 F</i>	●	K		60-240, 320, 400				53		84				
<i>PS 21 F</i>	●	K		40, 60-320, 400				53		84				
<i>PS 22 F ACT</i>	●	K		40, 60-400	20			53		85		124		
<i>PS 22 N</i>	○	K		24, 40, 60-240, 320, 400	21									
<i>PS 24 F ACT</i>	●	K		80, 120-800				54		85				
<i>PS 27 DW</i>	○	K		180-320, 400-600				54		86				
<i>PS 28 F</i>	○	K		40-220				54		86				
<i>PS 29 F ACT</i>	○	K		40-320, 400	25			55		87				
<i>PS 30 D</i>	○	K		40, 60-240, 320	21							124	121	
<i>PL 31 B</i>	○	L		40-320, 400	22							125	121	
<i>PS 33 B</i>	○	K		150-320, 400-600	24									123
<i>PS 33 C</i>	○	K		40, 60-120	23									122
<i>PS 38 G ACT</i>	●	K		80-180						88				
<i>PS 61 F</i>	●	K		40, 60, 80, 120-320, 400				56		88				
<i>PS 729 F</i>		K		180, 240, 320				56		89				
<i>FP 73 W</i>	○	K		80-180, 240, 320, 400, 600-1500				57						
<i>PS 73 BW</i>	○	K		150-1500									123	
<i>PS 73 BWF</i>	○	K		180, 240, 320, 400, 600	26									
<i>PS 73 CWF</i>	○	K		120	25									
<i>PS 19 EK</i>	●	K		36, 40, 60-220, 320, 400, 600								126		143
<i>PS 21 FK</i>	●	K		40, 60-180, 240, 320, 400										143
<i>PS 22 K</i>	○	K		24, 40, 60-240, 320, 400								126		144
<i>PS 33 BK</i>	○	K		150-320, 400-600								128		150
<i>PS 33 CK</i>	○	K		40, 60-120								127		148
<i>CS 411 XK</i>	●	K		24, 40, 60, 80, 120										158
<i>PS 61 FK</i>	●	K		40, 60, 80, 120-180, 240, 280										151
<i>FP 73 WK</i>	○	K		80-180, 240, 320, 400, 600-1500								129		152
<i>PS 73 BWK</i>	○	K		150-1500										154
<i>PS 73 CWK</i>	○	K		40, 60-120										153

● = close ○ = semi-open ○ = open

### Bonding agent

K Resin  
L Glue

# Product guide

Coated abrasives

Type	Properties	Backing	Grain type
<b>CS 308 Y</b>		Y-polyester	Aluminium oxide
<b>LS 309 J</b>		J-cotton	Aluminium oxide
<b>LS 309 JF</b>		JF-cotton	Aluminium oxide
<b>LS 309 X</b>		X-cotton	Aluminium oxide
<b>LS 309 XH</b>		X-cotton	Aluminium oxide
<b>CS 310 X</b>		X-cotton	Aluminium oxide
<b>CS 310 XF</b>		XF-cotton	Aluminium oxide
<b>CS 311 Y ACT</b>	ANTISTATIC	Y-polyester	Aluminium oxide
<b>LS 312 JF</b>		JF-cotton	Aluminium oxide
<b>LS 313 JF</b>	Multibond	JF-cotton	Aluminium oxide
<b>LS 314 JF</b>		JF-cotton	Aluminium oxide
<b>LS 318 JF ACT</b>	ANTISTATIC	JF-cotton, SUPERFLEX	Aluminium oxide
<b>CS 320 Y</b>	Waterproof	Y-polyester	SiC
<b>CS 321 X</b>	Waterproof	X-cotton	SiC
<b>CS 322 X</b>	Waterproof	X-cotton	Cork
<b>CS 325 Y</b>	KULEX, waterproof	Y-polyester	SiC agglomerate
<b>CS 326 Y</b>	KULEX, waterproof	Y-polyester	Aluminium oxide-agglomerate
<b>CS 329 JF</b>	KULEX	JF-cotton	Aluminium oxide-agglomerate
<b>CS 329 Y</b>	KULEX	Y-polyester	Aluminium oxide-agglomerate
<b>CS 330 X</b>	Waterproof	X-cotton	SiC / cork
<b>CS 333 JF</b>		JF-cloth	SiC
<b>CS 333 X</b>		X-cotton	SiC
<b>CS 333 XF</b>		XF-cotton	SiC
<b>CS 336 Y</b>	ANTISTATIC	Y-polyester	SiC
<b>CS 341 X</b>	Waterproof	X-cotton	Aluminium oxide
<b>KL 361 JF</b>		JF-cotton	Aluminium oxide
<b>KL 371 X</b>		X-cotton	Aluminium oxide
<b>KL 385 JF</b>		JF-cotton	Aluminium oxide
<b>CS 409 Y</b>	Multibond	Y-polyester	Zirconia alumina
<b>CS 410 X</b>	Multibond	X-cotton	Aluminium oxide
<b>CS 411 X</b>		X-cotton	Zirconia alumina
<b>CS 411 Y</b>	Waterproof	Y-polyester	Zirconia alumina
<b>CS 412 Y</b>	Waterproof	Y-polyester	Aluminium oxide
<b>CS 416 Y</b>	Waterproof	Y-polyester	Zirconia alumina
<b>CS 420 Y</b>	Waterproof, NOPPEX	Y-polyester	Aluminium oxide
<b>CS 451 X</b>	Multibond	X-cotton	Zirconia alumina
<b>GX 533 JF</b>		JF-blended cloth	SiC
<b>CS 538 Z ACT</b>	ANTISTATIC	Z-polyester	SiC
<b>CS 631 XF</b>	Multibond	XF-cotton	Ceramic aluminium oxide
<b>CS 710 XF</b>		XF-cotton	Aluminium oxide
<b>GX 712 JF</b>		JF-blended cloth	Aluminium oxide
<b>CS 811 Y ACT</b>	Waterproof	Y-polyester	Zirconia alumina
<b>CS 910 Y ACT</b>	Multibond	Y-polyester	Ceramic aluminium oxide
<b>CS 912 Y ACT</b>	Waterproof	Y-polyester	Ceramic aluminium oxide
<b>CS 931 JF</b>	Multibond	JF-cotton	Ceramic aluminium oxide
<b>GX 931 JF</b>	Multibond	JF-blended cloth	Ceramic aluminium oxide

Abrasive cloth

## Cloth

X	Cloth, heavy
J	Cloth, light
XF	Cloth, heavy, flexible
JF	Cloth, light, highly flexible
Y	Polyester cloth
Z	Polyester cloth, heavy, can be divided into segments

## Paper

A	approx. 95 g/m <sup>2</sup>
B	approx. 105 g/m <sup>2</sup>
C	approx. 110 g/m <sup>2</sup>
D	approx. 130 g/m <sup>2</sup>
E	approx. 250 g/m <sup>2</sup>
F	approx. 300 g/m <sup>2</sup>
G	approx. 400 g/m <sup>2</sup>

# Product guide

Coated abrasives



				Page										
Type	Coating	Bonding agent	Waterproof	Available grits	Rolls	File belts	Belts for handheld grinders	Short and long belts	Spirabands	Wide belts	Fibre discs	Strips	Sheets	Discs
CS 308 Y	●	K		40, 60-180, 240				58		90				
LS 309 J	●	K		60-500				59						
LS 309 JF	●	K		60-400, 600, 800	27			60						
LS 309 X	●	K		40-360	27	46		58						
LS 309 XH	●	K		40-180, 240			51							
CS 310 X	●	K		16-24, 36-320, 400-600				60	76	90				
CS 310 XF	●	K		40-280		46								
CS 311 Y ACT	○	K		36-220				61		91				
LS 312 JF	●	K		60-320, 400				62						
LS 313 JF	●	K		80-240, 320, 400				62						
LS 314 JF	●	K		100, 120, 180, 320				63						
LS 318 JF ACT	○	K		80-180, 240, 320, 400				63						
CS 320 Y	●	K	✓	24, 40, 60-120, 180				63		91				
CS 321 X	●	K	✓	80-320, 400, 500, 800				64		92				
CS 322 X	●	K	✓	Polishing fineness				64						
CS 325 Y		K	✓	80, 120, 180, 240, 320, 400, 600, 800, 1200				64						
CS 326 Y		K	✓	60, 80, 120, 180, 240, 320, 400, 600, 800				65		92				
CS 329 JF		K		120, 180, 240				65						
CS 329 Y		K		80, 120, 180, 240, 320, 400, 600				65		93				
CS 330 X	●	K	✓	220, 400, 600, 800				66		93				
CS 333 JF	●	K		120-180, 240-320				67						
CS 333 X	●	K		24, 36, 40, 60-150, 240				66						
CS 333 XF	●	K		60-100, 240, 280				66						
CS 336 Y	○	K		36, 40, 50						94				
CS 341 X	●	K	✓	60-320, 400, 500, 600				67		94				
KL 361 JF	●	K		30, 40-600	28							134	131	
KL 371 X	●	L		30-320, 400									132	
KL 385 JF	●	K		40-320, 400, 600	31								133	
CS 409 Y	●	K		36-120				67		95				
CS 410 X	●	K		40, 60-180				68						
CS 411 X	●	K		24, 36-80, 120				68						
CS 411 Y	●	K	✓	24, 36-120		47		69		95				
CS 412 Y	●	K	✓	24, 36-180, 240				70		96				
CS 416 Y	○	K	✓	24, 36-120				70						
CS 420 Y		K	✓	120, 180, 240, 320, 400				71						
CS 451 X	●	K		40, 60, 80					77					
GX 533 JF	●	K		80-180, 240-400, 600				71						
CS 538 Z ACT	●	K		36-180						96				
CS 631 XF	○	K		60-120				71						
CS 710 XF	●	K		80-180, 240		48		72						
GX 712 JF	●	K		60-320, 400				72						
CS 811 Y ACT	●	K	✓	24, 36-80				73						
CS 910 Y ACT	●	K		24, 36-80				73						
CS 912 Y ACT	●	K	✓	36-180		49		73		97				
CS 931 JF	○	K		80-120, 180, 240-320, 400				74						
GX 931 JF	○	K		60-150, 280				74						

● = close ○ = semi-open ○ = open

### Bonding agent

K Resin  
L Glue



# Product guide

Coated abrasives

	Type	Properties	Backing	Grain type
Fibre discs	<b>CS 561</b>		Fibre	Aluminium oxide
	<b>FS 764 ACT</b>		Fibre	Aluminium oxide
	<b>CS 565</b>		Fibre	Zirconia alumina
	<b>CS 570</b>	Multibond	Fibre	Zirconia alumina
	<b>FS 964 ACT</b>		Fibre	Ceramic aluminium oxide
	<b>FS 966 ACT</b>	Multibond	Fibre	Ceramic aluminium oxide
Non-woven web	<b>AN 400</b>	Waterproof	Abrasive screen	Aluminium oxide
	<b>NRO 400</b>		Non-woven web	Aluminium oxide
	<b>NRO 500</b>		Non-woven web	SiC
	<b>NPA 400</b>		Non-woven web	Aluminium oxide
	<b>NPA 500</b>		Non-woven web	SiC
	<b>SV 484</b>		Non-woven web with polyester lining	Aluminium oxide
	<b>NDS 400 K</b>	Waterproof	Non-woven web with polyester lining	Aluminium oxide / SiC
	<b>NDS 800</b>		Non-woven web with polyester lining	Aluminium oxide
	<b>NBF 800</b>	Waterproof	Non-woven web with polyester lining	Aluminium oxide
	<b>NBS 800</b>	Waterproof	Non-woven web with polyester lining	Aluminium oxide
	<b>FD 500</b>	Waterproof	Foam core	Aluminium oxide / SiC
	<b>SK 500</b>	Abrasive hand block, flexible, waterproof	Sponge	Aluminium oxide
	<b>SK 700 A</b>	Abrasive hand block, waterproof	Sponge	Aluminium oxide
	<b>SW 501</b>	Abrasive sponge, waterproof	Sponge	Aluminium oxide
<b>SW 502</b>	Abrasive sponge, waterproof	Sponge	SiC	
<b>SW 510</b>	Abrasive sponge, waterproof	Sponge	Aluminium oxide	
<b>SW 512</b>	Abrasive sponge, waterproof	Sponge	SiC	

## Cloth

X	Cloth, heavy
J	Cloth, light
XF	Cloth, heavy, flexible
JF	Cloth, light, highly flexible
Y	Polyester cloth
Z	Polyester cloth, heavy, can be divided into segments

## Paper

A	approx. 95 g/m <sup>2</sup>
B	approx. 105 g/m <sup>2</sup>
C	approx. 110 g/m <sup>2</sup>
D	approx. 130 g/m <sup>2</sup>
E	approx. 250 g/m <sup>2</sup>
F	approx. 300 g/m <sup>2</sup>
G	approx. 400 g/m <sup>2</sup>

# Product guide

Coated abrasives



				Page											
Type	Coating	Bonding agent	Waterproof	Available grits	Rolls	File belts	Belts for handheld grinders	Short and long belts	Spirabands	Wide belts	Fibre discs	Strips	Sheets	Discs	
Fibre discs	CS 561	●	K		16-240, 320						102				
	FS 764 ACT	●	K		24, 36, 40-80, 120						104				
	CS 565	●	K		24, 36-100						105				
	CS 570	●	K		24, 36-120						106				
	FS 964 ACT	●	K		24, 36-80, 120						107				
	FS 966 ACT	●	K		24, 36-60, 80, 120						108				
AN 400	○	K	✓	80-800								130		155	
Non-woven web	NRO 400		K		medium, fine, very fine	35									
	NRO 500		K		medium, ultra fine	36									
	NPA 400		K		coarse, medium, very fine							135			
	NPA 500		K		medium, ultra fine, without grain							135			
	SV 484		K		coarse, medium, very fine									160	
	NDS 400 K		K	✓	very fine, ultra fine									160	
	NDS 800		K		coarse, medium, very fine									161	
	NBF 800		K	✓	coarse, medium, very fine	49									
	NBS 800		K	✓	coarse, medium, very fine			75							
	FD 500	●	K	✓	1000, 1500, 2000, 3000										156
	SK 500	●	K	✓	60, 80, 100, 120, 180, 220, 280							137			
	SK 700 A	●	K	✓	60, 80, 100, 120							137			
	SW 501	●	K	✓	120, 220							138			
SW 502	●	K	✓	120, 220							139				
SW 510	●	K	✓	100, 180, 220, 320							138				
SW 512	●	K	✓	120, 180, 220, 320							139				

● = close   ● = semi-open   ○ = open

## Bonding agent

K Resin  
L Glue

# Coated abrasives

## Applications guide

Coated abrasives are abrasive products that are made out of more or less flexible backing material upon which grit is anchored with a bonding agent. The product family “coated abrasives” includes abrasive belts, rolls, sheets, strips and discs. They comprise of the following four, optionally also five, components (please refer to the illustration on the right).

- ▶ 1. Backing
- ▶ 2. Base coat
- ▶ 3. Grit
- ▶ 4. Topsize coat
- ▶ 5. Optional: additional coating

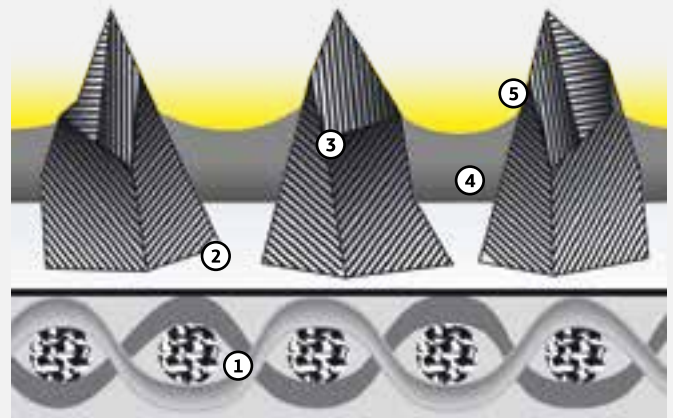

## Structure

### 1. Coated abrasive backing

The backing is coated with grit and transfers stock removal forces onto the workpiece. The following backings are primarily used in the manufacture of coated abrasives:

- ▶ Paper
- ▶ Cotton cloth
- ▶ Polyester cloth

In addition, at Klingspor the following backings are used exclusively for individual products and/or for specific requirements/applications:

- ▶ Fibre (is used exclusively for fibre discs on portable angle grinders)
- ▶ Film (is used exclusively for the products FP 73 W and FP 73 WK)
- ▶ GX-blended cloth (special cotton/polyester blend for flexible yet highly tear resistant belts)

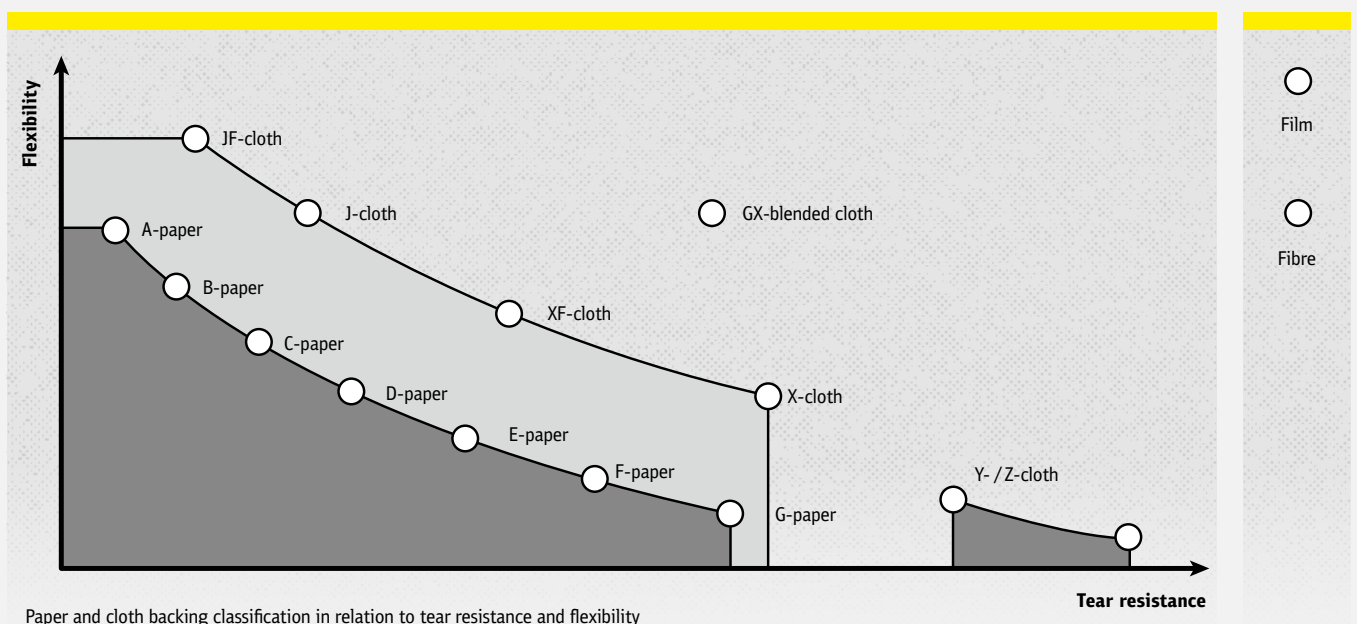



# Coated abrasives

Applications guide



Backing	Description	Application examples
A – paper	approx. 95 g/m <sup>2</sup>	profile + surface grinding (hand)
B – paper	approx. 105 g/m <sup>2</sup>	profile + surface grinding (hand)
C – paper	approx. 110 g/m <sup>2</sup>	surface grinding (hand)
D – paper	approx. 130 g/m <sup>2</sup>	surface grinding (hand and machine)
E – paper	approx. 250 g/m <sup>2</sup>	surface grinding (machine)
F – paper	approx. 300 g/m <sup>2</sup>	surface grinding (machine)
G – paper	approx. 400 g/m <sup>2</sup>	surface grinding (machine)
JF – cloth	light, highly flexible	high profiled workpieces (hand and machine)
GX – blended cloth	light, flexible	profiled workpieces (machine)
J – cloth	light, flexible	profiled workpieces (hand and machine)
XF – cloth	heavy, flexible	hand tool belt grinder
X – cloth	heavy, firm	surfaces, edges, rotation bodies (machine)
Y – cloth	heavy, highly firm	surfaces, edges, rotation bodies (machine)
Z – cloth	heavy, highly firm, can be segmented	surface grinding (machine)
Film	polyester film	finish grinding
Fibre	vulcanised fibre	rough and finish grinding

## 2. Base coat

In the base coat step the grit is anchored. The basic bond is the connection between the grit and the backing. It is primarily formed using resin, this provides it with its consistent high quality properties. Glue is only added to a few abrasive papers that are used with hand operated machines and applications.

## 3. Grit

Grit is responsible for stock removal. When selecting the correct grit two properties are particularly important:

- ▶ Bond
- ▶ Toughness

All Klingspor grit types are produced synthetically. This ensures a consistently high quality product. Four different grit types are used with coated abrasives:

- ▶ Silicon carbide
- ▶ Aluminium oxide
- ▶ Zirconia alumina
- ▶ Ceramic aluminium oxide

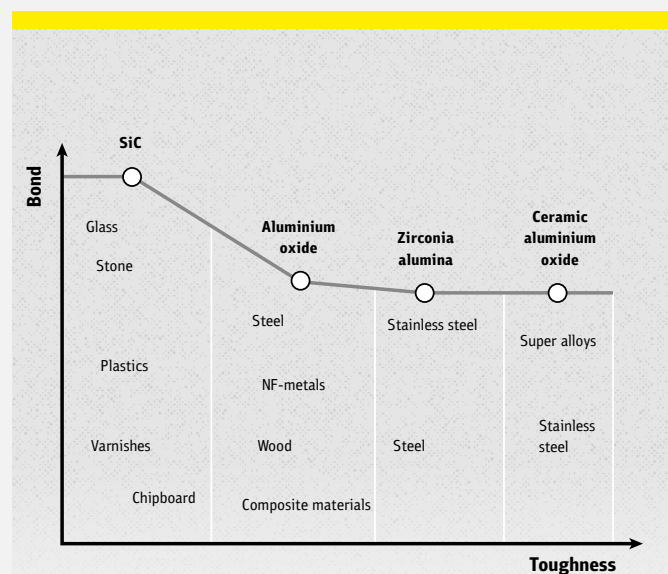

Grit classification in relation to bond, toughness and their primary applications

# Coated abrasives

## Applications guide

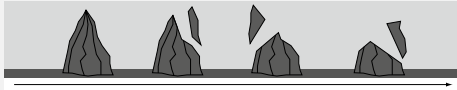
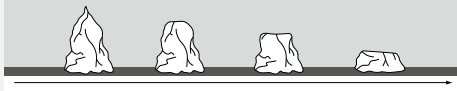
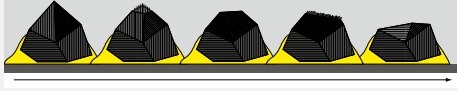
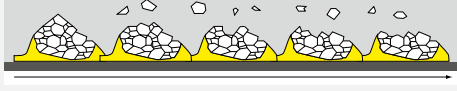
Grain type	Bond / toughness	Structure	Properties / wear properties
<b>Silicon carbide (SiC)</b>	very hard / less tough	crystalline	sharp-edged, brittle, highly friable / micro-wear 
<b>Aluminium oxide</b>	hard / tough	crystalline, irregular	wedge-shaped, block grain, even wear 
<b>Zirconia alumina</b>	hard / very tough	crystalline, even	wedge-shaped, block grain / micro-wear, self-sharpening 
<b>Ceramic aluminium oxide</b>	hard / very tough	micro-crystalline	sharp-edged, pointed grit / micro-wear, self-sharpening 

Grit type properties and their specific wear properties

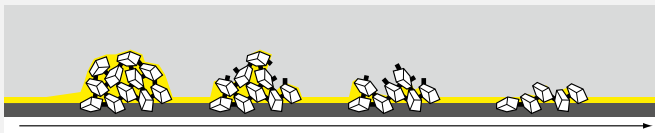

Definition	Description
close coating	The entire surface of the backing is coated with grit
semi-open coating	Approx. 75% of the backing surface is coated with grit
open coating	Approx. 50% of the backing surface is coated with grit

In addition, there are also so-called grit agglomerates. This is not an independent grit type, rather it is a grit agglomeration, which is comprised of many individual aluminium-oxide or SiC-grits mixed with a resin bonding agent, which together form a large grit. Agglomerates are used almost exclusively on abrasive belts.

The advantage of agglomerates is that they provide an even finish from the first use to the last. Dull grit breaks off from the agglomerate and creates space for new, sharp grit. The objective is to attain an even finish through continual stock removal and an extremely long service life.

### Coating

Moreover, the coated abrasives are coated with different grit coverage densities. The term "grit density" describes the grit coverage density distributed on the backing.

One differentiates between:

- ▶ close coating
- ▶ semi-open coating
- ▶ open coating

Open coated grit has a large space between the individual grits, such that the stock removal and the grinding dust can be extracted more easily from the grinding surface. This prevents premature clogging when working on long-chipping materials, such as wood.

The decision as to which grit density to use is primarily dependent upon how great the likelihood is that the grinding dust will clog the space between the grits.

## Grit size chart

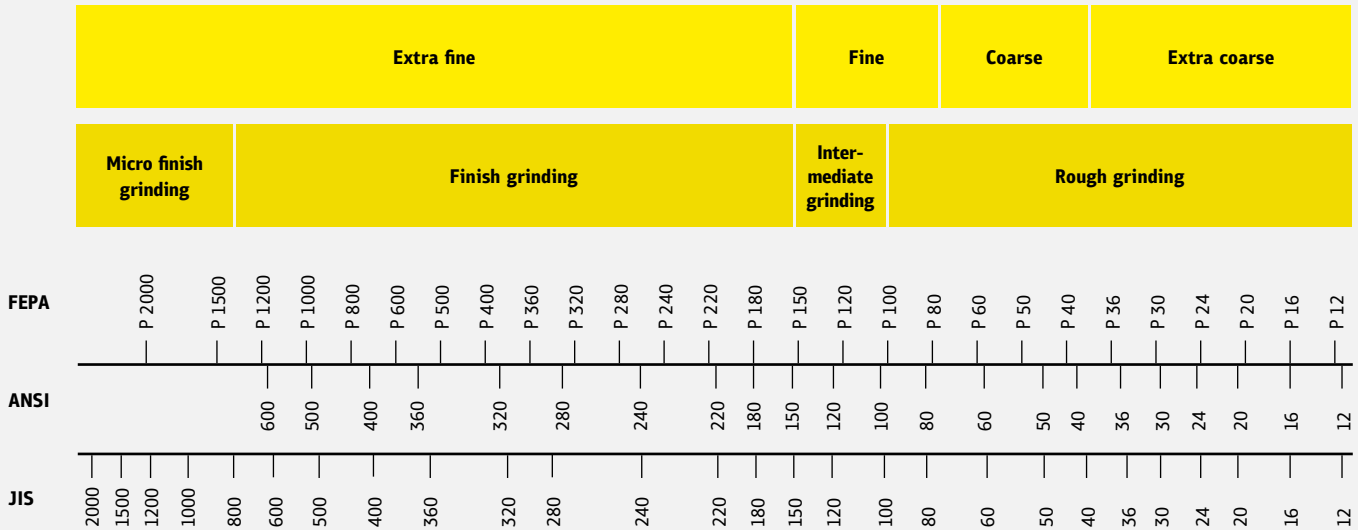

## 4. Size coat

The size coat supports the base coat in the anchoring of the grit on the backing and against forces which affect the grit during grinding. The cover bonds are produced exclusively from resin and also provide the product with its typical colour (exceptions are coated abrasives with additional coatings).

## 5. Special coatings

Special coatings with grinding aids provide the grinding tool properties that positively affect the grinding process and extends the service life of the coated abrasive. Special coatings are applied as an additional layer.

### Stearate coating

The stearate on a coated abrasive prevents the clogging and loading of the belt and is specifically suited for high quality varnish surface applications. Paints, varnishes and plastics can become soft and sticky through the heat generated from grinding, this can result in the premature clogging and loading of the belt. The dust clogs the space between the grits and this can result in additional “negative bond”. This clogs the grits and the sharp edges are no longer effective. To prevent this from happening or to slow the process down, the coated abrasives can be coated with a non-stick material, so-called stearates.

### Multibond

The multibond, like the stearate coating, is applied in an additional production step to the cover bond layer. This allows the cool grinding of stainless steel and high alloy steels, which in turn increases the stock removal rate and service life.

### ACT – Advanced Coating Technology

Klingspor uses this technology to improve the properties of the coated abrasives. When working on metal, ACT provides significantly higher grit adhesion, e.g. for aggressive belt grinding of the edges of punched parts and castings. This significantly increases the life of the grinding belt. For belts that are used for wood and varnish sanding, ACT prevents the premature clogging of the coated abrasives and significantly increases the service life.

### Antistatic

Electrode migration is the result of friction i.e. grinding between different materials, and in turn causes charge separation, which in the case of non-conductive materials, such as wood, results in the load differences not being balanced. In these cases, the coated abrasive is equipped with antistatic properties that ground the electrical charge through the coated abrasive and the machine. This prevents the grinding dust from adhering to the workpiece, belt and machine.





**FACT**  
FACTORY  
ANISTATIC  
MADE IN THE USA



# Rolls



Application	Type	Grain	Backing	Coating	Characteristics	Page
Wood	<b>PS 22 F ACT</b>	Aluminium oxide	F-paper	●	Close coating for maximum stock removal and uniform scratch pattern regarding surface treatment of hard, low-content woods. ACT and antistatic properties prevent premature clogging	20
	<b>PS 22 N</b>	Aluminium oxide	E-paper	○	Abrasive paper with semi-open coating for high stock removal capacity for the processing of wood	21
	<b>PS 29 F ACT</b>	Aluminium oxide	F-paper	○	Abrasive with outstanding service life. Open coat, antistatic properties as well as ACT prevent premature clogging. The abrasive paper is particularly suitable for processing soft and high resin woods	25
	<b>PS 30 D</b>	Aluminium oxide	D-paper	○	Economical abrasive paper for universal applications in the processing of wood and paints	21
	<b>PL 31 B</b>	Aluminium oxide	B-paper	○	Flexible finishing paper with an optimal price-performance ratio for a wide range of applications for the processing of wood, paint and varnish. Provides a smooth surface finish	22
	<b>LS 309 X</b>	Aluminium oxide	X-cotton	●	Multi-purpose abrasive cloth for metal and wood processing, good price-performance ratio	27
	<b>LS 309 JF</b>	Aluminium oxide	JF-cotton	●	Highly flexible abrasive cloth for strongly profiled workpieces, for smooth surfaces in the metal and wood processing	27
	<b>LS 309 JF slashed</b>	Aluminium oxide	JF-cotton	●	Slashed, highly flexible abrasive cloth for strongly profiled workpieces, for smooth surfaces in wood processing, also suitable for light deburring work on metals	28
Wood, Varnish	<b>NRO 500</b>	SiC	Non-woven web	–	Excellent suited to smoothing, cleaning and surface finishing	36
Paint	<b>PS 30 D</b>	Aluminium oxide	D-paper	○	Economical abrasive paper for universal applications in the processing of wood and paints	21
	<b>PL 31 B</b>	Aluminium oxide	B-paper	○	Flexible finishing paper with an optimal price-performance ratio for a wide range of applications for the processing of wood, paint and varnish. Provides a smooth surface finish	22
	<b>PS 33 B</b>	Aluminium oxide	B-paper	○	Flexible finishing paper with an optimal price-performance ratio for a wide range of applications for the processing of wood, paint and varnish. Provides a smooth surface finish	24
	<b>PS 33 C</b>	Aluminium oxide	C-paper	○	Flexible finishing paper with an optimal price-performance ratio for a wide range of applications for the processing of wood, paint and varnish. Provides a smooth surface finish	23
	<b>PS 73 BWF</b>	Aluminium oxide	B-paper + foam core	○	Abrasive pads on rolls for de-nibbing and finishing of surfaces, moulded parts and contours. Foam backing for better pressure distribution and a very fine surface finish. The pads are supplied in a convenient dispenser that allows individual pads to be separated by tearing along the perforation	26
	<b>PS 73 CWF</b>	Aluminium oxide	C-paper + foam core	○	Abrasive pads on rolls for de-nibbing and finishing of surfaces, moulded parts and contours. Foam backing for better pressure distribution and a very fine surface finish. The pads are supplied in a convenient dispenser that allows individual pads to be separated by tearing along the perforation	25
Metals	<b>LS 309 X</b>	Aluminium oxide	X-cotton	●	Multi-purpose abrasive cloth for metal and wood processing, good price-performance ratio	27
	<b>KL 361 JF</b>	Aluminium oxide	JF-cotton	●	High quality, highly flexible abrasive cloth for versatile applications in the metal processing industry, also suitable for stainless steel	28, 30
	<b>KL 385 JF</b>	Aluminium oxide	JF-cotton	●	Highly flexible universal abrasive cloth for the metal processing industry, good price-performance ratio	31, 32
	<b>NRO 400</b>	Aluminium oxide	Non-woven web	–	Perfectly suited for light deburring, cleaning and surface refinement, also suited for stainless steel	35

● = close ○ = semi-open ○ = open

Type	Grit range
<b>PS 22 F ACT</b>	40–150
<b>PS 28 F</b>	60–150
<b>PS 29 F ACT</b>	60–150
<b>CS 308 Y</b>	40–80, 120
<b>LS 309 X</b>	40–360
<b>LS 309 J</b>	60–320
<b>LS 309 JF</b>	60–400
<b>CS 310 X</b>	24–400
<b>CS 310 XF</b>	40–280
<b>LS 312 JF</b>	60–320, 400
<b>CS 321 X</b>	80–400
<b>CS 333 X</b>	60, 80, 120, 150
<b>CS 341 X</b>	50–320
<b>KL 361 JF</b>	40–600
<b>KL 385 JF</b>	40–600
<b>CS 410 X</b>	60–120
<b>CS 411 X</b>	24–120
<b>CS 411 Y</b>	36–80

Paper	
B	approx. 105 g/m <sup>2</sup>
C	approx. 110 g/m <sup>2</sup>
D	approx. 130 g/m <sup>2</sup>
E	approx. 250 g/m <sup>2</sup>
F	approx. 300 g/m <sup>2</sup>
Cloth	
X	Cloth, heavy
J	Cloth, light
JF	Cloth, light, highly flexible
Y	Cloth, heavy, high strength
XF	Cloth, heavy, flexible

## Minimum order quantities for made to order items

Width	Minimum order quantities	Width	Minimum order quantities
10 mm	29 pieces	80 mm	3 pieces
15 mm	19 pieces	95 mm	3 pieces
20 mm	14 pieces	100 mm	3 pieces
25 mm	12 pieces	120 mm	2 pieces
28 mm	10 pieces	125 mm	2 pieces
30 mm	10 pieces	140 mm	2 pieces
35 mm	8 pieces	150 mm	2 pieces
40 mm	7 pieces	250 mm	1 piece
50 mm	6 pieces	300 mm	1 piece
60 mm	5 pieces		



**All other grit sizes, widths and lengths require at least one full jumbo roll to be taken. Please inquire about quantities.**

# Rolls with paper backing

Coated abrasives

Abrasive paper

## PS 22 F ACT



### Properties

Bonding agent	Resin
Grain	Aluminium oxide
Coating	Close
Backing	F-paper

### Applications:

Wood	●	NF metals	○
Metals	○		
Plastic	○		
Steel	○		

**Advantages:** High abrasive performance - Uniform, fine surface scratch pattern - Premium product for use on hardwood, varnish, filler - Long service life and minimal clogging due to ACT recipe - High edge stability

### Available grits:

Width x Length in mm	Grit	Packing unit/pcs.	Cat. number
95 x 50000	60	1	20822
95 x 50000	80	1	20850
95 x 50000	100	1	20884
95 x 50000	120	1	20916
95 x 50000	150	1	20940
95 x 50000	180	1	20960
110 x 50000	40	1	2969
110 x 50000	60	1	2971
110 x 50000	80	1	2972
110 x 50000	100	1	2973
110 x 50000	120	1	2974
110 x 50000	150	1	2975
110 x 50000	180	1	2976
110 x 50000	240	1	2978
115 x 50000	40	1	2983
115 x 50000	60	1	2985
115 x 50000	80	1	2986
115 x 50000	100	1	2987
115 x 50000	120	1	2988
115 x 50000	150	1	2989
115 x 50000	180	1	2990
115 x 50000	220	1	2991
115 x 50000	240	1	2992
150 x 50000	80	1	3014
150 x 50000	100	1	3015
150 x 50000	120	1	3016
200 x 50000	40	1	3053
200 x 50000	60	1	3055
200 x 50000	80	1	3056
200 x 50000	120	1	3058

Other grits and sizes available on request.

Please observe: Minimum order quantities for manufactured items see page 19. Please see Applications Guide on page 19.

# Rolls with paper backing

Coated abrasives



Rolls

Abrasive paper

## PS 22 N



### Properties

Bonding agent	Resin
Grain	Aluminium oxide
Coating	Semi-open
Backing	E-paper

### Applications:

Wood	●	Steel	○
Metals	○		
Paint/Varnish/Filler	○		
Plastic	○		

**Advantages:** Universal product for hand sanding and handheld machine sanding of virtually any material - Large grit range allows use from rough sanding to finishing

### Available grits:

16	24	30	36	40	50	60	80	100	120	150	180	220	240	280	320	360	400	500	600	800	1000	1200	1500	2000
----	----	----	----	----	----	----	----	-----	-----	-----	-----	-----	-----	-----	-----	-----	-----	-----	-----	-----	------	------	------	------

Width x Length in mm	Grit	Packing unit/pcs.	Cat. number
115 x 50000	40	1	244611
115 x 50000	60	1	244612
115 x 50000	80	1	244613
115 x 50000	100	1	244614
115 x 50000	120	1	244615
115 x 50000	150	1	244616
115 x 50000	180	1	244599
115 x 50000	240	1	244597

Abrasive paper

## PS 30 D



### Properties

Bonding agent	Resin
Grain	Aluminium oxide
Coating	Semi-open
Backing	D-paper

### Applications:

Paint/Varnish/Filler	●
Wood	●
Metals	○

**Advantages:** Sharp grit and high aggressiveness for use on wood, varnish, fillers - Flexible and tear resistant, easy folding - Product with good price-performance ratio

### Available grits:

16	24	30	36	40	50	60	80	100	120	150	180	220	240	280	320	360	400	500	600	800	1000	1200	1500	2000
----	----	----	----	----	----	----	----	-----	-----	-----	-----	-----	-----	-----	-----	-----	-----	-----	-----	-----	------	------	------	------

Width x Length in mm	Grit	Packing unit/pcs.	Cat. number
115 x 4500	40	10	174094
115 x 4500	60	10	174095
115 x 4500	80	10	174096
115 x 4500	100	10	174097
115 x 4500	120	10	174098

Other grits and sizes available on request.

Continuation →

Please observe: Minimum order quantities for manufactured items see page 19. Please see Applications Guide on page 19.

# Rolls with paper backing

## Coated abrasives

→ Continuation of PS 30 D, Abrasive paper

Width x Length in mm	Grit	Packing unit/pcs.	Cat. number
115 x 4500	150	10	174099
115 x 4500	180	10	174100
115 x 50000	40	1	174086
115 x 50000	60	1	174088
115 x 50000	80	1	174089
115 x 50000	100	1	174090
115 x 50000	120	1	174091
115 x 50000	150	1	174092
115 x 50000	180	1	174093
115 x 50000	240	1	182418
115 x 50000	320	1	182419

Finishing paper

### PL 31 B



#### Properties

Bonding agent	Glue
Grain	Aluminium oxide
Coating	Semi-open
Backing	B-paper

#### Applications:

Paint/Varnish/Filler	●
Wood	●
Metals	◐

**Advantages:** Product with optimal price-performance ratio - Optimized wear properties for hand sanding and handheld machine sanding

Available grits:

16	24	30	36	40	50	60	80	100	120	150	180	220	240	280	320	360	400	500	600	800	1000	1200	1500	2000
----	----	----	----	----	----	----	----	-----	-----	-----	-----	-----	-----	-----	-----	-----	-----	-----	-----	-----	------	------	------	------

Width x Length in mm	Grit	Packing unit/pcs.	Cat. number
95 x 50000	40	1	3279
95 x 50000	60	1	3281
95 x 50000	80	1	3282
95 x 50000	100	1	3191
95 x 50000	120	1	3192
95 x 50000	180	1	3194
95 x 50000	240	1	3196
110 x 50000	40	1	3287
110 x 50000	60	1	3289
110 x 50000	80	1	3290
110 x 50000	100	1	3213
110 x 50000	120	1	3214
110 x 50000	150	1	3215
110 x 50000	180	1	3216
110 x 50000	220	1	3217
110 x 50000	240	1	3218
110 x 50000	280	1	3219
110 x 50000	320	1	3220
110 x 50000	400	1	3222

Other grits and sizes available on request.

Please observe: Minimum order quantities for manufactured items see page 19. Please see Applications Guide on page 19.

Continuation →

# Rolls with paper backing

Coated abrasives



Rolls

→ Continuation of PL 31 B, Finishing paper

Width x Length in mm	Grit	Packing unit/pcs.	Cat. number
115 x 50000	40	1	3291
115 x 50000	60	1	3293
115 x 50000	80	1	3294
115 x 50000	100	1	3224
115 x 50000	120	1	3225
115 x 50000	150	1	3226
115 x 50000	180	1	3227
115 x 50000	220	1	3228
115 x 50000	240	1	3229
115 x 50000	280	1	3230
115 x 50000	320	1	3231
115 x 50000	400	1	3233

Abrasive paper

## PS 33 C



### Properties

Bonding agent	Resin
Grain	Aluminium oxide
Coating	Semi-open
Backing	C-paper

### Applications:

Paint/Varnish/Filler	●
Wood	●
Plastic	○

**Advantages:** Very high removal rate - Minimal clogging due to active abrasive substances - Longer service life - Good tear resistance and flexibility

Available grits:

16	24	30	36	40	50	60	80	100	120	150	180	220	240	280	320	360	400	500	600	800	1000	1200	1500	2000
----	----	----	----	----	----	----	----	-----	-----	-----	-----	-----	-----	-----	-----	-----	-----	-----	-----	-----	------	------	------	------

Width x Length in mm	Grit	Packing unit/pcs.	Cat. number
110 x 50000	60	1	146981
110 x 50000	80	1	146982
110 x 50000	100	1	146983
110 x 50000	120	1	146386
115 x 50000	60	1	155815
115 x 50000	80	1	147575
115 x 50000	100	1	147576
115 x 50000	120	1	153398

Other grits and sizes available on request.

Please observe: Minimum order quantities for manufactured items see page 19. Please see Applications Guide on page 19.



# Rolls with paper backing

Coated abrasives

Abrasive paper

## PS 33 B



### Properties

Bonding agent	Resin
Grain	Aluminium oxide
Coating	Semi-open
Backing	B-paper

### Applications:

Paint/Varnish/Filler	●
Wood	●
Plastic	○

**Advantages:** Very high removal rate - Minimal clogging due to active abrasive substances - Longer service life - Good tear resistance and flexibility

### Available grits:

16	24	30	36	40	50	60	80	100	120	150	180	220	240	280	320	360	400	500	600	800	1000	1200	1500	2000
----	----	----	----	----	----	----	----	-----	-----	-----	-----	-----	-----	-----	-----	-----	-----	-----	-----	-----	------	------	------	------

Width x Length in mm	Grit	Packing unit/pcs.	Cat. number
110 x 50000	150	1	148494
110 x 50000	180	1	147935
110 x 50000	220	1	148495
110 x 50000	240	1	147114
110 x 50000	280	1	148496
110 x 50000	320	1	147110
110 x 50000	400	1	146387
115 x 50000	150	1	153177
115 x 50000	180	1	149480
115 x 50000	220	1	149698
115 x 50000	240	1	147055
115 x 50000	280	1	165031
115 x 50000	320	1	148891
115 x 50000	400	1	145520

Other grits and sizes available on request.

Please observe: Minimum order quantities for manufactured items see page 19. Please see Applications Guide on page 19.

# Rolls with paper backing

Coated abrasives



Abrasive paper, ANTISTATIC

## PS 29 FACT



### Properties

Bonding agent	Resin
Grain	Aluminium oxide
Coating	Open
Backing	F-paper

### Applications:

Wood	●
Paint/Varnish/Filler	⓪

**Advantages:** High aggressiveness and long service life when used on wood (especially softwood) due to ACT recipe - High edge stability - Premium product for wood in general, varnish and filler

### Available grits:

16 24 30 36 40 50 60 80 100 120 150 180 220 240 280 320 360 400 500 600 800 1000 1200 1500 2000

Width x Length in mm	Grit	Packing unit/pcs.	Cat. number
110 x 50000	80	1	307878
110 x 50000	100	1	307879
110 x 50000	120	1	307880
110 x 50000	150	1	307881
110 x 50000	180	1	307882
115 x 50000	60	1	307884
115 x 50000	80	1	302592
115 x 50000	100	1	307885
115 x 50000	120	1	302591
115 x 50000	150	1	307886

Abrasive paper with foam backing

## PS 73 CWF



### Properties

Bonding agent	Resin
Grain	Aluminium oxide
Coating	Semi-open
Backing	C-paper + foam core

### Applications:

Wood	●
Paint/Varnish/Filler	●
Plastic	●

**Advantages:** Very good distribution of sanding pressure due to elastic and conforming foam backing, therefore preventing over sanding of thin coatings and providing a very fine finish - High flexibility and very good adaptability to contours and profiles - Reduced clogging due to additional stearate coating and semi-open coated grain - Easy handling by tearing handy pads from a pre-perforated roll out of a dispenser box - Dimensions of abrasive pads: 115 x 140 mm, approx. 180 pcs

### Available grits:

16 24 30 36 40 50 60 80 100 120 150 180 220 240 280 320 360 400 500 600 800 1000 1200 1500 2000

Width x Length in mm	Grit	Packing unit/pcs.	Cat. number
115 x 25000	120	1	321755

Other grits and sizes available on request.

Please observe: Minimum order quantities for manufactured items see page 19. Please see Applications Guide on page 19.

# Rolls with paper backing

Coated abrasives

Abrasive paper with foam backing

## PS 73 BWF



### Properties

Bonding agent	Resin
Grain	Aluminium oxide
Coating	Semi-open
Backing	B-paper + foam core

### Applications:

Wood	●
Paint/Varnish/Filler	●
Plastic	●

**Advantages:** Very good distribution of sanding pressure due to elastic and conforming foam backing, therefore preventing over sanding of thin coatings and providing a very fine finish - High flexibility and very good adaptability to contours and profiles - Reduced clogging due to additional stearate coating and semi-open coated grain - Easy handling by tearing handy pads from a pre-perforated roll out of a dispenser box - Dimensions of abrasive pads: 115 x 140 mm, approx. 180 pcs

### Available grits:

16 24 30 36 40 50 60 80 100 120 150 180 220 240 280 320 360 400 500 600 800 1000 1200 1500 2000

Width x Length in mm	Grit	Packing unit/pcs.	Cat. number
115 x 25000	150	1	325711
115 x 25000	180	1	321756
115 x 25000	240	1	321757
115 x 25000	320	1	321758
115 x 25000	400	1	321760
115 x 25000	600	1	325022

Other grits and sizes available on request.

Please observe: Minimum order quantities for manufactured items see page 19. Please see Applications Guide on page 19.

# Rolls with cloth backing

Coated abrasives



Abrasive cloth

## LS 309 X



### Properties

Bonding agent	Resin
Grain	Aluminium oxide
Coating	Close
Backing	X-cotton

### Applications:

Metals	●
Wood	●

**Advantages:** High-quality universal abrasive cloth for diverse applications in metal and woodworking - Good price-performance ratio

Available grits:

16 24 30 36 40 50 60 80 100 120 150 180 220 240 280 320 360 400 500 600 800 1000 1200 1500 2000

All sizes and minimum purchasing quantities available on request

Abrasive cloth

## LS 309 JF



### Properties

Bonding agent	Resin
Grain	Aluminium oxide
Coating	Close
Backing	JF-cotton

### Applications:

Metals	●
Wood	●

**Advantages:** High abrasive performance - Fine surface scratch pattern - Very good adaptation to contours, tight radiuses and profiles due to highly flexible cotton cloth

Available grits:

16 24 30 36 40 50 60 80 100 120 150 180 220 240 280 320 360 400 500 600 800 1000 1200 1500 2000

All sizes and minimum purchasing quantities available on request

Other grits and sizes available on request.

Please observe: Minimum order quantities for manufactured items see page 19. Please see Applications Guide on page 19.

# Rolls with cloth backing

Coated abrasives

Abrasive cloth

## LS 309 JF slashed



### Properties

Bonding agent	Resin
Grain	Aluminium oxide
Coating	Close
Backing	JF-cotton

### Applications:

Metals	●
Wood	●

**Advantages:** Outstanding adaptation for use on turned parts - Individual applications due to different slotting variants

Available grits:

16 24 30 36 40 50 60 80 100 120 150 180 220 240 280 320 360 400 500 600 800 1000 1200 1500 2000

All sizes and minimum purchasing quantities available on request

Abrasive cloth, brown

## KL 361 JF



### Properties

Bonding agent	Resin
Grain	Aluminium oxide
Coating	Close
Backing	JF-cotton

### Applications:

Stainless steel	●	Wood	●
Steel	●	Plastic	○
Metals	●		
NF metals	●		

**Advantages:** High-quality universal abrasive cloth - Optimal adaptation to workpiece contours - Tears off cleanly and easily from the roll

Available grits:

16 24 30 36 40 50 60 80 100 120 150 180 220 240 280 320 360 400 500 600 800 1000 1200 1500 2000

Width x Length in mm	Grit	Packing unit/pcs.	Cat. number
25 x 50000	40	1	3769
25 x 50000	60	1	3771
25 x 50000	80	1	3772
25 x 50000	100	1	3773
25 x 50000	120	1	3774
25 x 50000	150	1	3775
25 x 50000	180	1	3776
25 x 50000	220	1	3777
25 x 50000	240	1	3778
25 x 50000	320	1	3780
25 x 50000	400	1	3782
25 x 50000	600	1	64825
30 x 50000	60	1	3787

Other grits and sizes available on request.

Continuation →

Please observe: Minimum order quantities for manufactured items see page 19. Please see Applications Guide on page 19.

# Rolls with cloth backing

Coated abrasives



Rolls

→ Continuation of KL 361 JF, Abrasive cloth, brown

Width x Length in mm	Grit	Packing unit/pcs.	Cat. number
30 x 50000	80	1	91286
30 x 50000	100	1	3789
30 x 50000	120	1	3790
30 x 50000	150	1	3791
30 x 50000	180	1	3792
30 x 50000	240	1	3794
30 x 50000	320	1	3796
30 x 50000	400	1	3798
40 x 25000	40	1	4201
40 x 25000	50	1	4202
40 x 25000	60	1	4203
40 x 25000	80	1	4204
40 x 25000	100	1	4205
40 x 25000	120	1	4206
40 x 25000	150	1	4207
40 x 25000	180	1	4208
40 x 25000	220	1	4209
40 x 25000	240	1	4210
40 x 25000	320	1	4212
40 x 25000	400	1	4214
40 x 50000	40	1	3833
40 x 50000	60	1	3835
40 x 50000	80	1	3836
40 x 50000	100	1	3837
40 x 50000	120	1	3838
40 x 50000	150	1	3839
40 x 50000	180	1	3840
40 x 50000	220	1	3841
40 x 50000	240	1	3842
40 x 50000	280	1	3843
40 x 50000	320	1	3844
40 x 50000	360	1	3845
40 x 50000	400	1	3846
40 x 50000	600	1	64830
50 x 25000	40	1	4217
50 x 25000	60	1	4219
50 x 25000	80	1	4220
50 x 25000	100	1	4221
50 x 25000	120	1	4222
50 x 25000	150	1	4223
50 x 25000	180	1	4224
50 x 25000	220	1	4225
50 x 25000	240	1	4226
50 x 25000	320	1	4228
50 x 25000	400	1	4230
50 x 25000	600	1	64831
50 x 50000	40	1	3849
50 x 50000	50	1	3850
50 x 50000	60	1	3851
50 x 50000	80	1	3852
50 x 50000	100	1	3853

Other grits and sizes available on request.

Continuation →

Please observe: Minimum order quantities for manufactured items see page 19. Please see Applications Guide on page 19.



# Rolls with cloth backing

## Coated abrasives

→ Continuation of KL 361 JF, Abrasive cloth, brown

Width x Length in mm	Grit	Packing unit/pcs.	Cat. number
50 x 50000	120	1	3854
50 x 50000	150	1	3855
50 x 50000	180	1	3856
50 x 50000	220	1	3857
50 x 50000	240	1	3858
50 x 50000	280	1	3859
50 x 50000	320	1	3860
50 x 50000	360	1	3861
50 x 50000	400	1	3862
50 x 50000	500	1	3863
50 x 50000	600	1	64832

Abrasive cloth, brown

### KL 361 JF



#### Properties

Bonding agent	Resin
Grain	Aluminium oxide
Coating	Close
Backing	JF-cotton

#### Applications:

Stainless steel	●	Wood	●
Steel	●	Plastic	⊙
Metals	●		
NF metals	●		

**Advantages:** High-quality universal abrasive cloth - Optimal adaptation to workpiece contours - Tears off cleanly and easily from the roll

Available grits:

16 24 30 36 40 50 60 80 100 120 150 180 220 240 280 320 360 400 500 600 800 1000 1200 1500 2000

Width x Length in mm	Grit	Packing unit/pcs.	Cat. number
80 x 50000	80	1	3900
80 x 50000	120	1	3902
80 x 50000	150	1	3903
100 x 50000	40	1	3913
100 x 50000	50	1	3914
100 x 50000	60	1	3915
100 x 50000	80	1	3916
100 x 50000	100	1	3917
100 x 50000	120	1	3918
100 x 50000	150	1	3919
100 x 50000	180	1	3920
100 x 50000	220	1	3921
100 x 50000	240	1	3922
100 x 50000	320	1	3924
100 x 50000	400	1	3926
100 x 50000	600	1	64835
110 x 50000	40	1	3929
110 x 50000	60	1	3931
110 x 50000	80	1	3932

Other grits and sizes available on request.

Continuation →

Please observe: Minimum order quantities for manufactured items see page 19. Please see Applications Guide on page 19.

# Rolls with cloth backing

Coated abrasives



Rolls

→ Continuation of KL 361 JF, Abrasive cloth, brown

Width x Length in mm	Grit	Packing unit/pcs.	Cat. number
110 x 50000	100	1	3933
110 x 50000	120	1	3934
110 x 50000	180	1	3936
110 x 50000	240	1	3938
115 x 50000	40	1	3945
115 x 50000	60	1	3947
115 x 50000	80	1	3948
115 x 50000	100	1	3949
115 x 50000	120	1	3950
115 x 50000	150	1	3951
115 x 50000	180	1	3952
115 x 50000	240	1	3954
115 x 50000	320	1	3956
120 x 50000	60	1	3963
120 x 50000	80	1	3964
120 x 50000	100	1	3965
120 x 50000	120	1	3966
120 x 50000	180	1	3968
150 x 50000	40	1	3977
150 x 50000	60	1	3979
150 x 50000	80	1	3980
150 x 50000	100	1	3981
150 x 50000	120	1	3982
150 x 50000	150	1	3983

Abrasive cloth, brown

## KL 385 JF



### Properties

Bonding agent	Resin
Grain	Aluminium oxide
Coating	Close
Backing	JF-cotton

### Applications:

Metals	●
NF metals	●
Stainless steel	⦿
Plastic	⦿
Wood	⦿

**Advantages:** Attractively priced universal product for profile grinding - Optimal adaptation to workpiece contours - Tears off cleanly and easily from the roll

Available grits:

- 16 24 30 36 40 50 60 80 100 120 150 180 220 240 280 320 360 400 500 600 800 1000 1200 1500 2000

Width x Length in mm	Grit	Packing unit/pcs.	Cat. number
25 x 50000	60	1	218196
25 x 50000	80	1	218197
25 x 50000	100	1	218198
25 x 50000	120	1	218199
40 x 50000	40	1	218077
40 x 50000	60	1	218079

Other grits and sizes available on request.

Continuation →

Please observe: Minimum order quantities for manufactured items see page 19. Please see Applications Guide on page 19.

# Rolls with cloth backing

## Coated abrasives

→ Continuation of KL 385 JF, Abrasive cloth, brown

Width x Length in mm	Grit	Packing unit/pcs.	Cat. number
40 x 50000	80	1	218080
40 x 50000	100	1	218081
40 x 50000	120	1	218082
40 x 50000	150	1	218083
40 x 50000	180	1	218084
40 x 50000	220	1	218085
40 x 50000	240	1	218086
40 x 50000	320	1	218088
40 x 50000	400	1	218090
50 x 50000	40	1	218094
50 x 50000	60	1	218096
50 x 50000	80	1	218097
50 x 50000	100	1	218098
50 x 50000	120	1	218099
50 x 50000	150	1	218100
50 x 50000	180	1	218101
50 x 50000	220	1	218102
50 x 50000	240	1	218103
50 x 50000	320	1	218105
50 x 50000	400	1	218107

Abrasive cloth, brown

## KL 385 JF



### Properties

Bonding agent	Resin
Grain	Aluminium oxide
Coating	Close
Backing	JF-cotton

### Applications:

Metals	●	Wood	⓪
NF metals	●		
Stainless steel	⓪		
Plastic	⓪		

**Advantages:** Attractively priced universal product for profile grinding - Optimal adaptation to workpiece contours - Tears off cleanly and easily from the roll

### Available grits:

16	24	30	36	40	50	60	80	100	120	150	180	220	240	280	320	360	400	500	600	800	1000	1200	1500	2000
----	----	----	----	----	----	----	----	-----	-----	-----	-----	-----	-----	-----	-----	-----	-----	-----	-----	-----	------	------	------	------

Width x Length in mm	Grit	Packing unit/pcs.	Cat. number
115 x 5000	60	1	278789
115 x 5000	80	1	278790
115 x 5000	120	1	278791
115 x 5000	320	1	278792
115 x 50000	40	1	224650
115 x 50000	60	1	228151
115 x 50000	80	1	228363
115 x 50000	100	1	228364
115 x 50000	120	1	228365
115 x 50000	150	1	228370

Other grits and sizes available on request.

Continuation →

Please observe: Minimum order quantities for manufactured items see page 19. Please see Applications Guide on page 19.

# Rolls with cloth backing

Coated abrasives



→ Continuation of KL 385 JF, Abrasive cloth, brown

Width x Length in mm	Grit	Packing unit/pcs.	Cat. number
115 x 50000	180	1	228366
115 x 50000	240	1	228367
115 x 50000	320	1	228368
115 x 50000	400	1	228369

ROLL-BOX

## ROLL-BOX



**Advantages:** Handy and saves storage of economy rolls - Abrasive tears off cleanly and easily - Quick and simple replacement of rolls - For 5 rolls with a width of 50 mm each - For set-up or attachment to the wall

**Abrasives not included**

Width x Length x Height in mm	Packing unit/pcs.	Cat. number
300 x 340 x 230	1	76403

Graphite coated canvas

## CS 395 X

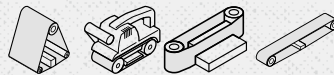

### Properties

Grain	Graphite
Coating	Lamellar
Backing	X-cloth
Thickness	1,5 mm



**Advantages:** Reduces friction between the back side of the belt and the contact element - Reduces heat generation during the grinding process - Enables a smooth and constant grinding

**No self-fastening support**

All sizes and minimum purchasing quantities available on request

Other grits and sizes available on request.

Please observe: Minimum order quantities for manufactured items see page 19. Please see Applications Guide on page 19.

## Self-fastening support

Self-fastening support

### CS 396 Y



#### Properties

Engaging elements	Mushroom heads
Thickness	1,5 mm
Temperature range	-30° to +80°

**Advantages:** Can be cut to size easily - Simple and safe fixing on smooth and even surfaces - Allows a quick change of the abrasive

All sizes and minimum purchasing quantities available on request



# Rolls, non-woven web

Coated abrasives



Non-woven web roll

## NRO 400



### Properties

Bonding agent	Resin
Grain	Aluminium oxide

### Applications:

Stainless steel	●	Paint/Varnish/Filler	●
Metals	●		
Wood	●		
Plastic	●		

**Advantages:** Very good adaptation to surface contours - No clogging - Ideal for smoothing, cleaning, roughening and for general surface finishing - Can be used wet and dry

Width x Length in mm	Colour	Grade	Packing unit/pcs.	Cat. number
100 x 10000	maroon	medium	1	258870
100 x 10000	dark green	very fine	1	258871
100 x 10000	maroon	fine	1	258872
100 x 10000	maroon	very fine	1	258873
115 x 10000	maroon	medium	1	258885
115 x 10000	dark green	very fine	1	258886
115 x 10000	maroon	fine	1	258887
115 x 10000	maroon	very fine	1	258888
150 x 10000	maroon	medium	1	258890
150 x 10000	dark green	very fine	1	258891
150 x 10000	maroon	fine	1	258892
150 x 10000	maroon	very fine	1	258893

Information regarding grit range see chart on page 36.

Other grades and sizes available on request.  
Please observe: Please see Applications Guide on page 19.

# Rolls, non-woven web

Coated abrasives

Non-woven web roll

## NRO 500



### Properties

Bonding agent	Resin
Grain	SiC

### Applications:

Stainless steel	●	Wood	ⓘ
Plastic	●		
Paint/Varnish/Filler	●		
Metals	ⓘ		

**Advantages:** Very good adaptation to surface contours - No logging - Ideal for smoothing, cleaning, roughening and for general surface finishing - Can be used wet and dry

Width x Length in mm	Colour	Grade	Packing unit/pcs.	Cat. number
100 x 10000	black	medium	1	260365
100 x 10000	grey	ultra fine	1	258874
115 x 10000	black	medium	1	260366
115 x 10000	grey	ultra fine	1	258889
150 x 10000	black	medium	1	260367
150 x 10000	grey	ultra fine	1	258894

Grit	120 - 150	180 - 220	240 - 320	800 - 1000
Grade	medium	fine	very fine	ultra fine
Klingspor non-woven web rolls	medium SiC - black			
	medium A - maroon			
		fine A - maroon		
			very fine GP - dark green	
				very fine A - maroon

Aggressiveness decreasing

Other grits and sizes available on request.  
Please observe: Please see Applications Guide on page 19.

# Notes



---

A large grid of small dots for taking notes.



# Abrasive belts



## About the product

### Applications guide

- ▶ Suitable for all sanding and grinding operations: with unsupported belt, sander pad and contact wheel
- ▶ Special designs for customised applications, e.g. for furniture production to enable fast and clean preparation of large surfaces ready for painting
- ▶ Wide range of sizes
- ▶ Backings made of paper, cloth and film
- ▶ Superior tear resistance of all products

Application	Type	Grain	Backing	Coating	Characteristics	Page
Steel	<b>LS 309 J</b>	Aluminium oxide	J-cotton	●	Flexible abrasive cloth for processing slightly profiled workpieces, high stock removal rate, particularly suited for metal	59
	<b>LS 309 JF</b>	Aluminium oxide	JF-cotton	●	Highly flexible abrasive cloth for highly profiled workpieces for the manufacture of fine surfaces in metal and woodworking	60
	<b>LS 309 X</b>	Aluminium oxide	X-cotton	●	Universal abrasive cloth for metal and woodworking, good price-performance ratio	46, 58
	<b>LS 309 XH</b>	Aluminium oxide	X-cotton	●	Standard quality for portable belt sanders, especially suited for the processing of metal, wood, paint and varnish	51
	<b>CS 310 X</b>	Aluminium oxide	X-cotton	●	Abrasive cloth for metal and woodworking with stable cloth backing, for heavy duty with particularly long service life	60, 76, 77, 90
	<b>CS 341 X</b>	Aluminium oxide	X-cotton waterproof	●	Waterproof abrasive cloth for wet grinding on steel and stainless steel, particularly suited for centreless and surface grinding	67, 94
	<b>CS 308 Y</b>	Aluminium oxide	Y-polyester	●	Polyester abrasive cloth with close coating for working with metal and surface grinding of hardwood	58, 90
Stainless steel	<b>PS 61 F</b>	Ceramic aluminium oxide	F-paper	●	Close coating, tear resistant backing and continuously self-sharpening ceramic grain, the perfect product for users with highest demands on service life, high stock removal rate and process reliability, for the processing of stainless steel surfaces	56, 88
	<b>LS 312 JF</b>	Aluminium oxide	JF-cotton	●	Highly versatile and flexible premium product for stainless steel components such as fixtures, fittings and surgical instruments	62
	<b>LS 313 JF</b>	Aluminium oxide	JF-cotton	●	Highly flexible high quality product for stainless steel shaped parts, additional multibond for cool grinding and long service life	62
	<b>CS 931 JF</b>	Ceramic aluminium oxide	JF-cotton	⦿	Special product with highly flexible backing for use on stainless steel and high alloy steels. Continuously aggressive abrasive performance with a long service life due to semi-open coated self-sharpening ceramic grit. Multibond for cool grinding with no discolouration	74
	<b>GX 931 JF</b>	Ceramic aluminium oxide	JF-blended cloth	⦿	Special highly flexible tear resistant polyester / cotton backed product for stainless steel and high alloy steels; ideal for robot applications. Micro-crystalline ceramic grit with multibond for "cool grinding" and continuously aggressive abrasive performance	74
	<b>GX 712 JF</b>	Aluminium oxide	JF-blended cloth	●	High performance belt with highly flexible, but nonetheless equipped with extremely tear resistant blended cloth backing, tempered aluminium oxide and coated materials	72
	<b>CS 329 JF</b>	Aluminium oxide agglomerate	JF-cotton	●	Long life belt with particular long service life and constant scratch pattern. Special product for the dry grinding of slightly and strongly profiled parts in the stainless steel processing industry	65
	<b>CS 631 XF</b>	Ceramic aluminium oxide	XF-cotton	⦿	Flexible highly efficient belt for best grinding performance, long service life through self-sharpening ceramic grain for rough and intermediate grinding of contours, profiles and fittings, with multibond for cool grinding	71
	<b>CS 410 X</b>	Aluminium oxide	X-cotton	●	Abrasive material with stable cloth backing, multibond for long service life, especially suited for stainless steel processing	68
	<b>CS 411 X</b>	Zirconia alumina	X-cotton	●	High performance belt with high stock removal rate for rough grinding and deburring of steel and stainless steel	68
	<b>CS 411 Y</b>	Zirconia alumina	Y-polyester	●	Particularly tear resistant high performance belt with high stock removal rate for rough grinding and deburring of stainless steel and steel	47, 69, 95
	<b>CS 416 Y</b>	Zirconia alumina	Y-polyester	⦿	Extra tear resistant abrasive belt with high stock removal rates for grinding steel and stainless steel with a semi-open coating	70
	<b>CS 409 Y</b>	Zirconia alumina	Y-polyester	●	Extremely tear resistant high performance belt with high stock removal efficiency and long service life due to additional multibond, for stainless steel and high alloy steels, cool grinding	67, 95

● = close   ⦿ = semi-open   ○ = open

Continuation →



# Abrasive belts

## Applications guide

Application	Type	Grain	Backing	Coating	Characteristics	Page
Stainless steel	<b>CS 912 Y ACT</b>	Ceramic aluminium oxide	Y-polyester	●	Extremely tear resistant high performance belt with self-sharpening ceramic grain for high stock removal efficiency and long service life for processing high alloy steels	<b>49, 73, 97</b>
	<b>CS 910 Y ACT</b>	Ceramic aluminium oxide	Y-polyester	●	Extremely tear resistant high performance belt with self-sharpening ceramic grain for high stock removal efficiency and long service life for processing high alloy steels, multibond for cool grinding	<b>73</b>
	<b>CS 330 X</b>	SiC / cork	X-cotton waterproof	●	Special belt for steel and stainless steel on surface belt grinders and circular grinding machines, particularly suitable for satin polishing and finishing	<b>66, 93</b>
	<b>CS 326 Y</b>	Aluminium oxide agglomerate	Y-polyester		Long life belt for wet grinding with extremely long service and uniform scratch pattern for centreless circular and surface grinding	<b>65, 92</b>
	<b>CS 329 Y</b>	Aluminium oxide agglomerate	Y-polyester		Long life belt with very long service life and constant surface finish for centreless circular and surface grinding. Aggressive grinding behaviour with low tool pressure	<b>65, 93</b>
	<b>CS 420 Y</b>	Aluminium oxide agglomerate	Y-polyester		Special product with cylindrical-shaped structured abrasive grain for the centreless finishing of stainless steel. Very long service life and uniform scratch pattern	<b>71</b>
	<b>CS 325 Y</b>	SiC agglomerate	Y-polyester		Long life belt with very long service life and constant surface finish for centreless finishing	<b>64</b>
	<b>CS 811 Y ACT</b>	Zirconia alumina	Y-polyester	●	Excellent grain adhesion, stable, highly tear resistant polyester backing for particularly high duty during rough grinding and deburring of steel and stainless steel. High quality zirconia alumina for highest aggressiveness over the complete service life	<b>73</b>
	<b>NBF 800</b>	Aluminium oxide	Non-woven web with polyester insert		Special product for working metal and stainless steel surfaces with a tool belt grinder. Very long service life, no premature clogging, high edge stability, tear resistant belt joint	<b>49</b>
	<b>NBS 800</b>	Aluminium oxide	Non-woven web with polyester insert		Structure as for NBF 800, though for handheld machines with larger pulleys and stationary belt sanders	<b>75</b>
Steel / Stainless steel	<b>PS 20 F</b>	Aluminium oxide	F-paper	●	Close coating and heavy, tear resistant backing for high stock removal rate and a long service life for metalworking	<b>53, 84</b>
	<b>PS 21 F</b>	Zirconia alumina	F-paper	●	Close coating, tear resistant backing and high quality, self-sharpening zirconia alumina grain for a long service life and high grinding performance particularly on stainless steel surfaces	<b>53, 84</b>
	<b>PS 729 F</b>	Aluminium oxide agglomerate	F-paper		Long life belt for dry grinding applications, for a constant surface quality for pre-grinding until finishing. Specially developed for coil and sheet grinding with intermediate contact pressure	<b>56, 89</b>
	<b>CS 412 Y</b>	Aluminium oxide	Y-polyester	●	Sturdy and highly tear resistant polyester backing for coarse and intermediate grinding on metal	<b>70, 96</b>
	<b>CS 310 XF</b>	Aluminium oxide	XF-cotton	●	Flexible abrasive cloth for profiled metal formed parts, standard quality for use with hand tool belt grinders	<b>46</b>
	<b>CS 411 X</b>	Zirconia alumina	X-cotton	●	High performance belt with high stock removal rate for rough grinding and deburring of steel and stainless steel	<b>68</b>
	<b>CS 411 Y</b>	Zirconia alumina	Y-polyester	●	Particularly tear resistant high performance belt with high stock removal rate for rough grinding and deburring of stainless steel and steel	<b>47, 69, 95</b>
	<b>CS 416 Y</b>	Zirconia alumina	Y-polyester	○	Extra tear resistant abrasive belt with high stock removal rates for grinding steel and stainless steel with a semi-open coating	<b>70</b>
	<b>CS 330 X</b>	SiC / cork	X-cotton waterproof	●	Special belt for steel and stainless steel on surface belt grinders and circular grinding machines, particularly suitable for satin polishing and finishing	<b>66, 93</b>
	<b>CS 710 XF</b>	Aluminium oxide	XF-cotton	●	Flexible abrasive belt with hardened aluminium oxide grains for working on surfaces and moulded parts.	<b>48, 72</b>
	<b>CS 811 Y ACT</b>	Zirconia alumina	Y-polyester	●	Excellent grain adhesion, stable, highly tear-resistant polyester backing for particularly high duty during rough grinding and deburring of steel and stainless steel. High quality zirconia alumina for highest aggressiveness over the complete service life	<b>73</b>
NF metals	<b>CS 333 JF</b>	SiC	JF-cotton	●	Highly flexible abrasive belt for metal shaped parts, particularly suited for NF metals	<b>67</b>
	<b>CS 333 XF</b>	SiC	XF-cotton	●	Flexible abrasive belt for metal shaped parts, particularly for NF metals	<b>66</b>
	<b>GX 533 JF</b>	SiC	JF-blended cloth	●	Flexible belt with aggressive, hard SiC grit and flexible blended cloth backing for grinding profiles, contours and formed/shaped parts, e.g. fittings	<b>71</b>
	<b>GX 712 JF</b>	Aluminium oxide	JF-blended cloth	●	High performance belt with highly flexible, but nonetheless equipped with extremely tear resistant blended cloth backing, tempered aluminium oxide and coated materials	<b>72</b>
	<b>LS 314 JF</b>	Aluminium oxide	JF-cotton	●	Flexible abrasive belt with hardened aluminium oxide grains for working on surfaces and moulded parts.	<b>63</b>
Wood	<b>PS 22 F ACT</b>	Aluminium oxide	F-paper	●	Close coating for maximum stock removal and uniform scratch pattern regarding surface treatment of hard, low content woods. Advanced Coating Technology (ACT) and antistatic properties prevent premature clogging	<b>53, 85</b>
	<b>PS 28 F</b>	Aluminium oxide	F-paper	○	Open coating and antistatic properties prevent premature clogging of the belt with grinding dust, sturdy, tear resistant backing, for all kinds of wood, particularly soft and high resin woods, e.g. spruce, pine	<b>54, 86</b>
	<b>PS 29 F ACT</b>	Aluminium oxide	F-paper	○	Abrasive belt with outstanding service life. Open coating, antistatic properties as well as Advanced Coating Technology (ACT) prevent premature clogging. The abrasive paper is particularly suitable for processing soft and high resin woods	<b>55, 87</b>
	<b>PS 38 G ACT</b>	SiC	G-paper	●	Special product with very strong and robust G-weight paper backing, excellent antistatic properties and sharp-edged silicon carbide grain, for finishing of particle boards and fibreboards	<b>88</b>

● = close ○ = semi-open ○ = open

Continuation →

# Abrasive belts

## Applications guide



Application	Type	Grain	Backing	Coating	Characteristics	Page
Wood	<b>LS 309 X</b>	Aluminium oxide	X-cloth	●	Universal abrasive cloth for metal and woodworking, good price-performance ratio	<b>46, 58</b>
	<b>LS 309 XH</b>	Aluminium oxide	X-cloth	●	Standard quality for portable belt sanders, especially suited for the processing of metal, wood, paint and varnish	<b>51</b>
	<b>CS 311 Y ACT</b>	Aluminium oxide	Y-polyester	○	Aluminium oxide quality with an open coating on tear resistant polyester backing for calibration and intermediate grinding when working with wood	<b>61, 91</b>
	<b>CS 308 Y</b>	Aluminium oxide	Y-polyester	●	Polyester abrasive cloth with close coating for working with metal and surface grinding of hardwood	<b>58, 90</b>
	<b>LS 318 JF ACT</b>	Aluminium oxide	JF-cloth	○	Highly flexible J-Flex backing for intermediate sanding and finishing of highly profiled and curved wooden parts. Advanced Coating Technology (ACT) and antistatic properties prevent premature clogging	<b>63</b>
	<b>CS 538 Z ACT</b>	SiC	Z-polyester (can be segmented)	●	Special product for the timber products industry. A close coating and antistatic technology ensure an optimal service life. The sharp silicon carbide easily penetrates high density material surfaces	<b>96</b>
	<b>CS 336 Y</b>	SiC	Y-polyester	●	Special product for calibrating and grinding of chipboard	<b>94</b>
Paint / Varnish / Filler	<b>PS 24 F ACT</b>	SiC	F-paper	●	Close coating, a stable backing with hard silicon carbide grit for painted and coated surfaces in the timber and especially the furniture industry	<b>54, 85</b>
	<b>PS 27 DW</b>	SiC	D-paper	○	Open coating and a special stearate coating prevent premature clogging and loading of the belt. Special product for high quality varnish surfaces, particularly UV varnish	<b>54, 86</b>
	<b>FP 73 W</b>	Aluminium oxide	Film	●	Special product with very tear resistant film backing for the processing of paint, varnish and filler with high service life through additional special coating	<b>57</b>
Plastic	<b>GX 533 JF</b>	SiC	JF-blended cloth	●	Flexible belt with aggressive, hard SiC grit and flexible blended cloth backing for grinding profiles, contours and formed/shaped parts, e.g. fittings	<b>71</b>
Glass	<b>CS 322 X</b>	(Cork)	X-cloth waterproof		Special belt for polishing glass	<b>64</b>
Plastic / Glass	<b>CS 333 X</b>	SiC	X-cloth	●	Abrasive cloth with tear resistant backing for heavy duty and long service life for the processing of glass, ceramics, plastic and scale (dry grinding)	<b>66</b>
	<b>CS 320 Y</b>	SiC	Y-polyester	●	Highly tear resistant special belt for high demands for wet and dry grinding of glass, ceramic and plastic	<b>63, 91</b>
	<b>CS 321 X</b>	SiC	X-cloth	●	Special belt for wet and dry grinding of glass, ceramic and plastic	<b>64, 92</b>

● = close   ● = semi-open   ○ = open

Belts

### Minimum order quantities for made to order items

Width	Minimum order quantities
3–50 mm	30 pieces
51–60 mm	25 pieces
61–75 mm	20 pieces
76–100 mm	15 pieces
101–150 mm	10 pieces
151–300 mm	10 pieces
301–400 mm	30 pieces
401 mm and wider	10 pieces

### Minimum order quantities NBF 800

Width	Minimum order quantities
6 – 13 mm	20 pieces
14 – 30 mm	10 pieces

### Minimum order quantities NBS 800

Width	Minimum order quantities
31 – 75 mm	5 pieces
76 – 320 mm	2 pieces



**On principle, master belts are cut up in 300 mm pieces so additional quantities, delivery of which has to be taken, or short shipments can occur.**

# Short and long belts

Applications guide

## Belt joints for long and short belts

Klingspor supplies belts with various types of joints. The type of joint you require depends on the work involved and the machine you are using. The following illustrations show the usual types of joint.

The available types of joint are listed in the product charts on the following product pages.

**If the product you require is not in stock, we will manufacture it for you subject to a minimum order quantity.**



**Type 1**  
Diagonal cut, glued overlapped.

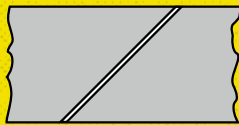

**Type 5**  
Overlapping glued joint. Grit zone is completely ground off. Preferred joint for wood finishes with flat contact elements.

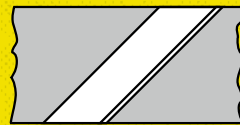

**Type 2**  
Diagonal cut, glued overlapped. Grain tips are completely removed from the overlap to provide for a smoother running belt.

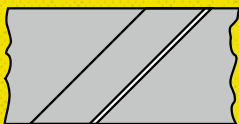

**Type 6 G**  
Diagonal cut, butt joint with cloth-reinforced foil glued on grit side. Grit zone is completely ground off. Use on machines with planar contact elements.

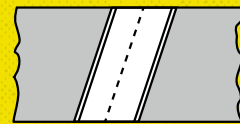

**Type 3 G**  
Zig zag joint, with cloth-reinforced foil backing, impact-free working at very sensitive parts, in particular glass.

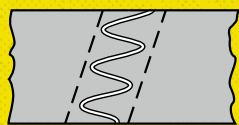

**Type 7 G**  
Sine joint, with cloth-reinforced foil backing, impact-free working at very sensitive parts, for demanding requirements.

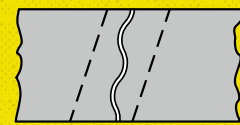

**Type 4 G**  
Diagonal cut. Butt joint with cloth-reinforced foil backing. Also suitable for working on unsupported belts, for demanding requirements.

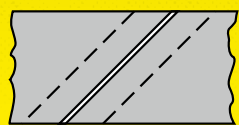

**Type 3 W**  
Special belt joint for non-woven web belts. Tape reinforced butt joint with additional frontal adhesion.

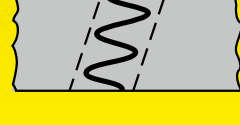

**Type 4 W**  
Bevel cut, butt joint, fabric-reinforced film and bonding on the face side. Special joint for non-woven file belts, product type NBF 800.

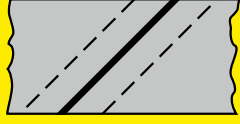

The chart alongside contains all the standard types of machines. Please contact us if you cannot find the machine used by you on this list. We will be pleased to assist you further.

# Short and long belts

Applications guide



## Pad/stroke, edge and profile sanding machines

Manufacturer	Type	Abrasive belt size	
		Width in mm	Length in mm
<b>Bütfering</b>	E-Line 113	370	1900
<b>CMC</b>	KL 150	150	2250
	KL 150 05	150	2400
	CL 260	120/150	7050
	CL 300	120/150	7850
<b>Fein</b>	GX 75/75 2H, GXC, GI 75/75 2H, GIS 75	75	2000
	GXR	75	2250
	GICS	75	3000
	GIM, GIC	75/150	2000
	GI 100	100	1000
	GI 150/150 2 H, GIL, GIS 150	150	2000
	GIR	150	2250
<b>Flott</b>	TBSM 75	75	1000
	BSM 75, BSM E1, BSM 75 A, BSM 75 A/POL	75	2000
	BSM 150, BSM 150 A, BSM 150 A/pol	150	2000
	KSM 150, KSM 250, KOS 150	150	2250
	KOS 250	250	2250
<b>Greif</b>	S 40	max. 100	3500
	D30 HFS 100	max. 100	2000
	D30 HFS 100/150	100/150	2500
	R 40 HFS 150/200	200	3500
	D 20-2-2	30-50	1250
	D 30-2-2	50-100	2500
	D 40-2-2	50-100	3500
<b>Heesemann</b>	SZ 2	60	2300
	UKP 20	80	2300
	HG-U	220	2000
	FPA 8	130	1900
	KFA, MFA 10	150	5400
	MFA 10	150	7000
	MFA 10	1400	2620/3250
BA 2-2300	150	8500	
<b>Hema</b>	HWS 200	20	1810
	KB 202	20	2040
	BB 315/S+P	25	2220
	BB 315/3+3P	25	3150
	SR 400	25	3320
	SR 500	25	4080
	SR 600/UH 630	25	4500
	TBS 3000	120	1200
	PSM 300	25/50	2360
<b>Hess</b>	Junior, Expert	200	1850
	Gloria	200	1600

Manufacturer	Type	Abrasive belt size		
		Width in mm	Length in mm	
<b>Holzmann</b>	MSM 75	75	2000	
	DSM 100200B	100	915	
	MSM 100 L	100	1220	
	MSM 150, KS 2000	150	2000	
	BT 1220	150	1220	
	KOS 2260	150	2260	
	KOS 2510	150	2510	
	KOS 2600P, KOS 2600 C	150	2600	
	KOS 2740	150	2740	
	BS 2000 XL, BS 2400 XL	150	6000	
<b>Holzskraft</b>	PB 2400, PBVN 2400, BS 2400, BKS 2400 XL, BSM 2600 P	150	6800	
	KOS 3000 P	200	3000	
	BTS 200	152	1219	
	Unilev 150	150	2170	
	KSM 801, KSO 150	150	2200	
	KSO 81	150	2250	
	KSO 1500	150	2280	
	LBSM 2505	150	6400	
	LBSM 2505 ESE	150	7000	
	LBSM LS 2500	150	7100	
<b>Johannsen</b>	LBSM 3005 ESE	150	8000	
	LBSM LS 3000	150	8100	
	KSO 200	200	2200	
	T 47	max. 150	2800	
	T 48	200	3000	
	T 93 Start	150	7400	
	T 94 Standard, T 94 Super, T 85, T 95 Profi, T 95 Exclusiv	150	7800	
	T 98	150	8200	
	<b>Kündig</b>	Uniq, Basiq, Uniq S	150/200	2000
		ZBS 2, PBM 3	100	9000
ZBS 3		100	11200	
PBM 4		100	11000	
ZBS 4		100	13200	
GS 2 -6000		300	16300	
GS 2 - 9000		300	22300	
GS 2 - 12000		300	28300	
BKK 1/2, BKK 2		120	2240	
FF 1, UKF 1.1, FF 3.1		120	2300	
<b>Kuhlmeyer</b>	UKF 2	120	2500	
	KFS	150	2500	
	BS 75/-A/-W	100	950	
	HSF/HSDSF	100-200	500-5500	
	BS 200/-W	200	1500	
	BS 300/-W	300	2000	

Continuation →

# Short and long belts

Applications guide

## Portable sanding belt

Manufacturer	Type	Abrasive belt size		Manufacturer	Type	Dimensions in mm	
		Width in mm	Length in mm				
Löser	RPS 336, RP+S 377, SP 377, HSRG 377, ZSP 377	150	3500	AEG powertools	HBS 65, HBSE 65	65 × 410	
	RP+S 374	150	2500/3500		HBSE 600, HBS 1000 E	75 × 533	
	TP 80/TP 80S	30	740		RBSE 75 AE, RBSE 75 S	75 × 533	
	KS 100	5–100	3500/4000		HBS 100	100 × 560	
	KS 360	5–75	2500		HBSE 100	100 × 560	
	KS 350	5–75	3500/4000		BBS 1100	100 × 560	
	KS 363	6–50	2500		BBSE 1100	100 × 560	
	EB 2	50	2000		Atlas Copco	HBSE 75 S	75 × 533
	EB 3-S	max. 100	3500			HBSE 75	75 × 533
	FS 384/150-G1, SP 337, SP 374, HSD	150	2500			MBSE 705	75 × 533
	SP 352	150	3000			BBS 100	100 × 620
SP 380, RPS 376	150	3500	BBSE 100	100 × 620			
Löwer	KS 225	150	2250	Black & Decker		KA 290, KA 900 E	13 × 451
	KSM 1	150	2580		KA 292	13 × 451	
	KSM 2	150	2630		KA 293 E	13 × 451	
	SmartGrinder SG 150/300	150/300	3000		KA 83	65 × 410	
	LS 200, DSM 1000	200	1600		KA 83 E	65 × 410	
	DSM 2000, DSM 2004	200	1800		BS650	65 × 410	
	DSM 3000, DSM 3004, HBS 300, HBS 302, LS 300, Multi 300, HBS VR	300	1800		BD 83	65 × 410	
	HBS 400/HBS 400u/HBS 4000, Multi 400, HBS 4000 BB	400	1800		BD 83 E	65 × 410	
	Combi Queen	500	1800		DN83	65 × 410	
	Niederberger	P2/P5	50–200		2500	DN83E	65 × 410
P4		100–420	2500	KA 85 EK	75 × 457		
P6		320–420	2500	KA 85, KA 86	75 × 457		
Quick Wood	Elicoid	40	1780	P 61-03	75 × 508		
Scheppach	BGS 700	50	686	BD 75	75 × 508		
	CSM 405	77	2400	BD 85	75 × 508		
	BTS 900x	100	915	SR 500 E	75 × 508		
	ISE 600	150	1500	KA 75, KA 75 E, KA 88, XTA80EK	75 × 533		
	BSM 2010, KSM 2000	150	2000	Bosch	GVS 350 AE	40 × 303	
	KSM 2500	150	2515		PVS 300 AE	40 × 303	
	SLIK 7	150	2740		PBS 60	60 × 400	
SCM	TecnoMax UNILEV 150	150	2170		PBS 60 E	60 × 400	
	TecnoMax LS	150	7100		GBS 75 AE	75 × 533	
Stähle	Saturn E, Saturn Quattro	200	1800		PBS 75	75 × 533	
	Saturn Duo Comfort	200–320	1800		PBS 75 A	75 × 533	
Vobhag	ERS 25, EFS25, VFS 25	250	2500	PBS 75 AE	75 × 533		
	VFS 42, DSM 42	420	2500	PBS 75 E	75 × 533		
	DSM 46	460	2500	PBS 7 A, PBS 7 AE	75 × 457		
	VFS 52	520	2500	GBS 100 A	100 × 620		
	DSM 46/600	600	2500	GBS 100 AE	100 × 620		
Wegoma	KS2250/P	150	2250	DeWalt	D26480	64 × 356	
	KS2400	150	2400		MHB158	75 × 480	
	KS2600, KS2600FU	200	2600		MHB158 E	75 × 480	
			MHB 157		75 × 480		
			MHB 157 E		75 × 480		
			DW430, DW431		75 × 533		

Continuation →



# Short and long belts

Applications guide



Manufacturer	Type	Dimensions in mm
<b>DeWalt</b>	DW 432/ DW 433	75 × 533
	MHB90	100 × 560
	MHB90 E	100 × 560
	MHB90K	100 × 560
	DW650	100 × 560
	DW650E	100 × 560
<b>Einhell</b>	BBS 240, BBS 240/1	50 × 686
	BBS 720, BBS 850 E, BT-B5 850 E	75 × 457
	RT-B5 75, BT - BS 850/1 E	75 × 533
	BBS 1200	100 × 610
<b>Festool</b>	BF1	6/12/16/19 × 520
	BS 75, BS 75E, BS 75E-Set	75 × 533
	BS 105, BS 105E, BS 105E-Set	105 × 620
<b>Fein</b>	RS 12-70 E	20 × 815
	RS 10-70 E	30 × 533
<b>Felisatti</b>	TP 411, BSF 76/900	75 × 533, 76 × 533
	BSF 100/1200E	100 × 610
<b>Flex</b>	LBS 1105 VE	4/9/30 × 520/533
	LBS 1105 VE Set	4/9/30 × 520/533
	LBR 1506 VRA	40 × 618
	LRP 1503 VR	40 × 675
	LRP 1503 VRA	40/20 × 760
<b>Hitachi</b>	SB-75, SB8V2	75 × 533
	9924 DB	75 × 610
	SB 10 T, SB 10 V	100 × 610
	SB 10 V2, SB 10 S2	100 × 610
	SB 110	110 × 620
<b>HOLZ HER</b>	2405	65 × 410
	2406	65 × 410
	2410, 2411, 2420	75 × 533
	2422	105 × 620
	2423	105 × 620
<b>Kress</b>	2424	105 × 620
	CBS 6800 E	65 × 410
<b>Löser</b>	15003	3,6/13 × 305
	14000, 14021, 14021 F	3/6,5/13 × 610/863/1118
	40320	6/12 × 305/457
	11475, 11476, 11476 EL, 11486, 11486 EL	25 × 760
	11477, 11477 EL, 11450, 11450 EL	50 × 760
	14300, 14303	50 × 863
	14306	50 × 1143
	52900	75 × 610

Manufacturer	Type	Dimensions in mm
<b>Makita</b>	9032	9 × 533
	9031	30 × 533
	9910/9911	75 × 457
	9901	75 × 533
	9902/9903	75 × 533
	9900	75 × 533
	9924 DB	75 × 610
	9920	75 × 610
	9402	100 × 610
	9403	100 × 610
<b>Metabo</b>	9404	100 × 610
	9924 DB	100 × 610
	BFE 9-90 SET	6-19 × 457
	12-180 SET	40 × 760
	Ba 0775, BAE 75, Ba E 1075	75 × 533
<b>Milwaukee</b>	Ba E 0876 Signal	75 × 533
	Ba 6100	100 × 620
	HBSE 75 S	75 × 533
<b>Peugeot</b>	BS 100 LE	100 × 620
	PB 600	75 × 457
<b>Ryobi</b>	PAB 75	75 × 533
	B 850 F	75 × 533
	BE-321	75 × 533
	EBS 9576V, EBS 8021 V, EBS 800 V	75 × 533
	B-7075, B-7076, BE-7075	75 × 533
	B-7100	75 × 610
	B 422, BE 422, BE-1056	100 × 560
B-7200 A, BE-422, B/BE 424	100 × 610	
<b>SKIL</b>	BE-4240, EBS 1310 VF HG	100 × 610
	1100, 1200, 1205, 1200 H, 1205 H, 1210, 1210 AA 7600, 7610 AD, 7610 AA, 7620 AA, 7675, 1220 MA, 7630	75 × 457
	5903	75 × 508
	594 U, 595 U, 7640MA	75 × 533
	7650 AA, 7650 AE, 4640 MA	75 × 533
	1400	100 × 552
<b>Stayer</b>	7660 MA	100 × 610/620
	2 N 75	75 × 457
	LEN 751 E	75 × 533
	LEN 610	100 × 610
<b>Suhner</b>	LEN 690	100 × 690
	UBC 10-R	3/6/12/16/19 × 520
	UBK 6-R	35 × 450
	UTC 7-R	30 × 533
	UTG 9-R	30 × 610

# File belts

## Coated abrasives

Abrasive cloth

### LS 309 X



#### Properties

Bonding agent	Resin
Grain	Aluminium oxide
Coating	Close
Backing	X-cotton

#### Applications:

Metals	●
NF metals	●
Wood	●

**Advantages:** Universal belt for metalworking and woodworking - Excellent price-performance ratio

#### Available grits:

Width x Length in mm	Grit	Belt joint	Packing unit/pcs.	Cat. number
28 x 533	40	F4G	20	36755
28 x 533	60	F4G	20	37945
28 x 533	80	F4G	20	39236
28 x 533	100	F4G	20	40702
28 x 533	120	F4G	20	41900
28 x 533	150	F4G	20	42794

More file belts see belts

Abrasive cloth

### CS 310 XF



#### Properties

Bonding agent	Resin
Grain	Aluminium oxide
Coating	Close
Backing	XF-cotton

#### Applications:

Stainless steel	●
Metals	●
NF metals	●
Steel	●

**Advantages:** Universal type for working on radiuses and contours with belt files in all areas of metalworking

#### Available grits:

Width x Length in mm	Grit	Belt joint	Packing unit/pcs.	Cat. number
6 x 610	40	F4G	25	4644
6 x 610	60	F4G	25	4645
6 x 610	80	F4G	25	4646
6 x 610	120	F4G	25	70595
9 x 533	40	F4G	25	286879
9 x 533	60	F4G	25	156968
9 x 533	80	F4G	25	286880
9 x 533	120	F4G	25	286881
10 x 330	40	F4G	25	86104
10 x 330	60	F4G	25	71110
10 x 330	80	F4G	25	71111
10 x 330	100	F4G	25	71112

Other grits and sizes available on request.

Continuation →

Please observe: Minimum order quantities for manufactured items see page 41. Please see Applications Guide on page 38-45.

# File belts

Coated abrasives



→ Continuation of CS 310 XF, Abrasive cloth

Width x Length in mm	Grit	Belt joint	Packing unit/pcs.	Cat. number
10 x 330	120	F4G	25	71957
12 x 520	40	F4G	25	160139
12 x 520	60	F4G	25	160201
12 x 520	80	F4G	25	159040
12 x 520	120	F4G	25	160140
13 x 450	40	F4G	25	90914
13 x 450	60	F4G	25	75505
13 x 450	80	F4G	25	97081
13 x 450	120	F4G	25	105794
13 x 455	40	F4G	25	72895
13 x 455	60	F4G	25	73099
13 x 455	80	F4G	25	149565
13 x 455	100	F4G	25	73176
13 x 455	120	F4G	25	74086
13 x 610	40	F4G	25	4652
13 x 610	60	F4G	25	4653
13 x 610	80	F4G	25	4654
13 x 610	120	F4G	25	70591
13 x 610	240	F4G	25	99182
20 x 520	40	F4G	25	71959
20 x 520	60	F4G	25	71960
20 x 520	80	F4G	25	71961
20 x 520	120	F4G	25	71963
40 x 303	60	F4G	10	184719
40 x 303	80	F4G	10	188885

More file belts see belts

Abrasive cloth, waterproof

## CS 411 Y



### Properties

Bonding agent	Resin
Grain	Zirconia alumina
Coating	Close
Backing	Y-polyester

### Applications:

Stainless steel	●
Steel	●
Metals	●

**Advantages:** Tear-resistant product for use on belt files - Especially high aggressiveness and abrasive performance due to active abrasive substances - Especially for stainless steel, but also for steel and metal in general

Available grits:

16 24 30 36 40 50 60 80 100 120 150 180 220 240 280 320 360 400 500 600 800 1000 1200 1500 2000

Width x Length in mm	Grit	Belt joint	Packing unit/pcs.	Cat. number
9 x 533	40	F4G	25	286886
9 x 533	60	F4G	25	286887
9 x 533	80	F4G	25	286888
10 x 330	40	F4G	25	325250
10 x 330	60	F4G	25	302797

Other grits and sizes available on request.

Please observe: Minimum order quantities for manufactured items see page 41. Please see Applications Guide on page 38-45.

Continuation →

# File belts

## Coated abrasives

→ Continuation of CS 411 Y, Abrasive cloth, waterproof

Width x Length in mm	Grit	Belt joint	Packing unit/pcs.	Cat. number
10 x 330	80	F4G	25	302798
13 x 610	40	F4G	25	322530
13 x 610	60	F4G	25	302784
13 x 610	80	F4G	25	302785
20 x 520	36	F4G	25	322531
20 x 520	40	F4G	25	322532
20 x 520	60	F4G	25	302791
20 x 520	80	F4G	25	302792

More file belts see belts

Abrasive cloth

## CS 710 XF

**NEW**



### Properties

Bonding agent	Resin
Grain	Aluminium oxide
Coating	Close
Backing	XF-cotton

### Applications:

Steel	●
Stainless steel	●
NF metals	●



**Advantages:** Machine grinding of molded parts and weld seams in trade and industry - Flexible, yet tear-resistant backing - Abrasive belt with hardened and tempered aluminium oxide

Available grits:

16 24 30 36 40 50 60 80 100 120 150 180 220 240 280 320 360 400 500 600 800 1000 1200 1500 2000

Width x Length in mm	Grit	Belt joint	Packing unit/pcs.	Cat. number
9 x 533	80	F4G	25	342297
9 x 533	120	F4G	25	342296
10 x 330	80	F4G	25	342302
10 x 330	120	F4G	25	342303
13 x 455	80	F4G	25	342298
13 x 455	120	F4G	25	342299
13 x 610	80	F4G	25	342301
13 x 610	120	F4G	25	342300

More file belts see belts

Other grits and sizes available on request.

Please observe: Minimum order quantities for manufactured items see page 41. Please see Applications Guide on page 38-45.

Abrasive cloth, waterproof

## CS 912 Y ACT



### Properties

Bonding agent	Resin
Grain	Ceramic Al. oxide
Coating	Close
Backing	Y-polyester

### Applications:

Stainless steel	●
Steel	●

**Advantages:** Continuously aggressive abrasive performance, with long service life due to ceramic grit - High-performance abrasive belt for steel and stainless steel grinding

#### Available grits:

16 24 30 36 40 50 60 80 100 120 150 180 220 240 280 320 360 400 500 600 800 1000 1200 1500 2000

All sizes and minimum purchasing quantities available on request

More file belts see belts

Non-woven web belt

## NBF 800



### Properties

Bonding agent	Resin
Grain	Aluminium oxide

### Applications:

Stainless steel	●
NF metals	●
Metals	⊙

**Advantages:** Special product for surface finishing with hand tool belt grinders - Ideal for removal of discolorations, for light deburring, leveling, matt finishing and roughening - Minimal clogging and long service life - Suitable for dry and wet grinding

Width x Length in mm	Belt joint	Colour	Grade	Packing unit/pcs.	Cat. number
6 x 520	F4W	brown	coarse	10	258646
6 x 520	F4W	maroon	medium	10	258647
6 x 520	F4W	blue	very fine	10	258648
9 x 533	F4W	brown	coarse	10	258652
9 x 533	F4W	maroon	medium	10	258653
9 x 533	F4W	blue	very fine	10	258654
10 x 330	F4W	brown	coarse	10	258655
10 x 330	F4W	maroon	medium	10	258656
10 x 330	F4W	blue	very fine	10	258657
12 x 520	F4W	brown	coarse	10	258658
12 x 520	F4W	maroon	medium	10	258659
12 x 520	F4W	blue	very fine	10	258660
12 x 533	F4W	brown	coarse	10	258661
12 x 533	F4W	maroon	medium	10	258662
12 x 533	F4W	blue	very fine	10	258663
13 x 457	F4W	brown	coarse	10	258664
13 x 457	F4W	maroon	medium	10	258665
13 x 457	F4W	blue	very fine	10	258666

Other grits and sizes available on request.

Continuation →

Please observe: Minimum order quantities for manufactured items see page 41. Please see Applications Guide on page 38-45.



# File belts

→ Continuation of NBF 800, Non-woven web belt

Width x Length in mm	Belt joint	Colour	Grade	Packing unit/pcs.	Cat. number
13 x 610	F4W	brown	coarse	10	258667
13 x 610	F4W	maroon	medium	10	258668
13 x 610	F4W	blue	very fine	10	258669
20 x 520	F4W	brown	coarse	10	258671
20 x 520	F4W	maroon	medium	10	258672
20 x 520	F4W	blue	very fine	10	258673
28 x 533	F4W	brown	coarse	10	258674
28 x 533	F4W	maroon	medium	10	258695
28 x 533	F4W	blue	very fine	10	258696
30 x 533	F4W	brown	coarse	5	258699
30 x 533	F4W	maroon	medium	5	258700
30 x 533	F4W	blue	very fine	5	258701
30 x 610	F4W	maroon	medium	5	258703
30 x 610	F4W	blue	very fine	5	258704

Information regarding grit range see chart on page 75.

Other grades and sizes available on request.

Please observe: Minimum order quantities for manufactured items see page 41. Please see Applications Guide on page 38-45.

# Short belts for hand held machines

Coated abrasives



Abrasive cloth

## LS 309 XH

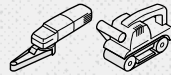

### Properties

Bonding agent	Resin
Grain	Aluminium oxide
Coating	Close
Backing	X-cotton

### Applications:

Wood	●
Metals	●
NF metals	●
Paint/Varnish/Filler	⦿

**Advantages:** Special type for portable belt sanders - For universal use on wood, metal, paint and varnish - Large product mix of belts for all standard machines

### Available grits:

16	24	30	36	40	50	60	80	100	120	150	180	220	240	280	320	360	400	500	600	800	1000	1200	1500	2000
----	----	----	----	----	----	----	----	-----	-----	-----	-----	-----	-----	-----	-----	-----	-----	-----	-----	-----	------	------	------	------

Width x Length in mm	Grit	Belt joint	Packing unit/pcs.	Cat. number
60 x 400	60	F5	10	4100
60 x 400	80	F5	10	4104
60 x 400	120	F5	10	4097
65 x 410	40	F5	10	4106
65 x 410	60	F5	10	4114
65 x 410	80	F5	10	4120
65 x 410	100	F5	10	4124
65 x 410	120	F5	10	4128
75 x 457	40	F5	10	37269
75 x 457	60	F5	10	38825
75 x 457	80	F5	10	40345
75 x 457	100	F5	10	41560
75 x 457	120	F5	10	42627
75 x 457	150	F5	10	43020
75 x 480	40	F5	10	4098
75 x 480	60	F5	10	4107
75 x 480	80	F5	10	4115
75 x 480	100	F5	10	4121
75 x 480	120	F5	10	4125
75 x 508	40	F5	10	4099
75 x 508	60	F5	10	4103
75 x 508	80	F5	10	4117
75 x 508	100	F5	10	4118
75 x 533	40	F5	10	4137
75 x 533	60	F5	10	4139
75 x 533	80	F5	10	4140
75 x 533	100	F5	10	4141
75 x 533	120	F5	10	4142
75 x 533	150	F5	10	4143
75 x 533	180	F5	10	4144
75 x 533	240	F5	10	43614
75 x 610	40	F5	10	37285
75 x 610	60	F5	10	38842
75 x 610	80	F5	10	40365

Other grits and sizes available on request.

Continuation →

Please observe: Minimum order quantities for manufactured items see page 41. Please see Applications Guide on page 38-45.

# Short belts for hand held machines

## Coated abrasives

→ Continuation of LS 309 XH, Abrasive cloth

Width x Length in mm	Grit	Belt joint	Packing unit/pcs.	Cat. number
75 x 610	100	F5	10	41576
75 x 610	120	F5	10	42642
100 x 560	40	F5	10	4151
100 x 560	60	F5	10	4473
100 x 560	80	F5	10	4474
100 x 560	100	F5	10	4475
100 x 560	120	F5	10	4476
100 x 560	150	F5	10	4477
100 x 610	40	F5	10	4478
100 x 610	60	F5	10	4480
100 x 610	80	F5	10	4481
100 x 610	100	F5	10	4482
100 x 610	120	F5	10	4483
100 x 610	150	F5	10	4484
100 x 610	180	F5	10	43302
100 x 620	40	F5	10	6272
100 x 620	60	F5	10	6278
100 x 620	80	F5	10	6283
100 x 620	100	F5	10	6284
100 x 620	120	F5	10	6286
100 x 620	150	F5	10	6288
105 x 620	40	F5	10	4485
105 x 620	60	F5	10	4487
105 x 620	80	F5	10	4489
105 x 620	100	F5	10	4490
105 x 620	120	F5	10	4491
105 x 620	150	F5	10	4492
110 x 620	40	F5	10	6290
110 x 620	60	F5	10	6292
110 x 620	80	F5	10	6294
110 x 620	100	F5	10	6295
110 x 620	120	F5	10	6296

More short belts for hand held machines see belts

Other grits and sizes available on request.

Please observe: Minimum order quantities for manufactured items see page 41. Please see Applications Guide on page 38-45.

# Belts with paper backing

Coated abrasives



Abrasive paper

## PS 20 F



### Properties

Bonding agent	Resin
Grain	Aluminium oxide
Coating	Close
Backing	F-paper

### Applications:

Metals	●
NF metals	●
Stainless steel	●
Steel	⓪

**Advantages:** Universal type for finish grinding of steel, stainless steel and other metals - High stock removal rate

Available grits:

16 24 30 36 40 50 60 80 100 120 150 180 220 240 280 320 360 400 500 600 800 1000 1200 1500 2000

All sizes and minimum purchasing quantities available on request

Abrasive paper

## PS 21 F



### Properties

Bonding agent	Resin
Grain	Zirconia alumin./ Al. oxide
Coating	Close
Backing	F-paper

### Applications:

Stainless steel	●
Metals	●
Steel	●

**Advantages:** High aggressiveness and long service life due to self-sharpening zirconia alumina - Specially developed for rough grinding through finish grinding of stainless steel surfaces

Available grits:

16 24 30 36 40 50 60 80 100 120 150 180 220 240 280 320 360 400 500 600 800 1000 1200 1500 2000

All sizes and minimum purchasing quantities available on request

Abrasive paper, ANTISTATIC

## PS 22 F ACT

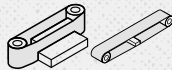

### Properties

Bonding agent	Resin
Grain	Aluminium oxide
Coating	Close
Backing	F-paper

### Applications:

Wood	●	Plastic	⓪
Metals	⓪		
NF metals	⓪		
Paint/Varnish/Filler	⓪		

**Advantages:** High removal rate, fine surface scratch pattern - Specially developed for finish grinding of hardwood - Reduced clogging and longer service life due to ACT recipe and antistatic properties

Available grits:

16 24 30 36 40 50 60 80 100 120 150 180 220 240 280 320 360 400 500 600 800 1000 1200 1500 2000

All sizes and minimum purchasing quantities available on request

Other grits and sizes available on request.

Please observe: Minimum order quantities for manufactured items see page 41. Please see Applications Guide on page 38-45.

# Belts with paper backing

Coated abrasives

Abrasive paper, ANTISTATIC

## PS 24 F ACT

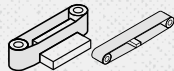

### Properties

Bonding agent	Resin
Grain	SiC
Coating	Close
Backing	F-paper

### Applications:

Paint/Varnish/Filler	●
Plastic	●
Wood	◐

**Advantages:** For hard and tough surfaces - Finely sanded and varnish surfaces in the wood and furniture industry - Long service life due to ACT recipe and antistatic properties

### Available grits:

16 24 30 36 40 50 60 80 100 120 150 180 220 240 280 320 360 400 500 600 800 1000 1200 1500 2000

All sizes and minimum purchasing quantities available on request

Abrasive paper, ANTISTATIC

## PS 27 DW



### Properties

Bonding agent	Resin
Grain	SiC
Coating	Open
Backing	D-paper

### Applications:

Paint/Varnish/Filler	●
Aluminium	●
Plastic	◐

**Advantages:** Special product for high-quality varnish surfaces, especially UV finishes - Substantially reduced clogging and longer service life due to additional special coating - Very fine surface scratch pattern

### Available grits:

16 24 30 36 40 50 60 80 100 120 150 180 220 240 280 320 360 400 500 600 800 1000 1200 1500 2000

All sizes and minimum purchasing quantities available on request

Abrasive paper, ANTISTATIC

## PS 28 F

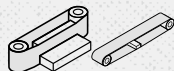

### Properties

Bonding agent	Resin
Grain	Aluminium oxide
Coating	Open
Backing	F-paper

### Applications:

Wood	●
------	---

**Advantages:** Universal belt for general woodworking, especially softwood - Excellent price-performance ratio

### Available grits:

16 24 30 36 40 50 60 80 100 120 150 180 220 240 280 320 360 400 500 600 800 1000 1200 1500 2000

All sizes and minimum purchasing quantities available on request

Other grits and sizes available on request.

Please observe: Minimum order quantities for manufactured items see page 41. Please see Applications Guide on page 38-45.



# Belts with paper backing

Coated abrasives



Abrasive paper, ANTISTATIC

## PS 29 F ACT

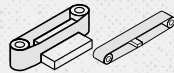

### Properties

Bonding agent	Resin
Grain	Aluminium oxide
Coating	Open
Backing	F-paper

### Applications:

Wood	●
------	---

**Advantages:** High-quality universal belt for general woodworking, especially softwood - Reduced clogging and longer service life due to ACT recipe and antistatic properties

### Available grits:

Width x Length in mm	Grit	Belt joint	Packing unit/pcs.	Cat. number
150 x 2000	80	F5	10	307797
150 x 2000	100	F5	10	307798
150 x 2000	120	F5	10	307799
150 x 2170	80	F5	10	307800
150 x 2170	120	F5	10	307801
150 x 2250	60	F5	10	307802
150 x 2250	80	F5	10	307803
150 x 2250	100	F5	10	307804
150 x 2250	120	F5	10	307805
150 x 2250	150	F5	10	307806
150 x 2280	80	F5	10	307807
150 x 2280	100	F5	10	307808
150 x 2280	120	F5	10	307809
150 x 2600	80	F5	10	307811
150 x 2600	100	F5	10	307812
150 x 2600	120	F5	10	307813
150 x 3000	80	F5	10	307814
150 x 3000	100	F5	10	307815
150 x 3000	120	F5	10	307816
150 x 6800	80	F2	10	307821
150 x 6800	100	F2	10	307822
150 x 6800	120	F2	10	307823
150 x 6880	80	F2	10	307824
150 x 6880	100	F2	10	307825
150 x 6880	120	F2	10	307826
150 x 7100	60	F2	10	307828
150 x 7100	80	F2	10	307829
150 x 7100	100	F2	10	307830
150 x 7100	120	F2	10	307831
150 x 7100	150	F2	10	307832
150 x 7200	80	F2	10	307833
150 x 7200	100	F2	10	307834
150 x 7200	120	F2	10	307835
150 x 7500	80	F2	10	307837
150 x 7500	100	F2	10	307838
150 x 7500	120	F2	10	307839
150 x 7800	80	F2	10	307840

Other grits and sizes available on request.

Continuation →

Please observe: Minimum order quantities for manufactured items see page 41. Please see Applications Guide on page 38-45.

# Belts with paper backing

Coated abrasives

→ Continuation of PS 29 F ACT, Abrasive paper, ANTISTATIC

Width x Length in mm	Grit	Belt joint	Packing unit/pcs.	Cat. number
150 x 7800	100	F2	10	307841
150 x 7800	120	F2	10	307842
150 x 7800	150	F2	10	307843
200 x 1600	80	F5	10	307844
200 x 1600	100	F5	10	307845
200 x 1600	120	F5	10	307846
200 x 3000	80	F5	10	307847
200 x 3000	100	F5	10	307848
200 x 3000	120	F5	10	307849
200 x 3000	150	F5	10	307850

Abrasive paper

## PS 61 F



### Properties

Bonding agent	Resin
Grain	Ceramic Al. oxide
Coating	Close
Backing	F-paper

### Applications:

Stainless steel	●
Steel	●
Wood	○

**Advantages:** Continuously aggressive abrasive behaviour due to micro-crystalline and self-sharpening ceramic grit - High-performance abrasive belt for stainless steel finish grinding

Available grits:

16 24 30 36 40 50 60 80 100 120 150 180 220 240 280 320 360 400 500 600 800 1000 1200 1500 2000

All sizes and minimum purchasing quantities available on request

Abrasive paper, KULEX

## PS 729 F

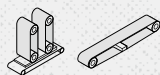

### Properties

Bonding agent	Resin
Grain	Al. oxide agglom.
Backing	F-paper

### Applications:

Stainless steel	●
Steel	●

**Advantages:** Long life belt for dry grinding applications - Extremely high service life - Constant surface quality for pre-grinding until finishing - Especially developed for grinding with intermediate contact pressure

Available grits:

16 24 30 36 40 50 60 80 100 120 150 180 220 240 280 320 360 400 500 600 800 1000 1200 1500 2000

All sizes and minimum purchasing quantities available on request

Other grits and sizes available on request.

Please observe: Minimum order quantities for manufactured items see page 41. Please see Applications Guide on page 38-45.

# Belts with film backing

Coated abrasives



Abrasive film, active coated

## FP 73 W



### Properties

Bonding agent	Resin
Grain	Aluminium oxide
Coating	Semi-open
Backing	Film

### Applications:

Paint/Varnish/Filler	●
Plastic	●

**Advantages:** Special product for processing varnish, plastic and composites - Highly tear-resistant film backing - Abrasive belt with extremely good adaptation, smooth surface and excellent grit adhesion - Substantially reduced clogging and significantly longer service life

### Available grits:

16 24 30 36 40 50 60 80 100 120 150 180 220 240 280 320 360 400 500 600 800 1000 1200 1500 2000

All sizes and minimum purchasing quantities available on request

Other grits and sizes available on request.

Please observe: Minimum order quantities for manufactured items see page 41. Please see Applications Guide on page 38-45.

# Belts with cloth backing

Coated abrasives

Abrasive cloth

## CS 308 Y

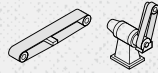

### Properties

Bonding agent	Resin
Grain	Aluminium oxide
Coating	Close
Backing	Y-polyester

### Applications:

Stainless steel	●	Plastic	○
Wood	●		
Steel	●		
NF metals	●		

**Advantages:** Tear-resistant universal abrasive cloth for metalworking and for hardwood finish grinding - Excellent removal rate under high stress

### Available grits:

16 24 30 36 40 50 60 80 100 120 150 180 220 240 280 320 360 400 500 600 800 1000 1200 1500 2000

All sizes and minimum purchasing quantities available on request

Abrasive cloth

## LS 309 X

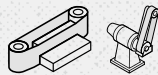

### Properties

Bonding agent	Resin
Grain	Aluminium oxide
Coating	Close
Backing	X-cotton

### Applications:

Metals	●
NF metals	●
Wood	●

**Advantages:** Universal belt for metalworking and woodworking - Excellent price-performance ratio

### Available grits:

16 24 30 36 40 50 60 80 100 120 150 180 220 240 280 320 360 400 500 600 800 1000 1200 1500 2000

Width x Length in mm	Grit	Belt joint	Packing unit/pcs.	Cat. number
50 x 1020	40	F5	10	36837
50 x 1020	60	F5	25	38075
50 x 1020	80	F5	25	39401
50 x 1020	100	F5	25	40832
50 x 1020	120	F5	25	42020
50 x 2000	40	F4G	10	4502
50 x 2000	60	F4G	25	4531
50 x 2000	80	F4G	25	4548
75 x 2000	40	F4G	10	36923
75 x 2000	60	F4G	10	38198
75 x 2000	80	F4G	10	39556
100 x 800	60	F5	10	38286
100 x 800	80	F5	10	39659
100 x 800	120	F5	10	137024
100 x 860	60	F5	10	38895
100 x 860	80	F5	10	40425
100 x 860	100	F5	10	41621
100 x 860	120	F5	10	42678

Other grits and sizes available on request.

Continuation →

Please observe: Minimum order quantities for manufactured items see page 41. Please see Applications Guide on page 38-45.

# Belts with cloth backing

Coated abrasives



→ Continuation of LS 309 X, Abrasive cloth

Width x Length in mm	Grit	Belt joint	Packing unit/pcs.	Cat. number
100 x 900	60	F5	10	38898
100 x 900	80	F5	10	40428
100 x 900	100	F5	10	41623
100 x 900	120	F5	10	42679
100 x 915	40	F5	10	37324
100 x 915	60	F5	10	38900
100 x 915	80	F5	10	40430
100 x 915	100	F5	10	41625
100 x 915	120	F5	10	42681
100 x 915	150	F5	10	43054
100 x 915	180	F5	10	43308
100 x 915	240	F5	10	128755
100 x 950	40	F5	10	37328
100 x 950	60	F5	10	38904
100 x 950	80	F5	10	40435
100 x 950	100	F5	10	41627
100 x 950	120	F5	10	42684
100 x 1000	40	F5	10	36999
100 x 1000	60	F5	10	38304
100 x 1000	80	F5	10	39679
100 x 1000	100	F5	10	41019
100 x 1000	120	F5	10	42199
150 x 1220	60	F5	10	38428
150 x 1220	80	F5	10	39852
150 x 2000	40	F4G	10	37071
150 x 2000	60	F4G	10	38460
150 x 2000	80	F4G	10	39884

Abrasive cloth

## LS 309 J

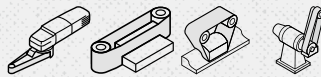

### Properties

Bonding agent	Resin
Grain	Aluminium oxide
Coating	Close
Backing	J-cotton

### Applications:

Metals	●
NF metals	●
Wood	●

**Advantages:** Good abrasive performance for working on slight contours on metal and wood

### Available grits:

16	24	30	36	40	50	60	80	100	120	150	180	220	240	280	320	360	400	500	600	800	1000	1200	1500	2000
----	----	----	----	----	----	----	----	-----	-----	-----	-----	-----	-----	-----	-----	-----	-----	-----	-----	-----	------	------	------	------

All sizes and minimum purchasing quantities available on request

Other grits and sizes available on request.

Please observe: Minimum order quantities for manufactured items see page 41. Please see Applications Guide on page 38-45.



# Belts with cloth backing

Coated abrasives

Abrasive cloth

## LS 309 JF

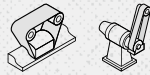

### Properties

Bonding agent	Resin
Grain	Aluminium oxide
Coating	Close
Backing	JF-cotton

### Applications:

Metals	●
NF metals	●
Wood	●

**Advantages:** High removal rate in metalworking and woodworking - Very good adaptation to radiuses and contours due to highly flexible cotton backing

### Available grits:

16 24 30 36 40 50 60 80 100 120 150 180 220 240 280 320 360 400 500 600 800 1000 1200 1500 2000

All sizes and minimum purchasing quantities available on request

Abrasive cloth

## CS 310 X

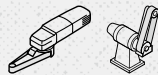

### Properties

Bonding agent	Resin
Grain	Aluminium oxide
Coating	Close
Backing	X-cotton

### Applications:

Stainless steel	●	Plastic	○
Wood	●		
Steel	●		
NF metals	●		

**Advantages:** High-quality universal type for metalworking and woodworking - Good removal rate under high stress

### Available grits:

16 20 24 30 36 40 50 60 80 100 120 150 180 220 240 280 320 360 400 500 600 800 1000 1200 1500 2000

Width x Length in mm	Grit	Belt joint	Packing unit/pcs.	Cat. number
25 x 1065	60	F4G	10	244635
25 x 1065	80	F4G	10	244634
50 x 1020	40	F5	10	47753
50 x 1020	60	F5	25	48549
50 x 1020	80	F5	25	49300
50 x 2000	40	F4G	10	4587
50 x 2000	60	F4G	25	4590
50 x 2000	80	F4G	25	4591
50 x 2000	120	F4G	25	4593
75 x 2000	36	F4G	10	4594
75 x 2000	40	F4G	10	4595
75 x 2000	60	F4G	25	4596
75 x 2000	80	F4G	25	49399
75 x 2000	120	F4G	25	50652
75 x 2000	180	F4G	25	51222
75 x 2000	240	F4G	25	51470
100 x 920	60	F5	10	48717
100 x 920	80	F5	10	49454

Other grits and sizes available on request.

Continuation →

Please observe: Minimum order quantities for manufactured items see page 41. Please see Applications Guide on page 38-45.

# Belts with cloth backing

Coated abrasives



→ Continuation of CS 310 X, Abrasive cloth

Width x Length in mm	Grit	Belt joint	Packing unit/pcs.	Cat. number
100 x 920	100	F5	10	50136
150 x 2000	36	F4G	10	47492
150 x 2000	40	F4G	10	47921
150 x 2000	60	F4G	10	48821
150 x 2000	80	F4G	10	49581
150 x 2000	120	F4G	10	50767
200 x 550	24	F7G	10	170543
200 x 550	40	F7G	10	97832
200 x 550	60	F7G	10	105992
200 x 550	80	F7G	10	123929
200 x 550	120	F7G	10	123931
200 x 750	24	F7G	10	47101
200 x 750	36	F7G	10	47561
200 x 750	40	F7G	10	48028
200 x 750	60	F7G	10	48970
200 x 750	80	F7G	10	49764
200 x 750	100	F7G	10	50340
200 x 750	120	F7G	10	50872

Abrasive cloth ANTISTATIC

## CS 311 Y ACT

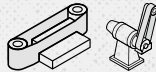

### Properties

Bonding agent	Resin
Grain	Aluminium oxide
Coating	Open
Backing	Y-polyester

### Applications:

Wood	●
Metals	⓪

**Advantages:** Good removal rate for working on wood under high stress - Minimal clogging and long service life due to ACT recipe and antistatic properties

Available grits:

16 24 30 36 40 50 60 80 100 120 150 180 220 240 280 320 360 400 500 600 800 1000 1200 1500 2000

All sizes and minimum purchasing quantities available on request

Other grits and sizes available on request.

Please observe: Minimum order quantities for manufactured items see page 41. Please see Applications Guide on page 38-45.

# Belts with cloth backing

Coated abrasives

Abrasive cloth

## LS 312 JF

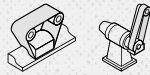

### Properties

Bonding agent	Resin
Grain	Aluminium oxide
Coating	Close
Backing	JF-cotton

### Applications:

Stainless steel	●	Wood	●
Metals	●		
NF metals	●		
Steel	●		

**Advantages:** Outstanding removal rate and service life due to active abrasive substances - Very good adaptation to radiuses and contours due to highly flexible cotton backing

### Available grits:

Width x Length in mm	Grit	Belt joint	Packing unit/pcs.	Cat. number
300 x 3500	100	F1	10	79849
300 x 3500	150	F1	10	247873
300 x 3500	180	F1	10	81518
300 x 3500	280	F1	10	79850
300 x 3500	320	F1	10	83657
300 x 3500	400	F1	10	81147

Abrasive cloth, multibond

## LS 313 JF

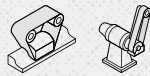

### Properties

Bonding agent	Resin
Grain	Aluminium oxide
Coating	Close
Backing	JF-cotton

### Applications:

Stainless steel	●
Aluminium	●
NF metals	●

**Advantages:** Top product for working on temperature-sensitive molded parts - Very good adaptation to radiuses and contours due to highly flexible cotton backing - Cool grinding due to additional multibond

### Available grits:

16	24	30	36	40	50	60	80	100	120	150	180	220	240	280	320	360	400	500	600	800	1000	1200	1500	2000
----	----	----	----	----	----	----	----	-----	-----	-----	-----	-----	-----	-----	-----	-----	-----	-----	-----	-----	------	------	------	------

All sizes and minimum purchasing quantities available on request

Other grits and sizes available on request.

Please observe: Minimum order quantities for manufactured items see page 41. Please see Applications Guide on page 38-45.

# Belts with cloth backing

Coated abrasives



Abrasive cloth

## LS 314 JF



**NEW**

### Properties

Bonding agent	Resin
Grain	Aluminium oxide
Coating	Close
Backing	JF-cotton

### Applications:

Metals	●
Plastic	●
NF metals	●

**Advantages:** Specialized product with stearate coating to reduce clogging during work on lightly and heavily profiled parts made of brass, aluminum and composite materials (plastic/stainless steel or wood/stainless steel)

Available grits:

16 24 30 36 40 50 60 80 100 120 150 180 220 240 280 320 360 400 500 600 800 1000 1200 1500 2000

All sizes and minimum purchasing quantities available on request

Abrasive cloth ANTISTATIC, SUPERFLEX

## LS 318 JF ACT



### Properties

Bonding agent	Resin
Grain	Aluminium oxide
Coating	Open
Backing	JF-cotton

### Applications:

Wood	●
------	---

**Advantages:** Top product for working on profiles and contours, especially in woodworking - Outstanding adaptation, also to tight radiuses, due to highly flexible cotton backing - Reduced clogging and long service life due to the ACT recipe

Available grits:

16 24 30 36 40 50 60 80 100 120 150 180 220 240 280 320 360 400 500 600 800 1000 1200 1500 2000

All sizes and minimum purchasing quantities available on request

Abrasive cloth, waterproof

## CS 320 Y



### Properties

Bonding agent	Resin
Grain	SiC
Coating	Close
Backing	Y-polyester

### Applications:

Glass/Stone	●
Mineral based materials	●
Plastic	●

**Advantages:** Outstanding abrasive performance on hard and difficult-to-machine materials - Ideal for high stress - Can be used wet or dry

Available grits:

16 24 30 36 40 50 60 80 100 120 150 180 220 240 280 320 360 400 500 600 800 1000 1200 1500 2000

All sizes and minimum purchasing quantities available on request

Other grits and sizes available on request.

Please observe: Minimum order quantities for manufactured items see page 41. Please see Applications Guide on page 38-45.

# Belts with cloth backing

Coated abrasives

Abrasive cloth, waterproof

## CS 321 X

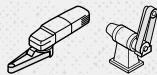

### Properties

Bonding agent	Resin
Grain	SiC
Coating	Close
Backing	X-cotton

### Applications:

Glass/Stone	●
Mineral based materials	●
Plastic	●

**Advantages:** Outstanding abrasive performance on hard and difficult-to-machine materials - Ideal for wet grinding, but also suitable for dry grinding

Available grits:

16 24 30 36 40 50 60 80 100 120 150 180 220 240 280 320 360 400 500 600 800 1000 1200 1500 2000

All sizes and minimum purchasing quantities available on request

Abrasive cloth, waterproof

## CS 322 X

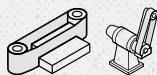

### Properties

Bonding agent	Resin
Grain	Cork
Backing	X-cotton

### Applications:

Glass/Stone	●
-------------	---

**Advantages:** Special product for polishing glass with high quality cork/resin coating - Long life with consistent polishing effect - Waterproof

All sizes and minimum purchasing quantities available on request

Abrasive cloth, KULEX

## CS 325 Y

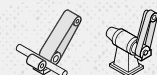

### Properties

Bonding agent	Resin
Grain	SiC agglom.
Backing	Y-polyester

### Applications:

Stainless steel	●
Glass/Stone	●
Metals	●

**Advantages:** Long-life abrasive belt for a brilliant, glossy finish, under medium to high grinding pressure - Extremely long life, with consistent surface roughness and finish - Suitable for dry and wet grinding

Available grits:

16 24 30 36 40 50 60 80 100 120 150 180 220 240 280 320 360 400 500 600 800 1000 1200 1500 2000

All sizes and minimum purchasing quantities available on request

Other grits and sizes available on request.

Please observe: Minimum order quantities for manufactured items see page 41. Please see Applications Guide on page 38-45.



# Belts with cloth backing

Coated abrasives



Abrasive cloth, KULEX

## CS 326 Y

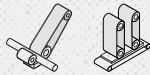

Properties	
Bonding agent	Resin
Grain	Al. oxide agglom.
Backing	Y-polyester

Applications:	
Stainless steel	●
Steel	●

**Advantages:** Long-life abrasive belt for a satin surface scratch pattern, under medium to high grinding pressure - Extremely long life, with consistent surface roughness and finish - Suitable for dry grinding

Available grits:

16 24 30 36 40 50 60 80 100 120 150 180 220 240 280 320 360 400 500 600 800 1000 1200 1500 2000

All sizes and minimum purchasing quantities available on request

Abrasive cloth, KULEX

## CS 329 JF

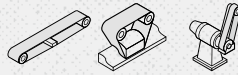

Properties	
Bonding agent	Resin
Grain	Al. oxide agglom.
Backing	JF-cotton

Applications:	
Stainless steel	●
Steel	●

**Advantages:** Long-life abrasive belt for a satin surface scratch pattern, under low to medium grinding pressure - Very suitable for strongly profiled workpieces - Especially suitable for dry grinding

Available grits:

16 24 30 36 40 50 60 80 100 120 150 180 220 240 280 320 360 400 500 600 800 1000 1200 1500 2000

All sizes and minimum purchasing quantities available on request

Abrasive cloth, KULEX

## CS 329 Y

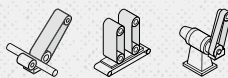

Properties	
Bonding agent	Resin
Grain	Al. oxide agglom.
Backing	Y-polyester

Applications:	
Stainless steel	●
Steel	●

**Advantages:** Long-life abrasive belt for a satin surface scratch pattern, under low to medium grinding pressure - Especially suitable for dry grinding

Available grits:

16 24 30 36 40 50 60 80 100 120 150 180 220 240 280 320 360 400 500 600 800 1000 1200 1500 2000

All sizes and minimum purchasing quantities available on request

Other grits and sizes available on request.

Please observe: Minimum order quantities for manufactured items see page 41. Please see Applications Guide on page 38-45.



# Belts with cloth backing

Coated abrasives

Abrasive cloth, waterproof

## CS 330 X

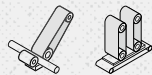

### Properties

Bonding agent	Resin
Grain	SiC/Cork
Coating	Close
Backing	X-cotton

### Applications:

Stainless steel	●
Steel	●

**Advantages:** Soft, very fine grinding with low surface roughness, polishable - Special belt for satin final finishing of stainless steel and steel surfaces with cork granulate with SiC/resin coating

Available grits:

16	24	30	36	40	50	60	80	100	120	150	180	220	240	280	320	360	400	500	600	800	1000	1200	1500	2000
----	----	----	----	----	----	----	----	-----	-----	-----	-----	-----	-----	-----	-----	-----	-----	-----	-----	-----	------	------	------	------

All sizes and minimum purchasing quantities available on request

Abrasive cloth

## CS 333 X

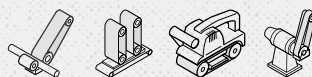

### Properties

Bonding agent	Resin
Grain	SiC
Coating	Close
Backing	X-cotton

### Applications:

Glass/Stone	●
Plastic	●
Metals	●

**Advantages:** Ideal for dry grinding of very hard or difficult-to-machine materials (castings, scales, ceramic, rubber, plastic)

Available grits:

16	24	30	36	40	50	60	80	100	120	150	180	220	240	280	320	360	400	500	600	800	1000	1200	1500	2000
----	----	----	----	----	----	----	----	-----	-----	-----	-----	-----	-----	-----	-----	-----	-----	-----	-----	-----	------	------	------	------

All sizes and minimum purchasing quantities available on request

Abrasive cloth

## CS 333 XF

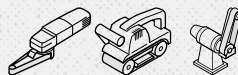

### Properties

Bonding agent	Resin
Grain	SiC
Coating	Close
Backing	XF-cotton

### Applications:

Metals	●
NF metals	●
Plastic	●

**Advantages:** Long service life and high abrasive performance - Top product for robot grinding of brass fittings - Optimal combination of flexibility and tear resistance

Available grits:

16	24	30	36	40	50	60	80	100	120	150	180	220	240	280	320	360	400	500	600	800	1000	1200	1500	2000
----	----	----	----	----	----	----	----	-----	-----	-----	-----	-----	-----	-----	-----	-----	-----	-----	-----	-----	------	------	------	------

All sizes and minimum purchasing quantities available on request

Other grits and sizes available on request.

Please observe: Minimum order quantities for manufactured items see page 41. Please see Applications Guide on page 38-45.

# Belts with cloth backing

Coated abrasives



Abrasive cloth

## CS 333 JF

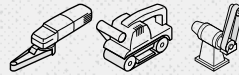

### Properties

Bonding agent	Resin
Grain	SiC
Coating	Close
Backing	JF-cotton

### Applications:

NF metals	●
Metals	●
Plastic	●

**Advantages:** Long service life and high abrasive performance - Very good adaptation to radiuses and contours due to highly flexible cotton backing - Ideal for hand grinding of brass fittings and other molded parts

Available grits:

16 24 30 36 40 50 60 80 100 120 150 180 220 240 280 320 360 400 500 600 800 1000 1200 1500 2000

All sizes and minimum purchasing quantities available on request

Abrasive cloth, waterproof

## CS 341 X

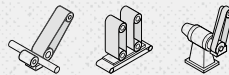

### Properties

Bonding agent	Resin
Grain	Aluminium oxide
Coating	Close
Backing	X-cotton

### Applications:

Metals	●
Stainless steel	●
Steel	●
NF metals	●

**Advantages:** High-quality universal type for wet grinding - Good service life and fine finish - Especially for rough through fine grinding in centreless and surface grinding applications

Available grits:

16 24 30 36 40 50 60 80 100 120 150 180 220 240 280 320 360 400 500 600 800 1000 1200 1500 2000

All sizes and minimum purchasing quantities available on request

Abrasive cloth, multibond

## CS 409 Y

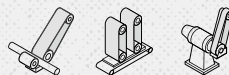

### Properties

Bonding agent	Resin
Grain	Zirconia alumina
Coating	Close
Backing	Y-polyester

### Applications:

Stainless steel	●
NF metals	○

**Advantages:** Aggressive abrasive behaviour - Cool grinding and increased grinding performance on stainless steel and high-alloy steels due to additional multibond - Very long service life also when used for grinding of non-ferrous metals

Available grits:

16 24 30 36 40 50 60 80 100 120 150 180 220 240 280 320 360 400 500 600 800 1000 1200 1500 2000

All sizes and minimum purchasing quantities available on request

Other grits and sizes available on request.

Please observe: Minimum order quantities for manufactured items see page 41. Please see Applications Guide on page 38-45.

# Belts with cloth backing

Coated abrasives

Abrasive cloth, multibond

## CS 410 X

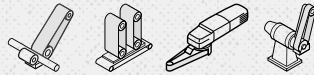

### Properties

Bonding agent	Resin
Grain	Aluminium oxide
Coating	Close
Backing	X-cotton

### Applications:

Stainless steel	●
NF metals	●

**Advantages:** Cool grinding and no heat tinting due to additional multibond - Increased abrasive performance for use on stainless steel

### Available grits:

16	24	30	36	40	50	60	80	100	120	150	180	220	240	280	320	360	400	500	600	800	1000	1200	1500	2000
----	----	----	----	----	----	----	----	-----	-----	-----	-----	-----	-----	-----	-----	-----	-----	-----	-----	-----	------	------	------	------

Width x Length in mm	Grit	Belt joint	Packing unit/pcs.	Cat. number
50 x 450	60	F4G	25	53108
50 x 450	80	F4G	25	53267
50 x 450	120	F4G	25	53538

Abrasive cloth

## CS 411 X

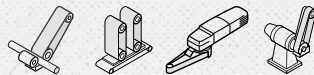

### Properties

Bonding agent	Resin
Grain	Zirconia alumina
Coating	Close
Backing	X-cotton

### Applications:

Stainless steel	●
Steel	●
Metals	●

**Advantages:** High aggressiveness and abrasive performance in rough grinding of steel and stainless steel - Very versatile in all areas of metalworking

### Available grits:

16	24	30	36	40	50	60	80	100	120	150	180	220	240	280	320	360	400	500	600	800	1000	1200	1500	2000
----	----	----	----	----	----	----	----	-----	-----	-----	-----	-----	-----	-----	-----	-----	-----	-----	-----	-----	------	------	------	------

Width x Length in mm	Grit	Belt joint	Packing unit/pcs.	Cat. number
50 x 2000	36	F4G	10	26419
50 x 2000	40	F4G	10	26593
50 x 2000	60	F4G	25	72251
50 x 2000	80	F4G	25	26943
50 x 2000	120	F4G	25	103997
75 x 2000	24	F4G	10	4618
75 x 2000	36	F4G	10	4619
75 x 2000	40	F4G	10	4620
75 x 2000	60	F4G	10	4622
75 x 2000	80	F4G	10	26969
75 x 2000	120	F4G	10	113664
100 x 2000	36	F4G	10	26463
150 x 2000	36	F4G	10	26488

Continuation →

Other grits and sizes available on request.

Please observe: Minimum order quantities for manufactured items see page 41. Please see Applications Guide on page 38-45.

# Belts with cloth backing

Coated abrasives



→ Continuation of CS 411 X, Abrasive cloth

Width x Length in mm	Grit	Belt joint	Packing unit/pcs.	Cat. number
150 x 2000	40	F4G	10	26668
150 x 2000	60	F4G	10	72775
150 x 2000	80	F4G	10	27030
150 x 2000	120	F4G	10	101308

Abrasive cloth, waterproof

## CS 411 Y

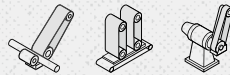

### Properties

Bonding agent	Resin
Grain	Zirconia alumina
Coating	Close
Backing	Y-polyester

### Applications:

Stainless steel	●
Steel	●
Metals	●

**Advantages:** Tear-resistant high-performance belt - Especially high aggressiveness and abrasive performance due to active abrasive substances - Especially for stainless steel, but also for steel and metal in general

Available grits:

16	24	30	36	40	50	60	80	100	120	150	180	220	240	280	320	360	400	500	600	800	1000	1200	1500	2000
----	----	----	----	----	----	----	----	-----	-----	-----	-----	-----	-----	-----	-----	-----	-----	-----	-----	-----	------	------	------	------

Width x Length in mm	Grit	Belt joint	Packing unit/pcs.	Cat. number
75 x 2000	24	F4G	10	62056
75 x 2000	36	F4G	10	62150
75 x 2000	40	F4G	10	62509
75 x 2000	50	F4G	10	62604
75 x 2000	60	F4G	10	62938
75 x 2000	80	F4G	10	63068
75 x 2000	120	F4G	10	20598
150 x 2000	36	F4G	10	62176
150 x 2000	40	F4G	10	62537
150 x 2000	60	F4G	10	62971
150 x 2000	80	F4G	10	63102
150 x 2000	120	F4G	10	278219

Other grits and sizes available on request.

Please observe: Minimum order quantities for manufactured items see page 41. Please see Applications Guide on page 38-45.

# Belts with cloth backing

Coated abrasives

Abrasive cloth, waterproof

## CS 412 Y

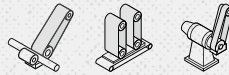

### Properties

Bonding agent	Resin
Grain	Aluminium oxide
Coating	Close
Backing	Y-polyester

### Applications:

Metals	●	Wood	ⓘ
NF metals	●		
Stainless steel	●		
Steel	●		

**Advantages:** High-quality universal type for wet and dry grinding of stainless steel, steel and other metal surfaces

### Available grits:

16 24 30 36 40 50 60 80 100 120 150 180 220 240 280 320 360 400 500 600 800 1000 1200 1500 2000

All sizes and minimum purchasing quantities available on request

Abrasive cloth, waterproof

## CS 416 Y

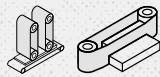

### Properties

Bonding agent	Resin
Grain	Zirconia alumina
Coating	Semi-open
Backing	Y-polyester

### Applications:

Stainless steel	●
Plastic	●
NF metals	ⓘ

**Advantages:** Very high aggressiveness and abrasive performance - Long service life also when used on materials that cause clogging

### Available grits:

16 24 30 36 40 50 60 80 100 120 150 180 220 240 280 320 360 400 500 600 800 1000 1200 1500 2000

Width x Length in mm	Grit	Belt joint	Packing unit/pcs.	Cat. number
75 x 2000	36	F4G	10	204858
75 x 2000	40	F4G	10	205377
75 x 2000	60	F4G	10	207651
75 x 2000	80	F4G	10	220805
150 x 2000	36	F4G	10	231336
150 x 2000	40	F4G	10	205474
150 x 2000	60	F4G	10	204213
150 x 2000	80	F4G	10	205130

Other grits and sizes available on request.

Please observe: Minimum order quantities for manufactured items see page 41. Please see Applications Guide on page 38-45.



# Belts with cloth backing

Coated abrasives



Abrasive cloth, NOPPEX

## CS 420 Y



### Properties

Bonding agent	Resin
Grain	Aluminium oxide
Backing	Y-polyester

### Applications:

Stainless steel	●
Steel	●

**Advantages:** Long-life abrasive belt with knob structure for a satin surface scratch pattern, under high to medium grinding pressure - Very suitable for centreless circular and surface grinding - Suitable for dry and wet grinding

Available grits:

16 24 30 36 40 50 60 80 100 120 150 180 220 240 280 320 360 400 500 600 800 1000 1200 1500 2000

All sizes and minimum purchasing quantities available on request

Abrasive cloth

## GX 533 JF

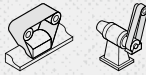

### Properties

Bonding agent	Resin
Grain	SiC
Coating	Close
Backing	JF-blended cloth

### Applications:

NF metals	●	Mineral based materials	●
Plastic	●		
Metals	●		
Titanium/Alloy	●		

**Advantages:** Special product for use on brass (sanitary fittings) and titanium (surgical instruments) - Good adaptation to radiuses and contours - High process reliability in robot applications or working with unsupported belts due to highly tear resistant blended fabric backing

Available grits:

16 24 30 36 40 50 60 80 100 120 150 180 220 240 280 320 360 400 500 600 800 1000 1200 1500 2000

All sizes and minimum purchasing quantities available on request

Abrasive cloth, multibond

## CS 631 XF



### Properties

Bonding agent	Resin
Grain	Ceramic Al. oxide
Coating	Semi-open
Backing	XF-cotton

### Applications:

Stainless steel	●
Titanium/Alloy	●

**Advantages:** Continuously aggressive abrasive performance, with long service life due to ceramic grit - Good adaptation to radiuses and contours - Prevents heat tinting on stainless steel due to multibond

Available grits:

16 24 30 36 40 50 60 80 100 120 150 180 220 240 280 320 360 400 500 600 800 1000 1200 1500 2000

All sizes and minimum purchasing quantities available on request

Other grits and sizes available on request.

Please observe: Minimum order quantities for manufactured items see page 41. Please see Applications Guide on page 38-45.



# Belts with cloth backing

Coated abrasives

Abrasive cloth

## CS 710 XF

**NEW**



### Properties

Bonding agent	Resin
Grain	Aluminium oxide
Coating	Close
Backing	XF-cotton

### Applications:

Steel	●
Stainless steel	●
NF metals	●

**Advantages:** Machine grinding of molded parts and weld seams in trade and industry - Flexible, yet tear-resistant backing - Abrasive belt with hardened and tempered aluminium oxide

### Available grits:

16 24 30 36 40 50 60 80 100 120 150 180 220 240 280 320 360 400 500 600 800 1000 1200 1500 2000

All sizes and minimum purchasing quantities available on request

Abrasive cloth

## GX 712 JF



### Properties

Bonding agent	Resin
Grain	Aluminium oxide
Coating	Close
Backing	JF-blended cloth

### Applications:

NF metals	●
Stainless steel	●
Steel	●
Metals	●

**Advantages:** Active abrasive substances ensure outstanding abrasive performance - Special product for tough/hard and heat-sensitive materials - Good adaptation to radiuses and contours - High process reliability in robot applications or working with unsupported belts due to highly tear resistant blended fabric backing.

### Available grits:

16 24 30 36 40 50 60 80 100 120 150 180 220 240 280 320 360 400 500 600 800 1000 1200 1500 2000

All sizes and minimum purchasing quantities available on request

Other grits and sizes available on request.

Please observe: Minimum order quantities for manufactured items see page 41. Please see Applications Guide on page 38-45.

# Belts with cloth backing

Coated abrasives



Abrasive cloth, waterproof

## CS 811 Y ACT



### Properties

Bonding agent	Resin
Grain	Zirconia alumina
Coating	Close
Backing	Y-polyester

### Applications:

Die-cast aluminium	●
Stainless steel	●
Steel	●

**Advantages:** High aggressiveness and abrasive performance - Developed for applications under high stress - Especially good grain adhesion and service life due to ACT recipe

### Available grits:

16 24 30 36 40 50 60 80 100 120 150 180 220 240 280 320 360 400 500 600 800 1000 1200 1500 2000

All sizes and minimum purchasing quantities available on request

Abrasive cloth, multibond

## CS 910 Y ACT



### Properties

Bonding agent	Resin
Grain	Ceramic Al. oxide
Coating	Close
Backing	Y-polyester

### Applications:

Stainless steel	●
Titanium/Alloy	●

**Advantages:** Continuously aggressive abrasive performance, with long service life due to ceramic grit - High-performance abrasive belt for stainless steel finish grinding - Prevents heat tinting on stainless steel - No clogging/glazing when used on titanium and high-alloy steels

### Available grits:

16 24 30 36 40 50 60 80 100 120 150 180 220 240 280 320 360 400 500 600 800 1000 1200 1500 2000

All sizes and minimum purchasing quantities available on request

Abrasive cloth, waterproof

## CS 912 Y ACT

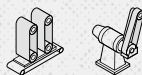

### Properties

Bonding agent	Resin
Grain	Ceramic Al. oxide
Coating	Close
Backing	Y-polyester

### Applications:

Stainless steel	●
Steel	●

**Advantages:** Continuously aggressive abrasive performance, with long service life due to ceramic grit - High-performance abrasive belt for stainless steel finish grinding

### Available grits:

16 24 30 36 40 50 60 80 100 120 150 180 220 240 280 320 360 400 500 600 800 1000 1200 1500 2000

All sizes and minimum purchasing quantities available on request

Other grits and sizes available on request.

Please observe: Minimum order quantities for manufactured items see page 41. Please see Applications Guide on page 38-45.

# Belts with cloth backing

Coated abrasives

Abrasive cloth, multibond

## CS 931 JF

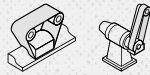

### Properties

Bonding agent	Resin
Grain	Ceramic Al. oxide
Coating	Semi-open
Backing	JF-cotton

### Applications:

Stainless steel	●
Titanium/Alloy	●

**Advantages:** Special product with high flexible backing for the processing of stainless steel and high-alloyed steel - Continuously aggressive grinding properties with high lifetime due to semiopen coated self-sharpening ceramic grain - Very good adaptability to radiuses and edges through high flexible backing - The additional multibond provides a "cool grinding" in the processing of stainless steel and thus tempering colours are avoided

### Available grits:

16 24 30 36 40 50 60 80 100 120 150 180 220 240 280 320 360 400 500 600 800 1000 1200 1500 2000

All sizes and minimum purchasing quantities available on request

Abrasive cloth, multibond

## GX 931 JF

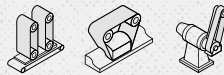

### Properties

Bonding agent	Resin
Grain	Ceramic Al. oxide
Coating	Semi-open
Backing	JF-blended cloth

### Applications:

Stainless steel	●
Titanium/Alloy	●

**Advantages:** Special product with flexible and tear resistant backing for the processing of stainless steel and high-alloyed steel - Continuously aggressive grinding properties with high lifetime due to semi-open coated self-sharpening ceramic grain - Good adaptability on radiuses and edges through flexible backing - High process reliability in robot applications or grinding slack of the belt because of extremely tear resistant polycotton backing - The additional multibond provides a cool grinding in the processing of stainless steel and avoids tempering colours

### Available grits:

16 24 30 36 40 50 60 80 100 120 150 180 220 240 280 320 360 400 500 600 800 1000 1200 1500 2000

All sizes and minimum purchasing quantities available on request

Other grits and sizes available on request.

Please observe: Minimum order quantities for manufactured items see page 41. Please see Applications Guide on page 38-45.

Non-woven web belt

## NBS 800

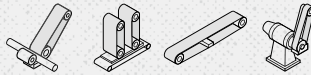

### Properties

Bonding agent	Resin
Grain	Aluminium oxide

### Applications:

Stainless steel	●
NF metals	●
Metals	○

**Advantages:** Special product for surface finishing with hand-operated machines (except hand tool belt grinders) and stationary machines - Ideal for removal of discolorations, for light deburring, leveling, matte finishing and roughening - Minimal clogging - Long service life - Suitable for dry and wet grinding

Width x Length in mm	Belt joint	Colour	Grade	Packing unit/pcs.	Cat. number
30 x 800	F3W	maroon	medium	5	258706
40 x 618	F3W	brown	coarse	5	258711
40 x 618	F3W	maroon	medium	5	258712
40 x 618	F3W	blue	very fine	5	258713
40 x 820	F3W	brown	coarse	5	258714
40 x 820	F3W	maroon	medium	5	258715
40 x 820	F3W	blue	very fine	5	258716
50 x 450	F3W	brown	coarse	5	258717
50 x 450	F3W	maroon	medium	5	258718
75 x 2000	F3W	brown	coarse	5	258729
75 x 2000	F3W	maroon	medium	5	258730
75 x 2000	F3W	blue	very fine	5	258731

Grit	60 - 80	120 - 150	180 - 240
Grade	coarse	medium	very fine
Klingspor non-woven web belts	Aggressiveness decreasing ↓	coarse A – brown	
			medium A – maroon
			very fine – blue

Other grades and sizes available on request.

Please observe: Minimum order quantities for manufactured items see page 41. Please see Applications Guide on page 38-45.

# Abrasive sleeves

Coated abrasives

Abrasive cloth

## CS 310 X

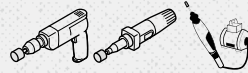

### Properties

Bonding agent	Resin
Grain	Aluminium oxide
Coating	Close
Backing	X-cotton

### Applications:

Metals	●
Plastic	○

**Advantages:** Tear-resistant cloth with reinforced backing - Spiral shaped joint, cylindrical form - Universal applications in metalworking - High aggressiveness when used with rubber drum GK 555

### Available grits:

16	24	30	36	40	50	60	80	100	120	150	180	220	240	280	320	360	400	500	600	800	1000	1200	1500	2000
----	----	----	----	----	----	----	----	-----	-----	-----	-----	-----	-----	-----	-----	-----	-----	-----	-----	-----	------	------	------	------

Diameter x Height in mm	Grit	Packing unit/pcs.	Cat. number
10 x 20	80	50	11555
10 x 20	150	50	11554
13 x 25	50	50	28188
13 x 25	80	50	11558
15 x 30	50	50	11568
15 x 30	80	50	11567
15 x 30	150	50	11566
22 x 20	50	50	11571
22 x 20	80	50	11570
22 x 20	150	50	11569
30 x 20	50	50	11574
30 x 20	80	50	11573
30 x 20	150	50	11572
30 x 30	50	50	11577
30 x 30	80	50	11576
30 x 30	150	50	11575
45 x 30	50	50	11580
45 x 30	80	50	11579
45 x 30	150	50	11578
60 x 30	50	25	11583
60 x 30	80	25	11582
60 x 30	150	25	11581
75 x 30	50	25	11586
75 x 30	80	25	11585
75 x 30	150	25	11584

Other grits and sizes available on request.

Please observe: Minimum order quantities for manufactured items see page 41. Please see Applications Guide on page 38-45.

# Abrasive sleeves

Coated abrasives



Abrasive cloth

## CS 310 X

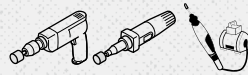

### Properties

Bonding agent	Resin
Grain	Aluminium oxide
Coating	Close
Backing	X-cotton

### Applications:

Metals	●
Plastic	⊙

**Advantages:** Tear-resistant cloth with reinforced backing - Spiral shaped joint, conical form - Universal applications in metalworking - High aggressiveness when used with rubber drum GK 555 A

Available grits:

16	24	30	36	40	50	60	80	100	120	150	180	220	240	280	320	360	400	500	600	800	1000	1200	1500	2000
----	----	----	----	----	----	----	----	-----	-----	-----	-----	-----	-----	-----	-----	-----	-----	-----	-----	-----	------	------	------	------

Diameter 1 x Diameter 2 x Height in mm	Grit	Packing unit/pcs.	Cat. number
22 x 29 x 30	50	50	11592
22 x 29 x 30	80	50	11591
22 x 36 x 60	50	50	11595
22 x 36 x 60	80	50	11594
22 x 36 x 60	150	50	11593

Abrasive cloth, multibond

## CS 451 X

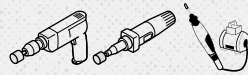

### Properties

Bonding agent	Resin
Grain	Zirconia alumina
Coating	Close
Backing	X-cotton

### Applications:

Stainless steel	●
-----------------	---

**Advantages:** Tear-resistant cloth with reinforced backing - Spiral shaped joint, cylindrical form - High-quality zirconia alumina with multibond especially suited for working on stainless steel - High aggressiveness when used with rubber drum GK 555

Available grits:

16	24	30	36	40	50	60	80	100	120	150	180	220	240	280	320	360	400	500	600	800	1000	1200	1500	2000
----	----	----	----	----	----	----	----	-----	-----	-----	-----	-----	-----	-----	-----	-----	-----	-----	-----	-----	------	------	------	------

Diameter x Height in mm	Grit	Packing unit/pcs.	Cat. number
30 x 20	40	50	334246
30 x 20	60	50	255475
45 x 30	40	50	334247
45 x 30	60	50	255476
60 x 30	40	25	334248
60 x 30	60	25	255626

Other grits and sizes available on request.

Please observe: Minimum order quantities for manufactured items see page 41. Please see Applications Guide on page 38-45.



# Rubber drums

Rubber drums

## GK 555



**Advantages:** Reusable rubber drum for cylindrical abrasive sleeves CS 310 X and CS 451 X - Mounting and dismounting by a light turn

Diameter x Width x Shaft in mm	Max. operating speed	Max. RPM	Packing unit/pcs.	Cat. number
10 x 20 x 6	30 m/s	44000 rpm	1	14843
13 x 25 x 6	30 m/s	44000 rpm	1	14845
15 x 30 x 6	30 m/s	36000 rpm	1	14847
22 x 20 x 6	30 m/s	26000 rpm	1	14848
30 x 20 x 6	30 m/s	19100 rpm	1	14849
30 x 30 x 6	30 m/s	19100 rpm	1	14850
45 x 30 x 6	30 m/s	12700 rpm	1	14851
60 x 30 x 6	30 m/s	9500 rpm	1	14852
75 x 30 x 8	30 m/s	7600 rpm	1	14853

Rubber drums

## GK 555 A



**Advantages:** Reusable rubber drum for cone-shaped abrasive sleeves CS 310 X - Mounting and dismounting by a light turn

Diameter 1 x Diameter 2 x Height x Shaft in mm	Max. operating speed	Max. RPM	Packing unit/pcs.	Cat. number
22 x 29 x 30 x 6	30 m/s	19100 rpm	1	14855
22 x 36 x 60 x 6	30 m/s	15900 rpm	1	14856



---

A large grid of small dots for taking notes, consisting of approximately 30 columns and 40 rows of dots.

# Wide belts

Applications guide

## Belt joints for wide belts

Klingspor supplies belts with various types of joint. The type of joint you require depends on the work involved and the machine you are using.

The following illustrations show the usual types of joint. The available types of joint are listed in the product charts on the following product pages.

The chart alongside contains all the standard types of machines for wide belts. Please contact us if you cannot find the machine used by you on this list. We will be pleased to assist you further.

**If the product you require is not in stock, we will manufacture it for you subject to a minimum order quantity.**

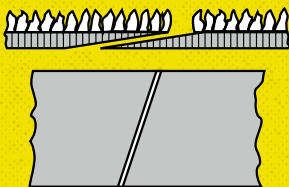

**Form 1**  
Overlapping glued joint. Standard joint for wide belts with paper backing.

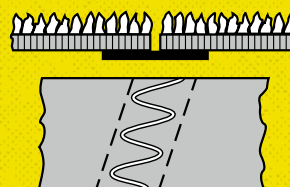

**Form 3 G**  
Zig zag joint, with foil backing for finishing surfaces that must be of the highest quality using wide belts with cloth backing.

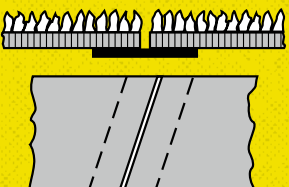

**Form 4 G**  
Butt joint with cloth-reinforced foil backing. Standard joint for wide belts with cloth backing. High tear resistance.

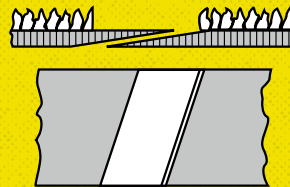

**Form 5**  
Overlapping glued joint. Grit zone is completely ground off. For applications with flat contact elements, allows a gentle transition in the belt connection area.

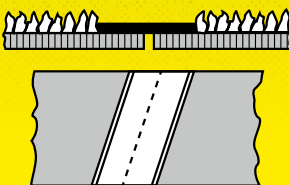

**Form 6 G**  
Butt joint with cloth-reinforced foil glued on grit side. Grit zone is completely ground off. Use in the timber products industry.

# Wide belts

Applications guide



## Wide belt machines

Manufacturer	Type	Abrasive belt size		Manufacturer	Type	Abrasive belt size	
		Width in mm	Length in mm			Width in mm	Length in mm
Anthon	Saphir Combi 1100/1300, Saphir WS 1100/1300, Saphir WWS 1100/1300, Saphir 110/130, Saphir L, Saphir L-series	1120/1320	1900	Super RRF/RRL 311/313, Super RLF 311/313, Super MRL 311/313	1120/1370	1900	
	CMOWKS	900/1100/1300	2500		SWO 313 RRF	1370	2620
Biesse	Levia 95	970	1900	SWT 113 K	970	1900	
	Levia 110	1120	2150	SWT 142 RK, SWT 124 MK, SWT 124 RC, SWT 134 RCC, SWT 134 RRK	1120	1900	
	Levia 110R	1115	2620	SWT 315 C, SWT 325 RL, SWT 325 RC, SWT 325 RH, SWT 325 CC, SWT ww 325 CH, SWT 325 QC, SWT 335 RQE, SWT 335 RQH, SWT 335 QCE, SWT 335 RRL, SWT 335 RRC	1370	2620	
	Levia 135, Levia 135R 2, Levia 135R 3	1370	2150	SWT 515 C	1370	2150	
	Levia 210, Levia 220	970	1900	SWT 525 CC, SWT 525 CH, SWT 525 QC, SWT 525 QH, SWT 535 RQE, SWT 535 RQH, SWT 535 QCE, SWT 535 QCH	1370	2620	
	Levia 310, Levia 320, Levia 330	1120/1370	2150	SWT 700	1350/1650	2620/3250	
	Regal 135 2, Regal 135 3, Regal 520, Regal 530	1370	2620	SWT 900	1350/1650/2200	2620/3250	
Regal 320, Regal 330	1120/1370	2620	Vega 111, Vega 211 C-E, Vega 311	1120	2150		
Boere	B, Kombi, Sandonomic C, Sandonomic KC	610/810/910/1010/1110/1310	1900	Vega 113, Vega 213 C-E, Vega 313	1370	2150	
	Elite B	610/910/1100/1310	1900	Libra 1 (TC 95, RR 95, RT 95, RTC 95)	970	2200	
	Elite B/T	610/910	1900	Libra 2 (TC 110, RR 110, RT 110, RTC 110)	1120	2200	
	Elite B/T	1110/1310/1660	2620	Libra 3 (110 RRT, 110 RRR, 110 RRCT)	1120	2200	
	Elite-LAC K, Elite-LAC KK	1100/1300	2620	Libra 4/2 (RR 135, RT 135, RTC 135, TCTC 135, TCT 135, TT 135)	1380	2620	
	Elite-T	610/910/1110/1310	1900	Libra 4/3 (RRR 135, RRT 135, RTCT 135, RRCT 135, RTT 135, RTCT 135)	1380	2620	
	Elite TP	910/1110/1310	1900	Libra 6 (RT 115, RR 115, RT 135, RR 135)	1180/1380	2620	
	Merite C, Merite KC	1010	1900	Libra 10	970	1525	
	MT C, MT KS/KK, MT KKS/KKK	410/610/940	1525	Libra 30 (RTC 95, TC 110, RTC 110)	970/1115	1900	
	Sandrite C, Sandrite KC	1110/1310	1900	Libra 40, Libra 40/3 (RR110, RTC 110, RRR 110, RRCT 110, TC 135, RR 135, RTC 135, RRR 135, RRCT 135)	1115/1370	2200	
Büftering	Select C, Select K, Select KC, Select KK, Select KS, Select KKC, Select KKK, Select KKS, Select CB, Select KSB	910/1110/1310	1900	Libra 50 (RR 135, RTC 135, RRR 135, RRCT 135)	1370	2620	
	Select +plus+	1370	2620	Libra 60 (RR135, RTC 135, RRR 135, RRCT 135)	1370	2620	
	AF 2, AF 3	1110/1360	2620	LEV 95 RT/RR/R+T	970	1900	
	AL-E	1360	2620	LEV 115 RT/RR/R+T	1180	1900	
	AWS 2, AWS 3, AWS Combi	1110/1360	1900	A, A1, AK, AF, AKF, AW1	1180/1380	2620	
	Optimat SBC 111/113/Classic, Optimat SBC 211/312/Classic, Optimat SBC 311/313/Classic	1120/1370	1900	K, KA, KB, KH, KK, KP, KBA, KBH, KHV, KKA, KKH, KKP, KPH	1350/1650	2620/3250	
	Optimat SBC 213/QC/Classic, Optimat SBC 313/QCE/Classic, Optimat SBC 313/RQE/Classic	1370	1900/2620	Elite CK, C/400, CT, CC, C/CK, CK/T	1150/1350	2620	
	E-Line 111, E-Line 211, E-Line 311	1120	1900	S, SA, SP	1150/1350	2620	
	E-Line 113, E-Line 213, E-Line 313	1370	1900	S4	1380/1680	4600	
	ECO 1100, ECO 2 K, ECO 2 KC, ECO 2 KK, ECO 2 C-E, ECO 2 K-E	1120	1900	SN	1380/1680	2620/3250	
	PRO 111, PRO 211	1120	1900	SH	1380	2620/3250	
	SBO 109	970	1900	SK (Serie 4)	1150	2200	
	SCO 213 CC, SCO 213 CH, SCO 213 QC, SCO 213 QH	1370	2620	SK (Serie 5, Serie 6)	1380	2620	
	SGO 109 K	970	1900	K (Serie 7)	350-1650	2620/3250	
	SGO 211 K, SGO 211 RK, SGO 211 MK, SGO 311 RKK	1120	1900	K (Serie 8)	1350-2200	2620/3250	
	SKO 111 C	1120	1900	K (Serie 9)	1650-3000	3250/4600	
	SKO 113 C, SKO 213 RC, SKO 213 CC	1370	1900				
STO 111 L, STO 211 RL	1120	1900					
STO 113 L, STO 213 RL, STO 313 RRL	1370	1900					
Super 109 L, Super 209 RL	970	1900					
Super 111 L, Super 211 RL	1120	1900					
Super 113 L, Super 213 RL	1370	1900					

Wide Belts

# Wide belts

Applications guide

## Wide belt machines

Manufacturer	Type	Abrasive belt size		Manufacturer	Type	Abrasive belt size	
		Width in mm	Length in mm			Width in mm	Length in mm
DMC	Chronosand	1115/1315	2620	Holzmann	SPB 300R, SPB 300C, SPB 300RR, SPB 300RC	320	1900
	Eurosand L	1115/1370	2620		SPB 400R, SPB 400C, SPB 400RR, SPB 400RC	420	1900
	Mastersand 110, Mastersand 135	1115/1370	2620		SPB 430R, SPB 430C	450	1600
	Polisand	1130/1330	2200/2620		SPB 630R, SPB 630C	650	1600
	System 1350 RK	1370	2620		SPB 630R, SPB 630 RR, SPB 630RC	650	1900/2200
	System T2 1350, System T3 1350, System T5 1350, System T7 1350	1370	2620		SPB 910R, SPB 910C, SPB 910RC, SPB 910RR	930	1900/2200
	System BT44 1350	1370	2620		RP 950B	980	1900
	System BT22 2200	2220	2620		RRP 650 B	680	1900
	System T10	1370	2620		RRP 1000B	1030	2200
	Technosand K	1115/1370	2620		Aerostat	1130/1330	2200
	Technosand L	1115	2620	Aerostat I 1K	1050/1130/1350	1900	
	Topsand 2000	1370/1670/1920/2270	3250	Aerostat I 2 RS	1050/1130	1900	
	Unisand 2000	1370	2620	Aerostat II 2 RS, Aerostat II 2 RK, Aerostat 2 KS, Aerostat 2 KK	1130/1350	1900	
	Unisand K	1115/1370	2620	Compact 1K	1050	1900	
Linea Unisand K	1115/1370	1900	Compact 2 RS, Compact 2 RK	1050/1130	1900		
EMC	Explorer	670/970/1120	1900	MT 2/1100	1150	1900	
	Explorer Super	670/970/1120	2200	Primo, Triplex, Magiq, Topiq	1120/1350	2000	
	Giant	1370	2620	Enorm DUO 1100	1120	1900	
	Under-Top	1120	1900	Duplex	670/1120/1350/1620	2000	
	Venus	1120/1370	2200	Premium, Brilliant, Technic	420/670/1120/1350/1620/1920/2220	2000	
	Venus Super	1120/1370	2620	Alpha, Alphontronic	1120/1380	2150	
Ernst	820 (SIMPLEX, DUPLEX, KOMBI)	1400	2150	Comet 1	1120/1380	1900	
	Economic 520 (SIMPLEX, DUPLEX)	1400	2620	Comet 2, Comet 3	1100/1360	1900	
	LKKB(B)/K, LKB(B)/K, KBB/K	1400	2620/3150	Delta	1400	2150	
	EG 3 M/1400	1400	1540	Deltatronic	1120/1380	2150	
	EM 5N 900	900	1540	Euro	1120/1380	1900	
	EM 3N 1400, EGM 3M 1400	1400	1690	Euro 95 WS	970	1900	
	510, 530, 810, 830, 850	1400	2620	Lambda, Lambda KSE 2	1360	2620	
Felder	FW 650	670	1900	Megatronic	1120/1380	1900	
	FW 950 classic	970	1700	Omega, Omegatronic	1120/1380	2150	
	FW 952	970	1900	RSK-0	1120	1900	
	FW 1100, FW 1102	1110	1900	CSB-400	430	1600	
Format 4 (Felder Group)	finish 1102, finish 1302	1110/1310	2200	CSB-600, CSB-900, SCSB-1100, SCSB-1300	630/930/1130/1330	1900	
	Giant 1350	1350	4550	CSB-1600, CSB-1950	1630/1980	2620	
Griggio	GC65, GC95, GC110	670/970/1120	2150	CSB 2-600, CSB 2-900, SCSB 2-1100, SCSB 2-1300	630/930/1130/1330	1900	
	GI 1000 RR/RRT, GI 1300 RR/RRT	1120/1370	2620	CSB 2-1050, CSB 2-1300, CSB 2-1600, CSB 2-1950	1080/1330/1630/1980	2620	
Heesemann	MFA 10	1400	2620/3250	CSB 3-600, CSB 3-900, SCSB 3-1100, SCSB 3-1300	630/930/1130/1330	1900	
	EH 31.11	1120	1900	CSB 3-1050, CSB 3-1300, CSB 3-1600, CSB 3-1950	1080/1330/1630/1980	2620	
	EH 51.11, EH 52.11	1120	2150	KCSB-U	930/1130/1330	1900	
	EH 51.13, 52.13	1370	2150	SA 2100 W, SA 2100 C, SA 2100 K	600/900/1100/1350	1900	
	FBA 8	700/1400	2620	SA 2200 WW, SA 2200 WS, SA 2200 WC	600/900/1100/1350	1900	
	KSA 4	1350	3250	SA 2200 WK, SA 2200 WG	1100/1350	1900	
	KSA 8	1650/2050/2350/2650	2620/3250	SA 2200 KG	1100	1900	
	LSM 4-U, LSM 8	1350	2620/3250	SA 2300 WWW, SA 2300 WWS	600/900/1100	1900	
	LSM 6, KSM 8	1350	2620	SA 3100 W, SA 3100 C, SA 3100 K	900/1100/1350	1900	
	LAZ 2	1400	2100				
	MFA 6, MFA 6 Impression, MFA 8, MFA Impression	1400	2150/2620				
	Holzkraft	BBS 430 C	450	1600			
		BBS 630 C	650	1600			
BSH 650 HP		650	1900				
BSM 1100 RP		1100	1900				

# Wide belts

Applications guide



## Wide belt machines

Manufacturer	Type	Abrasive belt size		Manufacturer	Type	Abrasive belt size			
		Width in mm	Length in mm			Width in mm	Length in mm		
Sanding-master / Timesavers	SA 3200 WW, SA 3200 WS, SA 3200 WC, SA 3200 PW, SA 3200 PC, SA 3200 WK, SA 3200 WG, SA 3200 KG	900/1100/1350	1900	Klingspor	Sandya 5	1115	1900		
	SA 3100 W, SA 3100 C, SA 3100 K	900/1100/1350	1900		Sandya 5 S, Sandya 600, Sandya 75	1115/1370	2150		
	SA 3200 WW, SA 3200 WS, SA 3200 WC, SA 3200 PW, SA 3200 PC, SA 3200 WK, SA 3200 WG, SA 3200 KG	900/1100/1350	1900		Sandya 10/2, Sandya 10/3	1115/1320	2150		
	SA 3300 WWW, SA 3300 WWS, SA 3300 WWC, SA 3300 PWS, SA 3300 PWC, SA 3300 WWK, SA 3300 WWG	900/1100/1350	1900		Sandya 10S, Sandya 15S, Sandya 16S	1115/1370	2620		
	SA 3400 WWWW, SA 3400 WWWS, SA 3400 WWWC	900/1100/1350	1900		Sandya 20, Sandya 9S	1115/1370	2620		
	SA 4100 W	1100/1350	2620		Sandya 30 CS	1315	2300		
	SA 4200 WW, SA 4200 WS, SA 4200 PW, SA 4200 WG, SA 4200 DW	1100/1350	2620		Sandya 30 CLK, Sandya 7	1115	2150		
	SA 4300 WWW, SA 4300 WWS, SA 4300 PWS, SA 4300 WWG, SA 4300 DWG, SA 4300 DKG	1100/1350	2620		Sandya 30 CL	1315	2150		
	SA 4400 WWWW, SA 4400 WWWS, SA 4400 WWKG	1100/1350	2620		Sandya 30/2, Sandya 30/3	930/1115/1315	2620		
	SCSB	630/930/1130/1330	1900		Sandya 40	1370	2620		
	SCSB2	630/930/1130/1330	1900		Sandya 50	1115/1315	1900		
	SCSB3	630/930/1130/1330	1900		Sandya 60	1115	2620		
	Timesavers-Grindingmaster 2000 Serie	600/900/1100/1350	1900		Sandya L90	915	2150		
	Timesavers-Grindingmaster 2100 Serie	600/900/1100/1350	1900		Sandya 90 CLX4G, Sandya 30 RRT130	1315	2620		
	Timesavers-Grindingmaster 2200 Serie	900/1100	1900		Sandya Win	640	1525		
	Timesavers-Grindingmaster 2200 Serie	1300	2620		Tagliabue	EuroSander 1350	1350 – 1400	2620/3250	
	Timesavers-Grindingmaster 3100 Serie	600/900	1525			EuroSander 1700	1650 – 1730	2620/3250	
	Timesavers-Sandingmaster 3300 Serie	900/1100/1350	1900/2150/2620			TAG	1400	2620/3250	
	Timesavers-Grindingmaster 4100 Serie	600/900/1350	1900			TAG E	1400	2620	
	Timesavers-Grindingmaster 4200 Serie	600/900/1350	1900			TAG EU	1400	2620/3250	
	Speedsander	930	1525			TAG L	430/630/830	2620	
	137-1HDMW	940	1525			Viet	Challenge 111/113, Challenge 211/213, Challenge 221/223, Challenge 321/323, Challenge 331/333	1130/1380	2620
	137-1HD60	940	1525				Challenge 111AK, Challenge 211A, Challenge 211AK, Challenge 221AK, Challenge 221A	1130	2200
	137-1HPM	940	1905		Challenge 221B/223B		1130/1380	2620	
	143-1HD60	1090	1525		Rita 3/CC, Rita 4/CC		1400	3250	
	CL 63TS, CL 110, CL 130	640/1115/1315	2150		S1, S2		1130/1380	2200/2620	
	Sandya CL 110M	1115	2150		S3		1130/1380/1630	2620	
	CS92, CS110, CS130	930/1115/1315	2300		S4		1380	3250	
	Sandya Uno (CC, CS, CCS, RR, RCS)	930	1525		S211, S219		1000	1900	
	Sandya 1K, Sandya 1S	970	1525		Valeria 1, 2, 3	1400	3250		
Sandya 3	970	1900	Weber	KSF	1120/1370/1620	2150/2620			
Sandya 3 S, Sandya 300	970/1115	1900		KSV	1120/1370/1620/1920/2270	2620			
				KSL	1370/1620	2620			
				OFZ-K1(o), -K2(o), -K3(o)	950/1150/1400	2050/2500			
				OFZ KS/Q	1400	2500			
				Weber 600	1120/1370	1900			
				Weber 1000	1120/1370	2150			
				LCS	1100/1300	1900			
				LCE compact	1100/1350	1900			
				TT, MKS	600/1100/1350/1600	2150			
				MK	920/1120/1370/1620/2020	2620			
				KLE	1400	2620			



# Wide belts with paper backing

Coated abrasives

Abrasive paper

## PS 20 F



### Properties

Bonding agent	Resin
Grain	Aluminium oxide
Coating	Close
Backing	F-paper

### Applications:

Stainless steel	●
Metals	●
NF metals	●
Steel	○

**Advantages:** Universal product for stainless steel finish grinding - High cutting rate

Available grits:

16 24 30 36 40 50 60 80 100 120 150 180 220 240 280 320 360 400 500 600 800 1000 1200 1500 2000

All sizes and minimum purchasing quantities available on request

Abrasive paper

## PS 21 F



### Properties

Bonding agent	Resin
Grain	Zirconia alumina
Coating	Close
Backing	F-paper

### Applications:

Stainless steel	●
Metals	●
Steel	●

**Advantages:** Aggressive abrasive behaviour due to self-sharpening zirconia alumina - Optimal recipe for rough grinding and finish grinding of stainless steel

Available grits:

16 24 30 36 40 50 60 80 100 120 150 180 220 240 280 320 360 400 500 600 800 1000 1200 1500 2000

All sizes and minimum purchasing quantities available on request

Other grits and sizes available on request.

Please observe: Minimum order quantities for manufactured items see page 41. Please see Applications Guide on page 39-41, 80-83.

# Wide belts with paper backing

Coated abrasives



Abrasive paper, ANTISTATIC

## PS 22 F ACT



### Properties

Bonding agent	Resin
Grain	Aluminium oxide
Coating	Close
Backing	F-paper

### Applications:

Wood	●	Plastic	○
Metals	○		
NF metals	○		
Paint/Varnish/Filler	○		

**Advantages:** High removal rate, fine surface scratch pattern, especially suitable for hardwood, HPL panels and melamine and primer foil coatings - Reduced clogging and longer service life due to ACT recipe and antistatic properties

Available grits:

16 24 30 36 40 50 60 80 100 120 150 180 220 240 280 320 360 400 500 600 800 1000 1200 1500 2000

All sizes and minimum purchasing quantities available on request

Abrasive paper, ANTISTATIC

## PS 24 F ACT



### Properties

Bonding agent	Resin
Grain	SiC
Coating	Close
Backing	F-paper

### Applications:

Stainless steel	●
Paint/Varnish/Filler	●
Plastic	●
Wood	○

**Advantages:** For hard and tough surfaces - Produces a brilliant, high gloss finish on stainless steel surfaces due to the very hard and sharp-edged silicon carbide grit - Long service life on varnish surfaces in the wood and furniture industry due to ACT recipe and antistatic properties

Available grits:

16 24 30 36 40 50 60 80 100 120 150 180 220 240 280 320 360 400 500 600 800 1000 1200 1500 2000

All sizes and minimum purchasing quantities available on request

Other grits and sizes available on request.

Please observe: Minimum order quantities for manufactured items see page 41. Please see Applications Guide on page 39-41, 80-83.

# Wide belts with paper backing

Coated abrasives

Abrasive paper, ANTISTATIC

## PS 27 DW



### Properties

Bonding agent	Resin
Grain	SiC
Coating	Open
Backing	D-paper

### Applications:

Paint/Varnish/Filler	●
Aluminium	●
Plastic	○

**Advantages:** Special product for high-quality varnish surfaces, especially UV finishes - Substantially reduced clogging and significantly longer service life due to additional stearate coating and antistatic properties

Available grits:

16 24 30 36 40 50 60 80 100 120 150 180 220 240 280 320 360 400 500 600 800 1000 1200 1500 2000

All sizes and minimum purchasing quantities available on request

Abrasive paper, ANTISTATIC

## PS 28 F



### Properties

Bonding agent	Resin
Grain	Aluminium oxide
Coating	Open
Backing	F-paper

### Applications:

Wood	●
Leather	●

**Advantages:** Universal type for use on wood, especially softwood - For wide belts up to 1350 mm

Available grits:

16 24 30 36 40 50 60 80 100 120 150 180 220 240 280 320 360 400 500 600 800 1000 1200 1500 2000

Width x Length in mm	Grit	Belt joint	Packing unit/pcs.	Cat. number
1120 x 1900	60	F1	10	321842
1120 x 1900	80	F1	10	321843
1120 x 1900	120	F1	10	321845
1120 x 1900	150	F1	10	321846
1350 x 2620	60	F1	10	320413
1350 x 2620	80	F1	10	320414
1350 x 2620	150	F1	10	320417

Other grits and sizes available on request.

Please observe: Minimum order quantities for manufactured items see page 41. Please see Applications Guide on page 39-41, 80-83.

# Wide belts with paper backing

Coated abrasives



Abrasive paper, ANTISTATIC

## PS 29 F ACT



### Properties

Bonding agent	Resin
Grain	Aluminium oxide
Coating	Open
Backing	F-paper

### Applications:

Wood	●
------	---

**Advantages:** High-quality universal type for general woodworking - Large product mix - Reduced clogging and longer service life due to ACT recipe and antistatic properties

### Available grits:

16	24	30	36	40	50	60	80	100	120	150	180	220	240	280	320	360	400	500	600	800	1000	1200	1500	2000
----	----	----	----	----	----	----	----	-----	-----	-----	-----	-----	-----	-----	-----	-----	-----	-----	-----	-----	------	------	------	------

Width x Length in mm	Grit	Belt joint	Packing unit/pcs.	Cat. number
930 x 1525	80	F1	10	307852
930 x 1525	120	F1	10	307854
1100 x 1900	80	F1	10	307857
1100 x 1900	120	F1	10	307859
1120 x 1900	60	F1	10	292903
1120 x 1900	80	F1	10	292904
1120 x 1900	100	F1	10	292935
1120 x 1900	120	F1	10	292936
1120 x 1900	150	F1	10	292937
1120 x 2150	80	F1	10	307863
1120 x 2150	120	F1	10	307865
1350 x 2620	60	F1	10	292938
1350 x 2620	80	F1	10	292939
1350 x 2620	120	F1	10	292941
1350 x 2620	150	F1	10	292942
1350 x 2620	180	F1	10	307867

Other grits and sizes available on request.

Please observe: Minimum order quantities for manufactured items see page 41. Please see Applications Guide on page 39-41, 80-83.

# Wide belts with paper backing

Coated abrasives

Abrasive paper, ANTISTATIC

## PS 38 G ACT



### Properties

Bonding agent	Resin
Grain	SiC
Coating	Close
Backing	G-paper

### Applications:

Wood based materials	●
Wood	●
Composite materials	●
Mineral based materials	●

**Advantages:** High removal rate and fine surface scratch pattern - Developed for fine sanding of wood based materials with wide belts and segmented belts - Outstanding grit adhesion, very long service life due to perfect antistatic properties and ACT recipe

Available grits:

16 24 30 36 40 50 60 80 100 120 150 180 220 240 280 320 360 400 500 600 800 1000 1200 1500 2000

All sizes and minimum purchasing quantities available on request

Abrasive paper

## PS 61 F



### Properties

Bonding agent	Resin
Grain	Ceramic Al. oxide
Coating	Close
Backing	F-paper

### Applications:

Stainless steel	●
Steel	●
Wood	○

**Advantages:** Continuously aggressive abrasive behaviour due to micro-crystalline and self-sharpening ceramic grit - High performance abrasive belt for stainless steel finish grinding

Available grits:

16 24 30 36 40 50 60 80 100 120 150 180 220 240 280 320 360 400 500 600 800 1000 1200 1500 2000

All sizes and minimum purchasing quantities available on request

Other grits and sizes available on request.

Please observe: Minimum order quantities for manufactured items see page 41. Please see Applications Guide on page 39-41, 80-83.

# Wide belts with paper backing

Coated abrasives



Abrasive paper, KULEX

## PS 729 F



### Properties

Bonding agent Resin	
Grain	Al. oxide agglom.
Backing	F-paper

### Applications:

Stainless steel	●
Steel	●

**Advantages:** Long life belt for dry grinding applications - Extremely high service life - Constant surface quality for pre-grinding until finishing - Especially developed grinding with intermediate contact pressure

### Available grits:

16 24 30 36 40 50 60 80 100 120 150 180 220 240 280 320 360 400 500 600 800 1000 1200 1500 2000

All sizes and minimum purchasing quantities available on request

Other grits and sizes available on request.

Please observe: Minimum order quantities for manufactured items see page 41. Please see Applications Guide on page 39-41, 80-83.



# Wide belts with cloth backing

Coated abrasives

Abrasive cloth

## CS 308 Y



### Properties

Bonding agent	Resin
Grain	Aluminium oxide
Coating	Close
Backing	Y-polyester

### Applications:

Wood	●	Plastic	ⓘ
NF metals	●		
Stainless steel	●		
Steel	●		

**Advantages:** Universal product for metal and wood applications - High tear resistance - Moisture proof

Available grits:

16 24 30 36 40 50 60 80 100 120 150 180 220 240 280 320 360 400 500 600 800 1000 1200 1500 2000

All sizes and minimum purchasing quantities available on request

Abrasive cloth

## CS 310 X



### Properties

Bonding agent	Resin
Grain	Aluminium oxide
Coating	Close
Backing	X-cotton

### Applications:

Metals	●	Plastic	ⓘ
Steel	●		
Stainless steel	●		
Wood	ⓘ		

**Advantages:** Universal product with optimal price-performance ratio - Available in a wide grit range

Available grits:

16 20 24 30 36 40 50 60 80 100 120 150 180 220 240 280 320 360 400 500 600 800 1000 1200 1500 2000

All sizes and minimum purchasing quantities available on request

Other grits and sizes available on request.

Please observe: Minimum order quantities for manufactured items see page 41. Please see Applications Guide on page 39-41, 80-83.

# Wide belts with cloth backing

Coated abrasives



Abrasive cloth ANTISTATIC

## CS 311 Y ACT



### Properties

Bonding agent	Resin
Grain	Aluminium oxide
Coating	Open
Backing	Y-polyester

### Applications:

Wood	●
Metals	⓪

**Advantages:** Specially developed for calibration grinding of wood - Reduced clogging and longer service life due to ACT recipe and antistatic properties

Available grits:

16 24 30 36 40 50 60 80 100 120 150 180 220 240 280 320 360 400 500 600 800 1000 1200 1500 2000

All sizes and minimum purchasing quantities available on request

Abrasive cloth, waterproof

## CS 320 Y



### Properties

Bonding agent	Resin
Grain	SiC
Coating	Close
Backing	Y-polyester

### Applications:

Mineral based materials	●
Plastic	●

**Advantages:** Very hard and sharp silicon carbide grain for hard and tough workpiece surfaces - High aggressiveness and abrasive performance - Especially suitable for wet grinding

Available grits:

16 24 30 36 40 50 60 80 100 120 150 180 220 240 280 320 360 400 500 600 800 1000 1200 1500 2000

All sizes and minimum purchasing quantities available on request

Other grits and sizes available on request.

Please observe: Minimum order quantities for manufactured items see page 41. Please see Applications Guide on page 39-41, 80-83.

# Wide belts with cloth backing

Coated abrasives

Abrasive cloth, waterproof

## CS 321 X



### Properties

Bonding agent	Resin
Grain	SiC
Coating	Close
Backing	X-cotton

### Applications:

Mineral based materials	●
Plastic	●
Stainless steel	●

**Advantages:** Produces a brilliant, glossy finish on stainless steel surfaces due to the very hard and sharp-edged silicon carbide grit - Very high aggressiveness and abrasive performance - Especially suitable for wet grinding

Available grits:

16 24 30 36 40 50 60 80 100 120 150 180 220 240 280 320 360 400 500 600 800 1000 1200 1500 2000

All sizes and minimum purchasing quantities available on request

Abrasive cloth, KULEX

## CS 326 Y



### Properties

Bonding agent	Resin
Grain	Al. oxide agglom.
Backing	Y-polyester

### Applications:

Stainless steel	●
Steel	●

**Advantages:** Long-life abrasive belt for a satin surface scratch pattern, under medium to high grinding pressure - Extremely long life, with consistent surface roughness and finish - Suitable for dry grinding

Available grits:

16 24 30 36 40 50 60 80 100 120 150 180 220 240 280 320 360 400 500 600 800 1000 1200 1500 2000

All sizes and minimum purchasing quantities available on request

Other grits and sizes available on request.

Please observe: Minimum order quantities for manufactured items see page 41. Please see Applications Guide on page 39-41, 80-83.

# Wide belts with cloth backing

Coated abrasives



Abrasive cloth, KULEX

## CS 329 Y



### Properties

Bonding agent	Resin
Grain	Al. oxide agglom.
Backing	Y-polyester

### Applications:

Stainless steel	●
Steel	●

**Advantages:** Long-life abrasive belt for a satin surface scratch pattern, under low to medium grinding pressure - Especially suitable for dry grinding

Available grits:

16 24 30 36 40 50 60 80 100 120 150 180 220 240 280 320 360 400 500 600 800 1000 1200 1500 2000

All sizes and minimum purchasing quantities available on request

Abrasive cloth

## CS 330 X



### Properties

Bonding agent	Resin
Grain	SiC/Cork
Coating	Close
Backing	X-cotton

### Applications:

Steel	●
Stainless steel	●

**Advantages:** Special product for soft and fine grinding, polishable due to very hard and sharp edged silicon carbide grit on cork granulate - Special satin finish grinding on steel and stainless steel surfaces - Suitable for dry and wet grinding

Available grits:

16 24 30 36 40 50 60 80 100 120 150 180 220 240 280 320 360 400 500 600 800 1000 1200 1500 2000

All sizes and minimum purchasing quantities available on request

Other grits and sizes available on request.

Please observe: Minimum order quantities for manufactured items see page 41. Please see Applications Guide on page 39-41, 80-83.

# Wide belts with cloth backing

Coated abrasives

Abrasive cloth ANTISTATIC

## CS 336 Y



### Properties

Bonding agent	Resin
Grain	SiC
Coating	Semi-open
Backing	Y-polyester

### Applications:

Wood	●
Mineral based materials	●
Wood based materials	●

**Advantages:** High removal rate, especially suitable for calibration and fine sanding of wood based materials (one piece wide belts up to 1620 mm) - Optimal static reduction - No dust accumulation due to perfect antistatic properties

Available grits:

16 24 30 36 40 50 60 80 100 120 150 180 220 240 280 320 360 400 500 600 800 1000 1200 1500 2000

All sizes and minimum purchasing quantities available on request

Abrasive cloth, waterproof

## CS 341 X



### Properties

Bonding agent	Resin
Grain	Aluminium oxide
Coating	Close
Backing	X-cotton

### Applications:

Metals	●
Stainless steel	●
Steel	●
NF metals	●

**Advantages:** Universal product for wet and dry grinding of steel and stainless steel - Excellent wear properties in wet grinding

Available grits:

16 24 30 36 40 50 60 80 100 120 150 180 220 240 280 320 360 400 500 600 800 1000 1200 1500 2000

All sizes and minimum purchasing quantities available on request

Other grits and sizes available on request.

Please observe: Minimum order quantities for manufactured items see page 41. Please see Applications Guide on page 39-41, 80-83.

# Wide belts with cloth backing

Coated abrasives



Abrasive cloth, multibond

## CS 409 Y



### Properties

Bonding agent	Resin
Grain	Zirconia alumina
Coating	Close
Backing	Y-polyester

### Applications:

Stainless steel	●
-----------------	---

**Advantages:** Aggressive abrasive behaviour due to self-sharpening zirconia alumina - Prevents heat tinting on stainless steel - Cool grinding due to additional multibond - Minimal clogging when used on aluminium and aluminium alloys

Available grits:

16 24 30 36 40 50 60 80 100 120 150 180 220 240 280 320 360 400 500 600 800 1000 1200 1500 2000

All sizes and minimum purchasing quantities available on request

Abrasive cloth, waterproof

## CS 411 Y



### Properties

Bonding agent	Resin
Grain	Zirconia alumina
Coating	Close
Backing	Y-polyester

### Applications:

Steel	●
Stainless steel	●
Metals	●

**Advantages:** Aggressive abrasive behaviour - Universal product for use on steel and stainless steel

Available grits:

16 24 30 36 40 50 60 80 100 120 150 180 220 240 280 320 360 400 500 600 800 1000 1200 1500 2000

All sizes and minimum purchasing quantities available on request

Other grits and sizes available on request.

Please observe: Minimum order quantities for manufactured items see page 41. Please see Applications Guide on page 39-41, 80-83.



# Wide belts with cloth backing

Coated abrasives

Abrasive cloth, waterproof

## CS 412 Y



### Properties

Bonding agent	Resin
Grain	Aluminium oxide
Coating	Close
Backing	Y-polyester

### Applications:

Stainless steel	●	Wood	①
Metals	●		
Steel	●		
NF metals	●		

**Advantages:** Universal product for rough and intermediate grinding of steel and non-ferrous metals

Available grits:

16 24 30 36 40 50 60 80 100 120 150 180 220 240 280 320 360 400 500 600 800 1000 1200 1500 2000

All sizes and minimum purchasing quantities available on request

Abrasive cloth ANTISTATIC

## CS 538 Z ACT



### Properties

Bonding agent	Resin
Grain	SiC
Coating	Close
Backing	Z-polyester

### Applications:

Wood based materials	●
Wood	●
Composite materials	●
Mineral based materials	●

**Advantages:** Exceptionally tear-resistant type of polyester - The perfectly balanced ACT recipe allows for a long service life combined with an excellent removal rate

Available grits:

16 24 30 36 40 50 60 80 100 120 150 180 220 240 280 320 360 400 500 600 800 1000 1200 1500 2000

All sizes and minimum purchasing quantities available on request

Other grits and sizes available on request.

Please observe: Minimum order quantities for manufactured items see page 41. Please see Applications Guide on page 39-41, 80-83.

# Wide belts with cloth backing

Coated abrasives



Abrasive cloth

## CS 912 Y ACT



### Properties

Bonding agent	Resin
Grain	Ceramic Al. oxide
Coating	Close
Backing	Y-polyester

### Applications:

Stainless steel	●
Steel	●

**Advantages:** Continuously aggressive abrasive behaviour due to micro-crystalline and self-sharpening ceramic grit - High performance abrasive belt for stainless steel finish grinding

### Available grits:

16 24 30 36 40 50 60 80 100 120 150 180 220 240 280 320 360 400 500 600 800 1000 1200 1500 2000

All sizes and minimum purchasing quantities available on request

Other grits and sizes available on request.

Please observe: Minimum order quantities for manufactured items see page 41. Please see Applications Guide on page 39-41, 80-83.



# Fibre discs

## About the product

Klingspor fibre discs have high material removal rates and service life, producing an optimal finish. Suitable backing plates complete the product range.

Areas of use are steel, stainless steel, non-ferrous metal and cast iron. The comprehensive grit range makes it possible to select the right tool for every application. Even the most difficult of surfaces can be worked on easily with the fibre discs.

Klingspor fibre discs are outstanding for rough grinding and sanding, de-rusting metal parts, deburring and grinding welded seams. These discs are also suitable for precision finishing work on metals.

The state-of-the-art laser cutting technology allows special shapes for specific applications.

## Quality and performance

- ▶ Low clogging rate
- ▶ Market leading service life
- ▶ Even grinding finish
- ▶ Cool grinding

Applications Fibre Discs

Application	Type	Grain	Backing	Coating	Characteristics	Page
Steel / NF metals	<b>CS 561</b>	Aluminium oxide	Fibre	●	Abrasive fibre disc for working on steel and NF metals	<b>102</b>
	<b>FS 764 ACT</b>	Aluminium oxide	Fibre	●	Abrasive fibre disc for processing steel and non-ferrous metals. High aggressiveness and long service life due to Advanced Coating Technology	<b>104</b>
Steel / Stainless steel	<b>CS 565</b>	Zirconia alumina	Fibre	●	Abrasive fibre disc with high stock removal rate for rough grinding and deburring of steel and stainless steel	<b>105</b>
	<b>FS 964 ACT</b>	Ceramic aluminium oxide	Fibre	●	Premium fibre disc with micro-crystalline, self-sharpening ceramic grit delivering superior aggressiveness and removal on construction steel and high alloy steels. Outstanding grit adhesion and service life thanks to Advanced Coating Technology	<b>107</b>
Stainless steel	<b>CS 570</b>	Zirconia alumina	Fibre	●	High performance fibre disc with additional multibond for high stock removal rate and long service life for cool grinding on stainless steel and high alloy steel, especially for surface grinding	<b>106</b>
	<b>FS 966 ACT</b>	Ceramic aluminium oxide	Fibre	●	High performance fibre disc with very high stock removal rate and extremely long service life, with self-sharpening ceramic grain for the processing of high alloy steel, multibond for cool grinding. Improved grit adhesion due to Advanced Coating Technology	<b>108</b>



● = close   ● = semi-open   ○ = open



# Fibre discs

Applications guide

## Technical information about the backing pad

The right backing pad		
<b>Product</b>	 <b>ST 358</b>	 <b>ST 358 A</b>
<b>Backing pad form</b>	Medium hard, flat	Hard, ribbed
<b>Benefit</b>	Even grinding finish, good adaptation to the workpiece	High material removal rates, high stability Additional benefit of our ribbed backing pad: increased aggression, cool grinding
<b>Application</b>	Finish grinding (grit 50 and finer), edge rounding, contour grinding, surface grinding	Rough grinding (up to grit 40 and coarser), chamfering, deburring work, welded seam work

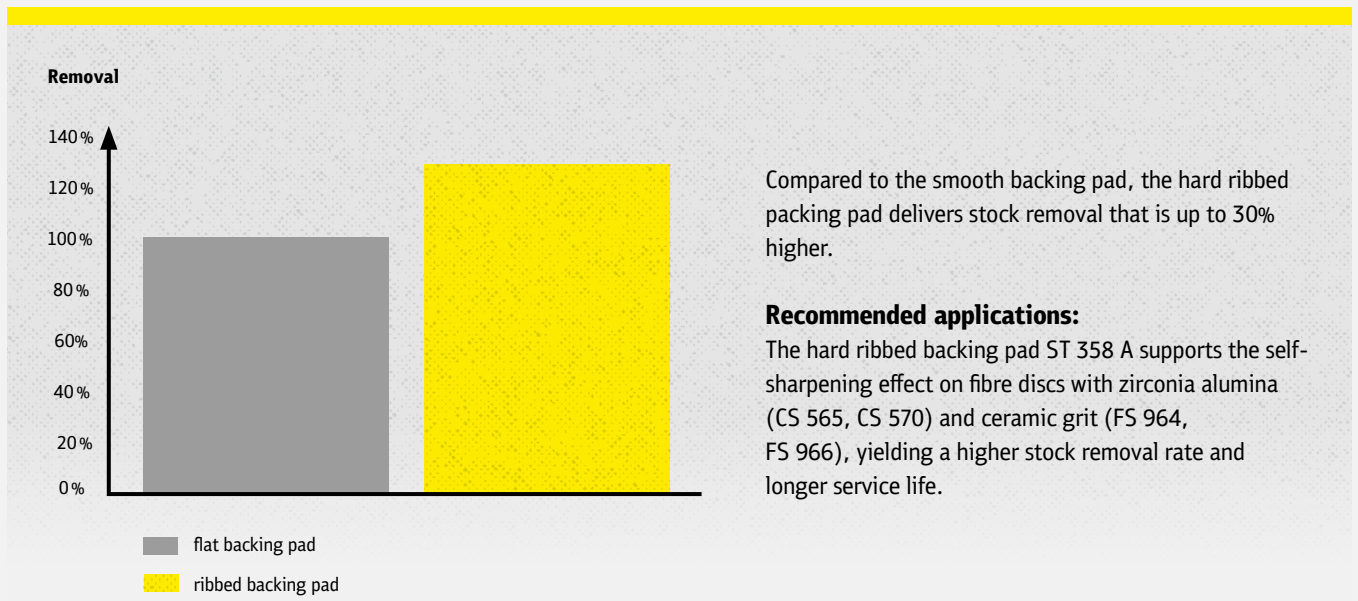

### The safe use of Klingspor abrasives

Klingspor fibre discs have been tested according to the guidelines of the oSa directives and are guaranteed to comply with European safety standard EN 12413

-  Wear safety goggles or glasses to protect the eyes
-  Wear safety gloves to protect hands
-  Wear a dust mask
-  Observe safety instructions
-  Use ear muffs
-  Do not use for wet grinding
-  Only permitted with a backing pad
-  Do not use if damaged

# Fibre discs

Applications guide



## Hole pattern for fibre discs



10 = round hole



30 = star-shaped hole

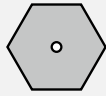

Additional special cutting shapes are available on request. Please ask for more information.



## Minimum order quantities for made to order items

Disc diameter	Minimum order quantities
up to 235 mm	1,000 pieces

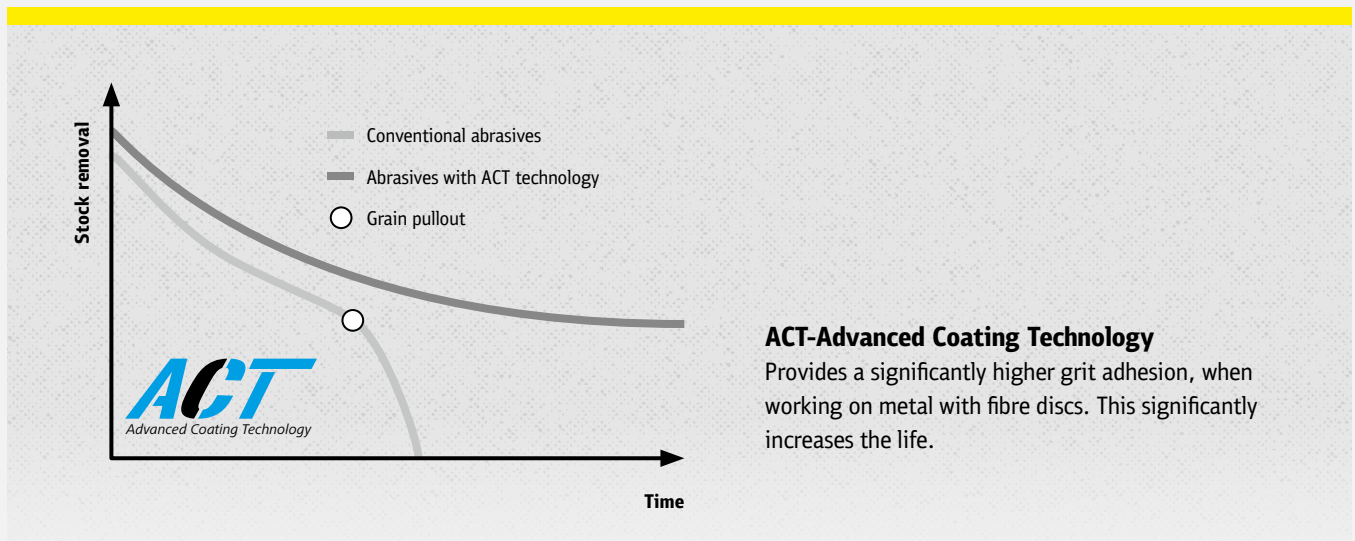



# Fibre discs

## Coated abrasives

Abrasive fibre disc

### CS 561



#### Properties

Bonding agent	Resin
Grain	Aluminium oxide
Coating	Close

#### Applications:

Steel	●	Stainless steel	⓪
NF metals	●	Wood	⓪
Metals	●		
Plastic	⓪		

**Advantages:** For universal use - Largest selection of diameters, grit sizes and hole patterns

#### Available grits:

16 24 30 36 40 50 60 80 100 120 150 180 220 240 280 320 360 400 500 600 800 1000 1200 1500 2000

Diameter x Hole in mm	Grit	Hole pattern	Packing unit/pcs.	Cat. number
100 x 16	16	⊙ 10	25	65708
100 x 16	24	⊙ 10	25	65713
100 x 16	36	⊙ 10	25	65718
100 x 16	40	⊙ 10	25	65720
100 x 16	50	⊙ 10	25	65725
100 x 16	60	⊙ 10	25	65730
100 x 16	80	⊙ 10	25	65735
100 x 16	100	⊙ 10	25	65739
100 x 16	120	⊙ 10	25	65743
115 x 22	16	⊙ 10	25	66302
115 x 22	24	⊙ 10	25	72298
115 x 22	36	⊙ 10	25	66308
115 x 22	40	⊙ 10	25	72192
115 x 22	50	⊙ 10	25	66313
115 x 22	60	⊙ 10	25	66318
115 x 22	80	⊙ 10	25	25472
115 x 22	100	⊙ 10	25	66322
115 x 22	120	⊙ 10	25	66327
115 x 22	16	⊛ 30	25	10977
115 x 22	24	⊛ 30	25	10978
115 x 22	30	⊛ 30	25	10979
115 x 22	36	⊛ 30	25	10980
115 x 22	40	⊛ 30	25	10981
115 x 22	50	⊛ 30	25	10982
115 x 22	60	⊛ 30	25	10983
115 x 22	80	⊛ 30	25	10984
115 x 22	100	⊛ 30	25	10985
115 x 22	120	⊛ 30	25	10986
115 x 22	150	⊛ 30	25	10987
115 x 22	180	⊛ 30	25	10988
115 x 22	220	⊛ 30	25	10989
115 x 22	240	⊛ 30	25	10990
115 x 22	320	⊛ 30	25	10992
125 x 22	16	⊙ 10	25	66354

Other grits and sizes available on request.

Please observe: Minimum order quantities for manufactured items see page 101. Please see Applications Guide on page 99-101.

Continuation →

# Fibre discs

## Coated abrasives



→ Continuation of CS 561, Abrasive fibre disc

Diameter x Hole in mm	Grit	Hole pattern	Packing unit/pcs.	Cat. number
125 x 22	24	⊙ 10	25	66358
125 x 22	36	⊙ 10	25	66364
125 x 22	40	⊙ 10	25	66366
125 x 22	50	⊙ 10	25	66371
125 x 22	60	⊙ 10	25	66376
125 x 22	80	⊙ 10	25	70439
125 x 22	100	⊙ 10	25	66379
125 x 22	120	⊙ 10	25	66383
125 x 22	16	⊗ 30	25	11009
125 x 22	24	⊗ 30	25	11010
125 x 22	30	⊗ 30	25	11011
125 x 22	36	⊗ 30	25	11012
125 x 22	40	⊗ 30	25	11013
125 x 22	50	⊗ 30	25	11014
125 x 22	60	⊗ 30	25	11015
125 x 22	80	⊗ 30	25	11016
125 x 22	100	⊗ 30	25	11017
125 x 22	120	⊗ 30	25	11018
125 x 22	150	⊗ 30	25	11019
125 x 22	180	⊗ 30	25	11020
125 x 22	220	⊗ 30	25	11021
125 x 22	240	⊗ 30	25	11022
125 x 22	320	⊗ 30	25	11024
150 x 22	24	⊗ 30	25	11042
150 x 22	36	⊗ 30	25	11044
150 x 22	40	⊗ 30	25	11045
150 x 22	60	⊗ 30	25	11047
150 x 22	80	⊗ 30	25	11048
150 x 22	120	⊗ 30	25	11050
180 x 22	16	⊙ 10	25	66443
180 x 22	24	⊙ 10	25	66451
180 x 22	36	⊙ 10	25	66459
180 x 22	40	⊙ 10	25	70447
180 x 22	50	⊙ 10	25	70448
180 x 22	60	⊙ 10	25	70449
180 x 22	80	⊙ 10	25	66465
180 x 22	100	⊙ 10	25	66469
180 x 22	120	⊙ 10	25	66472
180 x 22	16	⊗ 30	25	11057
180 x 22	24	⊗ 30	25	11058
180 x 22	36	⊗ 30	25	11060
180 x 22	40	⊗ 30	25	11061
180 x 22	50	⊗ 30	25	11062
180 x 22	60	⊗ 30	25	11063
180 x 22	80	⊗ 30	25	11064
180 x 22	100	⊗ 30	25	11065
180 x 22	120	⊗ 30	25	11066
180 x 22	180	⊗ 30	25	11068
180 x 22	240	⊗ 30	25	11070
180 x 22	320	⊗ 30	25	11072
235 x 22	24	⊙ 10	25	66497

Other grits and sizes available on request.

Continuation →

Please observe: Minimum order quantities for manufactured items see page 101. Please see Applications Guide on page 99-101.

# Fibre discs

## Coated abrasives

→ Continuation of CS 561, Abrasive fibre disc

Diameter x Hole in mm	Grit	Hole pattern	Packing unit/pcs.	Cat. number
235 x 22	36	⊙ 10	25	66502
235 x 22	40	⊙ 10	25	66504
235 x 22	60	⊙ 10	25	66511
235 x 22	80	⊙ 10	25	66514

Dispenser see page 110 / Backing pads see page 109

Abrasive fibre disc

## FS 764 ACT



### Properties

Bonding agent	Resin
Grain	Aluminium oxide
Coating	Close

### Applications:

Steel	●	NF metals	⓪
Stainless steel	●	Wood	⓪
Metals	●		
Plastic	⓪		

**Advantages:** For universal use - Increased removal rate and outstanding grit adhesion due to special ACT recipe - Long service life - Also suitable for stainless steel

Available grits:

16	24	30	36	40	50	60	80	100	120	150	180	220	240	280	320	360	400	500	600	800	1000	1200	1500	2000
----	----	----	----	----	----	----	----	-----	-----	-----	-----	-----	-----	-----	-----	-----	-----	-----	-----	-----	------	------	------	------

Diameter x Hole in mm	Grit	Hole pattern	Packing unit/pcs.	Cat. number
115 x 22	24	⊛ 30	25	316469
115 x 22	36	⊛ 30	25	316470
115 x 22	40	⊛ 30	25	316471
115 x 22	60	⊛ 30	25	316473
115 x 22	80	⊛ 30	25	316474
115 x 22	120	⊛ 30	25	316475
125 x 22	24	⊛ 30	25	316476
125 x 22	36	⊛ 30	25	316477
125 x 22	40	⊛ 30	25	316478
125 x 22	60	⊛ 30	25	316480
125 x 22	80	⊛ 30	25	316481
125 x 22	120	⊛ 30	25	316482
180 x 22	24	⊛ 30	25	316483
180 x 22	36	⊛ 30	25	316484
180 x 22	40	⊛ 30	25	316485
180 x 22	50	⊛ 30	25	316486
180 x 22	60	⊛ 30	25	316487
180 x 22	80	⊛ 30	25	316488
180 x 22	120	⊛ 30	25	316489

Dispenser see page 110 / Backing pads see page 109

Other grits and sizes available on request.

Please observe: Minimum order quantities for manufactured items see page 101. Please see Applications Guide on page 99-101.

Abrasive fibre disc

# CS 565



**Properties**

Bonding agent	Resin
Grain	Zirconia alumina
Coating	Close

**Applications:**

Stainless steel	●
Steel	●
Metals	●



**Advantages:** Self-sharpening effect - High aggressiveness on steel and stainless steel - Ideal for rough grinding work - Excellent price-performance ratio

**Available grits:**

16	24	30	36	40	50	60	80	100	120	150	180	220	240	280	320	360	400	500	600	800	1000	1200	1500	2000
----	----	----	----	----	----	----	----	-----	-----	-----	-----	-----	-----	-----	-----	-----	-----	-----	-----	-----	------	------	------	------

Diameter x Hole in mm	Grit	Hole pattern	Packing unit/pcs.	Cat. number
100 x 16	36	⊙ 10	25	23680
100 x 16	60	⊙ 10	25	84604
100 x 16	80	⊙ 10	25	188678
115 x 22	24	⊙ 10	25	93409
115 x 22	36	⊙ 10	25	65698
115 x 22	40	⊙ 10	25	242800
115 x 22	50	⊙ 10	25	85517
115 x 22	60	⊙ 10	25	65700
115 x 22	80	⊙ 10	25	65701
115 x 22	24	⊛ 30	25	95335
115 x 22	36	⊛ 30	25	6686
115 x 22	40	⊛ 30	25	242801
115 x 22	50	⊛ 30	25	92066
115 x 22	60	⊛ 30	25	6687
115 x 22	80	⊛ 30	25	6688
115 x 22	100	⊛ 30	25	204609
125 x 22	36	⊙ 10	25	65681
125 x 22	40	⊙ 10	25	242802
125 x 22	60	⊙ 10	25	65707
125 x 22	80	⊙ 10	25	23001
125 x 22	24	⊛ 30	25	97643
125 x 22	36	⊛ 30	25	6620
125 x 22	40	⊛ 30	25	242803
125 x 22	50	⊛ 30	25	93054
125 x 22	60	⊛ 30	25	6721
125 x 22	80	⊛ 30	25	23005
125 x 22	100	⊛ 30	25	204611
180 x 22	36	⊙ 10	25	65702
180 x 22	60	⊙ 10	25	65705
180 x 22	80	⊙ 10	25	65706
180 x 22	24	⊛ 30	25	95993
180 x 22	36	⊛ 30	25	65703

**Continuation →**

Other grits and sizes available on request.

Please observe: Minimum order quantities for manufactured items see page 101. Please see Applications Guide on page 99-101.

# Fibre discs

## Coated abrasives

→ Continuation of CS 565, Abrasive fibre disc

Diameter x Hole in mm	Grit	Hole pattern	Packing unit/pcs.	Cat. number
180 x 22	40	⊗ 30	25	242807
180 x 22	50	⊗ 30	25	93045
180 x 22	60	⊗ 30	25	6690
180 x 22	80	⊗ 30	25	6691

Dispenser see page 110 / Backing pads see page 109

Abrasive fibre disc, multibond

## CS 570



### Properties

Bonding agent	Resin
Grain	Zirconia alumina
Coating	Close

### Applications:

Stainless steel	●
Aluminium	●
NF metals	◐



**Advantages:** Self-sharpening effect - High aggressiveness, especially suitable for stainless steel - Increase in performance due to low temperatures - Multibond prevents heat tinting - Especially suitable for use on aluminium

Available grits:

16	24	30	36	40	50	60	80	100	120	150	180	220	240	280	320	360	400	500	600	800	1000	1200	1500	2000
----	----	----	----	----	----	----	----	-----	-----	-----	-----	-----	-----	-----	-----	-----	-----	-----	-----	-----	------	------	------	------

Diameter x Hole in mm	Grit	Hole pattern	Packing unit/pcs.	Cat. number
100 x 16	36	⊙ 10	25	204823
100 x 16	60	⊙ 10	25	204825
100 x 16	80	⊙ 10	25	204826
100 x 16	120	⊙ 10	25	204828
115 x 22	36	⊙ 10	25	204797
115 x 22	60	⊙ 10	25	204799
115 x 22	80	⊙ 10	25	204800
115 x 22	120	⊙ 10	25	204802
115 x 22	24	⊗ 30	25	204085
115 x 22	36	⊗ 30	25	204086
115 x 22	40	⊗ 30	25	250258
115 x 22	50	⊗ 30	25	204087
115 x 22	60	⊗ 30	25	204088
115 x 22	80	⊗ 30	25	204089
115 x 22	100	⊗ 30	25	204090
115 x 22	120	⊗ 30	25	204091
125 x 22	36	⊙ 10	25	204806
125 x 22	60	⊙ 10	25	204811
125 x 22	80	⊙ 10	25	204812
125 x 22	120	⊙ 10	25	204814
125 x 22	24	⊗ 30	25	204092
125 x 22	36	⊗ 30	25	204093
125 x 22	40	⊗ 30	25	250259
125 x 22	50	⊗ 30	25	204094
125 x 22	60	⊗ 30	25	204095
125 x 22	80	⊗ 30	25	204096

Other grits and sizes available on request.

Continuation →

Please observe: Minimum order quantities for manufactured items see page 101. Please see Applications Guide on page 99-101.

# Fibre discs

## Coated abrasives



→ Continuation of CS 570 ,Abrasive fibre disc, multibond

Diameter x Hole in mm	Grit	Hole pattern	Packing unit/pcs.	Cat. number
125 x 22	100	⊗ 30	25	204097
125 x 22	120	⊗ 30	25	204098
180 x 22	24	⊗ 30	25	204099
180 x 22	36	⊗ 30	25	204100
180 x 22	40	⊗ 30	25	250260
180 x 22	60	⊗ 30	25	204102
180 x 22	80	⊗ 30	25	204103
180 x 22	120	⊗ 30	25	204105

Dispenser see page 110 / Backing pads see page 109

Abrasive fibre disc

## FS 964 ACT



### Properties

Bonding agent Resin	
Grain	Ceramic Al. oxide
Coating	Close

### Applications:

Steel	●
Stainless steel	●

**Advantages:** Premium product with excellent performance for working on steel - Micro-crystalline self-sharpening effect - High aggressiveness thanks to self-sharpening, aggressive ceramic grains throughout the service life - Outstanding grit adhesion - Advanced coating technology (ACT) for extraordinary grain adhesion and extended service life

Available grits:

16	24	30	36	40	50	60	80	100	120	150	180	220	240	280	320	360	400	500	600	800	1000	1200	1500	2000
----	----	----	----	----	----	----	----	-----	-----	-----	-----	-----	-----	-----	-----	-----	-----	-----	-----	-----	------	------	------	------

Diameter x Hole in mm	Grit	Hole pattern	Packing unit/pcs.	Cat. number
115 x 22	24	⊗ 30	25	330478
115 x 22	36	⊗ 30	25	330498
115 x 22	40	⊗ 30	25	330482
115 x 22	50	⊗ 30	25	330480
115 x 22	60	⊗ 30	25	330479
115 x 22	80	⊗ 30	25	330481
115 x 22	120	⊗ 30	25	330483
125 x 22	24	⊗ 30	25	330484
125 x 22	36	⊗ 30	25	330485
125 x 22	40	⊗ 30	25	330486
125 x 22	50	⊗ 30	25	330488
125 x 22	60	⊗ 30	25	330487
125 x 22	80	⊗ 30	25	330490
125 x 22	120	⊗ 30	25	330491
180 x 22	24	⊗ 30	25	330489
180 x 22	36	⊗ 30	25	330492
180 x 22	40	⊗ 30	25	330493
180 x 22	50	⊗ 30	25	330494
180 x 22	60	⊗ 30	25	330495
180 x 22	80	⊗ 30	25	330496

Dispenser see page 110 / Backing pads see page 109

Other grits and sizes available on request.

Please observe: Minimum order quantities for manufactured items see page 101. Please see Applications Guide on page 99-101.



# Fibre discs

## Coated abrasives

Abrasive fibre disc, multibond

### FS 966 ACT



#### Properties

Bonding agent	Resin
Grain	Ceramic Al. oxide
Coating	Close

#### Applications:

Stainless steel	●
-----------------	---

**Advantages:** Micro-crystalline self-sharpening effect - High aggressiveness throughout the service life - Outstanding grit adhesion - Long service life, especially suitable for heavy duty applications - Increase in performance due to low temperatures - Multibond prevents heat tinting

#### Available grits:

16	24	30	36	40	50	60	80	100	120	150	180	220	240	280	320	360	400	500	600	800	1000	1200	1500	2000
----	----	----	----	----	----	----	----	-----	-----	-----	-----	-----	-----	-----	-----	-----	-----	-----	-----	-----	------	------	------	------

Diameter x Hole in mm	Grit	Hole pattern	Packing unit/pcs.	Cat. number
115 x 22	36	⊗ 30	25	316490
115 x 22	40	⊗ 30	25	316491
115 x 22	50	⊗ 30	25	318504
115 x 22	60	⊗ 30	25	316492
115 x 22	80	⊗ 30	25	316493
115 x 22	120	⊗ 30	25	324237
125 x 22	24	⊗ 30	25	318305
125 x 22	36	⊗ 30	25	316494
125 x 22	40	⊗ 30	25	316495
125 x 22	60	⊗ 30	25	316496
125 x 22	80	⊗ 30	25	316497
125 x 22	120	⊗ 30	25	324239
180 x 22	24	⊗ 30	25	318352
180 x 22	36	⊗ 30	25	316498
180 x 22	40	⊗ 30	25	316499
180 x 22	60	⊗ 30	25	316501
180 x 22	80	⊗ 30	25	316502
180 x 22	120	⊗ 30	25	324238

Dispenser see page 110 / Backing pads see page 109

Other grits and sizes available on request.

Please observe: Minimum order quantities for manufactured items see page 101. Please see Applications Guide on page 99-101.

Backing pad

## ST 358



**Advantages:** Medium-hard backing pad allows good adaptation to the workpiece - For universal use, especially for surface and finish grinding (grit 50 and finer) - High temperature resistance

Diameter in mm	Thread/Shaft	Suitable for	Max. operating speed	Max. RPM	Packing unit/pcs.	Cat. number
100	thread M10	Diameter 100 x 16	80 m/s	15300 rpm	1	305190
100	thread M14	Diameter 100 x 22	80 m/s	15300 rpm	1	2774
115	thread M10	Diameter 115 x 22	80 m/s	13300 rpm	1	14859
115	thread M14	Diameter 115 x 22	80 m/s	13300 rpm	1	14838
125	thread M14	Diameter 125 x 22	80 m/s	12200 rpm	1	14835
150	thread M14	Diameter 150 x 22	80 m/s	10200 rpm	1	14836
180	thread M14	Diameter 180 x 22	80 m/s	8500 rpm	1	14840
235	thread M14	Diameter 235 x 22	80 m/s	6600 rpm	1	14841

Backing pad

## ST 358 A



**Advantages:** For rough grinding - Cool grinding - Increased aggressiveness due to hard, ribbed abrasive surface - High temperature resistance and stability

Diameter in mm	Thread/Shaft	Suitable for	Max. operating speed	Max. RPM	Packing unit/pcs.	Cat. number
115	thread M14	Diameter 115 x 22	80 m/s	13300 rpm	1	126346
125	thread M14	Diameter 125 x 22	80 m/s	12200 rpm	1	126347
180	thread M14	Diameter 180 x 22	80 m/s	8500 rpm	1	126348

# Dispenser for fibre discs

Dispenser for fibre discs

## FS 555



**Advantages:** Easy stocking and removal of up to 100 fiber discs with diameter of 115 to 180 mm - Orderly and accessible storage at the workplace

**Fibre discs not included**

Width x Length x Height in mm	Packing unit/pcs.	Cat. number
170 x 140 x 196	1	316463



---

A large grid of small dots for taking notes.





# Strips/Sheets/Discs

## About the product

Klingspor manufactures a very large selection of high quality abrasive products for the strips, sheets and discs product sectors.

Application	Type	Grain	Backing	Coating	Characteristics	Page
Stainless steel	<b>NPA 400</b>	Aluminium oxide	Non-woven web		Grinding fleece, suited to deburring, cleaning and surface finishing	<b>135</b>
	<b>NDS 800</b>	Aluminium oxide	Non-woven web with polyester insert		Premium non-woven web disc with extra strong edges for demanding applications. Suited to rough cleaning work, deburring and working on weld seams	<b>161</b>
	<b>SV 484</b>	Aluminium oxide	Non-woven web with polyester insert		Standard non-woven web disc, superb value for money for finishing surfaces, slightly contoured surfaces	<b>160</b>
Steel / Stainless Steel	<b>PS 21 FK</b>	Zirconia alumina	F-paper	●	Premium self-fastening disc for finish grinding stainless steel and other metal surfaces using hand-operated machines. Ultra high level of aggressiveness and outstanding service life thanks to self-sharpening zirconia alumina. Exceptional stability and excellent edge strength on the perimeter thanks to strong F-paper backing	<b>143</b>
	<b>PS 61 FK</b>	Ceramic aluminium oxide	F-paper	●	Close coating, strong backing and micro-crystalline, self-sharpening ceramic grain provide an aggressive grinding behaviour on steel and stainless steel	<b>151</b>
	<b>NDS 400 K</b>	Aluminium oxide / SiC	Non-woven web		Non-woven disc for work on ultra-fine surfaces. The velour back lining makes the disc suitable for use on self-fastening backing pads.	<b>160</b>
Steel / Metals	<b>KL 361 JF</b>	Aluminium oxide	JF-cotton	●	High quality, highly flexible abrasive cloth for versatile applications in the metal processing industry, also suitable for stainless steel	<b>131, 134</b>
	<b>KL 371 X</b>	Aluminium oxide	X-cotton	●	Economical universal product for surface grinding in metal processing	<b>132</b>
	<b>KL 385 JF</b>	Aluminium oxide	JF-cotton	●	Highly flexible universal product for the metal processing industry, good price-performance ratio	<b>133</b>
	<b>CS 411 XK</b>	Zirconia alumina	X-cotton	●	Product for universal use during the processing of metal and stainless steel that offers a robust, tear-resistant cloth-reinforced backing, unrivalled versatility and a high level of aggressiveness and grinding performance during rough grinding applications on steel and stainless steel	<b>158</b>
Wood	<b>PS 22 F ACT</b>	Aluminium oxide	F-paper	●	Close coating for maximum stock removal and uniform scratch pattern regarding surface treatment of hard, low-content woods. Advanced Coating Technology (ACT) and antistatic properties prevent premature clogging	<b>124</b>
	<b>PS 22 K</b>	Aluminium oxide	E-paper	○	Abrasive paper with semi-open coating and exceptional machining performance to create a uniform scratch pattern when processing wood and metal	<b>126, 144, 145</b>
	<b>PS 30 D</b>	Aluminium oxide	D-paper	○	Economical abrasive paper for versatile applications in the processing of wood and paint	<b>121, 124</b>
	<b>PS 19 EK</b>	SiC	E-paper	●	Robust high performance product with stable E-paper backing for coarse, intermediate and finish sanding. Ideal for hard and difficult-to-machine materials due to the use of sharp-edged silicon carbide	<b>126, 143</b>
	<b>PL 31 B</b>	Aluminium oxide	B-paper	○	Flexible finishing paper with an optimal price-performance ratio for a wide range of applications for the processing of wood, paint and varnish. Provides a smooth surface finish	<b>121, 125</b>
Paint / Varnish / Filler	<b>PS 33 B</b>	Aluminium oxide	B-paper	○	High quality abrasive paper, especially suited for paint, varnish and filler	<b>123</b>
	<b>PS 33 BK</b>	Aluminium oxide	B-paper	○	High quality grinding disc for outstanding results - especially on paint, varnish and filler	<b>128, 150</b>
	<b>PS 33 C</b>	Aluminium oxide	C-paper	○	High quality abrasive paper, especially suited for paint, varnish and filler	<b>122</b>
	<b>PS 33 CK</b>	Aluminium oxide	C-paper	○	High quality grinding disc for outstanding results - especially on paint, varnish and filler	<b>127, 148, 149</b>
	<b>PS 73 BW</b>	Aluminium oxide	B-paper	○	High quality abrasive paper, especially suited for the processing of paint, varnish and filler, with a special coating for a long service life	<b>123</b>
	<b>PS 73 BWK</b>	Aluminium oxide	B-paper	○	High quality grinding disc for outstanding results - especially on paint, varnish and filler - with a long service life thanks to added active agent coating	<b>154</b>
	<b>PS 73 CWK</b>	Aluminium oxide	C-paper	○	High quality grinding disc for outstanding results - especially on paint, varnish and filler - with a long service life thanks to added active agent coating	<b>153</b>
	<b>PS 19 EK</b>	SiC	E-paper	●	Robust high performance product with stable F weight paper backing for coarse, intermediate and finish sanding. Ideal for hard and difficult-to-machine materials due to incredibly sharp silicon carbide grain	<b>126, 143</b>
	<b>FP 73 WK</b>	Aluminium oxide	Film	○	Special product with very tear resistant film backing for the processing of paint, varnish and filler with high service life through additional special coating	<b>129, 152</b>
	<b>PS 11 A</b>	SiC	A-paper	●	High quality, highly flexible, waterproof abrasive paper for working on paint, varnish and filler especially in the car repair sector	<b>120</b>
	<b>PS 11 C</b>	SiC	C-paper	●	High quality, highly flexible, waterproof abrasive paper for working on paint, varnish and filler especially in the car repair sector	<b>119, 142</b>
	<b>PS 8 A</b>	SiC	A-paper	●	Very flexible, waterproof abrasive paper for processing paint, varnish and filler predominantly in the sector of car repair and body paint	<b>118</b>
	<b>PS 8 C</b>	SiC	C-paper	●	Very flexible, waterproof abrasive paper for processing paint, varnish and filler predominantly in the sector of car repair and body paint	<b>118</b>

● = close ○ = semi-open ○ = open

### Paper

A	approx. 95 g/m <sup>2</sup>
B	approx. 105 g/m <sup>2</sup>
C	approx. 110 g/m <sup>2</sup>
D	approx. 130 g/m <sup>2</sup>
E	approx. 250 g/m <sup>2</sup>
F	approx. 300 g/m <sup>2</sup>

### Cloth

X	Cloth, heavy
J	Cloth, light
JF	Cloth, light, highly flexible

### Properties

K	Self-fastening
W	Coated with active agent

Continuation →



# Strips/Sheets/Discs

## Applications guide

Application	Type	Grain	Backing	Coating	Characteristics	Page
Paint / Varnish / Filler	<b>NPA 500</b>		Non-woven web		Grinding fleece, excellently suited to deburring, cleaning and surface finishing	<b>135</b>
	<b>FD 500</b>	Aluminium oxide / SiC	Foam core		Foam-coated disc for finish grinding. Superior flexibility and adaptability on contours and profiles	<b>156</b>
	<b>SK 500</b>	Aluminium oxide	Sponge	●	Abrasive block coated on four sides for fine work on contoured and flat surfaces. The abrasive block is robust, can be washed and reused. It is suitable for wet and dry grinding	<b>137</b>
	<b>SK 700 A</b>	Aluminium oxide	Sponge	●	Suitable for flat or upright use on all four sides; the angled edge (approx. 45°) makes it an exceptional choice for narrow, tapering workpiece contours. Excellent contouring and pressure distribution thanks to flexible foam core. Robust, washable and reusable	<b>137</b>
	<b>SW 501</b>	Aluminium oxide	Sponge	●	Highly flexible hand grinding tool. Abrasive sponge coated on two sides with plastic foam core. Resistant to creases and breaks, can be washed and reused. Suitable for dry and wet grinding	<b>138</b>
	<b>SW 502</b>	SiC	Sponge	●	Structure like SW 501, though with more aggressive SiC grit	<b>139</b>
	<b>SW 510</b>	Aluminium oxide	Sponge	●	Thin, ultra flexible sanding sponge for particularly hard-to-reach areas such as indentations, profiles and edges - Tight foam structure, allowing for exceptionally uniform pressure distribution and an extra fine finish - No bending, no creases - Can be used wet and dry	<b>138</b>
Paint / Varnish / Filler / Plastic	<b>SW 512</b>	SiC	Sponge	●	Structure like SW 510, but including sharp-edged silicon carbide grit	<b>139</b>
Composites, gel coats, paints and coatings, plaster and plaster- board, wood fillers and varnish	<b>AN 400</b>	Aluminium oxide	Abrasive screen	●	Effective high extraction dust removal thanks to open grid structure	<b>130, 155</b>

● = close ○ = semi-open ○ = open

## Strips/Sheets

- ▶ for general use for freehand grinding and sanding and for use with handheld power tools
- ▶ specially designed for particular materials (e.g. wood, metal, etc.)
- ▶ special sizes available on request
- ▶ for wet and dry grinding
- ▶ paper or cloth backed

## Discs

- ▶ for general use with many types of machines
- ▶ special designs with a wide range of hole patterns
- ▶ various sizes on customer's request
- ▶ for wet and dry grinding
- ▶ backings: paper, film and non-woven web
- ▶ self-fastening products
- ▶ suitable backing plate for angle grinder / orbital sander

## Hole patterns for strips

Klingspor offers a wide range of products with hole patterns for dust extraction. The hole pattern you require depends on the machine you are using. The chart alongside shows the most popular types of machines and the required hole pattern.

You will find the available hole patterns marked in the tables on the following product pages.

If the product you require is not in stock, we will manufacture it for you subject to a minimum order quantity.

**Other hole patterns available on request.**

	<b>GL 1</b>	115 × 280 mm 10 holes Ø 10 mm
	<b>GL 3</b>	93 × 230 mm 8 holes Ø 10 mm
	<b>GL 9</b>	93 × 230 mm 8 holes Ø 10 mm
	<b>GL 11</b>	115 × 280 mm 14 holes Ø 10 mm
	<b>GL 13</b>	115 × 280 mm 8 holes Ø 10 mm
	<b>GL 15</b>	115 × 230 mm 10 holes Ø 10 mm
	<b>GL 17</b>	93 × 180 mm 8 holes Ø 10 mm
	<b>GL 18</b>	80 × 133 mm 8 holes Ø 10 mm

## Minimum order quantities for made to order items

Product	Dimensions	Minimum order quantities
<b>Sheets</b>	230 × 280 mm	250 pieces
	70 × 450 mm	500 pieces
<b>Strips</b>	115 × 140 mm	1,000 pieces
	93 × 230 mm	500 pieces
	115 × 280 mm	500 pieces
<b>Sheets exceeding 230 x 280 mm</b>	Minimum quantities on request	
<b>Large sheets</b>	1400 × 1540 mm	10 pieces

Product	Dimensions	Minimum order quantities
<b>Self-fastening products</b>	70 × 125 mm	1,000 pieces
	80 × 133 mm	1,000 pieces
	93 × 230 mm	500 pieces
	100 × 115 mm	1,000 pieces
	115 × 280 mm	500 pieces

Other sizes available on request.

## Klingspor strips for every tool

Please contact Klingspor if you cannot find the machine used by you on this list. We will be pleased to assist you further.

Manufacturer	Type	Size in mm	Hole pattern	Design
<b>AEG powertools</b>	FS 2	80 × 133	GL 18	self-fastening
	VS/E 230, VSS/E 260	93 × 180	GL 17	self-fastening
	VSSE 260, VSS 260	93 × 230	GL 9	for clamping
	FDS 140	115 × 140	GL 38	for clamping
	FDS 140	115 × 140	GL 39	self-fastening
	VSS 20, VSSE 230, VS 280, VSE 280, VSSE 280	115 × 230	GL 16	self-fastening
	VSS 20, VSSE 20, VS 280, VSSE 280	115 × 280	plain	for clamping
	VSS/E 20, VS/E 280, VSSE 280	115 × 280	GL 11	for clamping
<b>Atlas Copco</b>	VS 11	80 × 133	GL 18	self-fastening
	VSS 20, VSSE 20	115 × 230	GL 16	self-fastening
	VSS 20, VSSE 20	115 × 280	GL 11	self-fastening
	LS030 H070-3, LS030 S070-3	93 × 180	plain	for clamping
	LS031 H070-3, LS031 S070-3, LS032 H070-3, LS032 S070-3	93 × 180	GL 3	for clamping
<b>Black &amp; Decker</b>	P 63-01	80 × 133	GL 18	self-fastening
	KA 330 EKA	90 × 190	GL 4	self-fastening
	KA 175, KA 186, KA 186 E	93 × 180	GL 17	self-fastening
	KA 320 EKA	93 × 190	GL 4	self-fastening
	KA 320 EKA, KA 300	93 × 230	GL 3	for clamping
	BD 175, BD 180 E, DN 41 AE, DN 180 E, KA 185, KA 185 E, KC 185 E	93 × 230	GL 9	for clamping
	KC 962, VB 135 A, CD 400, BN 41 AE	93 × 230	GL 9	for clamping
	KA 185, KA 185 E	93 × 230	plain	for clamping
	KA 273	115 × 230	GL 16	self-fastening
	P 63-03, P 63-04, P 63-05, BD 273, SR 410	115 × 280	plain	for clamping
	P 63-03, P 63-04, P 63-05, KA 273, SR 410 E, BD 273, DN 41, BD 175, BD 180E	115 × 280	GL 11	for clamping
	VB 135A, DN 180E, KA 185E, KC 962, DN 49, DN 273, VB 250 E, KA274EKA	115 × 280	GL 11	for clamping

Continuation →

# Strips/Sheets/Discs

## Applications guide

Manufacturer	Type	Size in mm	Hole pattern	Design
<b>Bosch</b>	PSS 240 A, PSS 240 AE, GSS 16 A	80 × 133	GL 18	self-fastening
	GSS 23 AE, GSS 230 A, GSS 230 AE, PSS 22, PSS 23, PSS 23 AE	93 × 180	GL 17	self-fastening
	PSS 23 A, PSS 180, PSS 240, PSS 180 A, PSS 240 A, PSS 240 AE	93 × 180	GL 17	self-fastening
	GSS 230 AVE Professional	93 × 185	GL 10	self-fastening
	PSS 250 AE, PSS 200 A	93 × 190	GL 10	self-fastening
	PSS 240 A, PSS 240 AE, GSS 23, GSS 23 AE, GSS 230 AE, GSS 230 AVE Professional	93 × 230	GL 9	for clamping
	PSS 22, PSS 23 A, PSS 230, PSS 23, PSS 23 AE, PSS 250 AE,	93 × 230	GL 9	for clamping
	GSS 23, GSS 23 AE, GSS 230 AE, PSS 22, PSS 23, PSS 23 A, PSS 23 AE, PSS 230	93 × 230	plain	for clamping
	GSS 140 A	115 × 107	GL 37	self-fastening
	1289 D	115 × 115	plain	self-fastening
	GSS 140 A	115 × 140	GL 38	for clamping
	GSS 28/A, GSS 280 A/AE, PSS 28 AE/280 AE, PSS 300 AE, GSS 280 AVE Professional	115 × 230	GL 16	self-fastening
	GSS 28, PSS 28 AE, PSS 280 AE, GSS 280 AE	115 × 280	plain	for clamping
	GSS 28, PSS 28 AE, PSS 280 AE, GSS 280 AE, PSS 300 AE, GSS 280 AVE Professional	115 × 280	GL 11	for clamping
<b>Casals</b>	KLR 210, VLR 210, BLR 170	93 × 180	GL 17	self-fastening
	BLR 250, VLR 300	115 × 230	GL 16	self-fastening
	LN 216, LR 228	115 × 280	plain	for clamping
<b>DeWalt, ELU</b>	D26423, D 26422	93 × 230	GL 3	self-fastening
	D26441	108 × 115	GL 20	self-fastening
	DW634, DW636, VS 41, VS 71	115 × 230	GL 16	self-fastening
	VS 71	115 × 280	plain	for clamping
	DW634, DW636, VS 41, VS 71	115 × 280	GL 1	for clamping
	D26420, D26421	115 × 280	GL 1	self-fastening
	D26441	140 × 115	GL 33	for clamping
<b>Einhell</b>	EST 170	93 × 180	GL 17	self-fastening
	BSS 150, BT-OS 150	93 × 230	GL 3	for clamping
	RT-OS 30, BT-OS 280 E	115 × 230	GL 15	self-fastening
	ERU 270	115 × 230	GL 16	self-fastening
	RT-OS 30, BT-OS 280 E	115 × 280	GL 1	for clamping
	SS-G 270, BSS 250	115 × 280	GL 13	for clamping
<b>Fein</b>	MSs 641 a, MSs 641 b	115 × 230	GL 16	self-fastening
	MSs 641 a, MSs 641 b	115 × 280	GL 11	for clamping
	MSs 641 a, MSs 641 b	115 × 280	GL 11	self-fastening
<b>Felisatti</b>	TP 31 E	80 × 133	GL 18	self-fastening
	TP 115/350 VE, TP 517/AS	115 × 280	plain	for clamping
<b>Festool</b>	RS 4, RS 4 E, RS 4 - STF, RS 4 E - STF, RS 400, RS 400 Plus, RTS 400 (EQ-Plus, EQ, Q-Plus, Q)	80 × 133	GL 18	self-fastening
	RS 3 - STF, RS 4 E - STF, RS 4, RS 4 E	80 × 165	GL 8	for clamping
	RS 3, RS 3 Plus, RS 3 E, RS 3 E Plus, RS 3 - STF, RS 3 E - STF, RS 300, RS 300 Q/EQ	93 × 180	GL 17	self-fastening
	RS 3 - SFE, RS 3 E - SFE, LRS 93	93 × 180	GL 17	self-fastening
	RS 3 - STF, RS 3 E - STF	93 × 230	plain	for clamping
	RS 3 - STF, RS 3 E - STF	93 × 230	GL 9	for clamping
	RS 1, RS 2, RS 2 E, LRB - IAS, RS 200, RS 100C, RS 100 CQ, RS 200 Q/EQ	115 × 230	GL 15	self-fastening
	RS 2 - STF, RS 2 E - STF, RS 1 - STF, RS 2, RS 2 E	115 × 230	GL 16	self-fastening
	RS 2 - STF, RS 2 E - STF, RS 1 - STF	115 × 280	plain	for clamping
	RS 2 - STF, RS 2 E - STF, RS 1 - STF	115 × 280	GL 11	for clamping
<b>Flex</b>	OS 80-2, OSE 80-2	80 × 133	GL 18	self-fastening
	MS 713	115 × 105	GL 43	self-fastening
<b>HILTI</b>	WFO 280	115 × 280	GL 1	for clamping
	WFO 280	115 × 230	GL 15	self-fastening

Continuation →

# Strips/Sheets/Discs

Applications guide



Manufacturer	Type	Size in mm	Hole pattern	Design
Hitachi	SV 8 SA	80 × 133	GL 18	self-fastening
	FS 10 SB	93 × 180	GL 17	self-fastening
	SV 12 SG	114 × 104	GL 19	self-fastening
	SV 12 SF	115 × 115	GL 20	self-fastening
	SV 12 SD, SV 12 V	115 × 230	GL 16	self-fastening
HOLZ HER	2436, 2437	93 × 180	GL 6	self-fastening
	2440	115 × 230	GL 15	self-fastening
	2441	115 × 230	GL 16	self-fastening
Kress	CRS 6165 A, CRS 6175 EA, 250 RSE Set, 300 RSE	115 × 230	GL 16	self-fastening
	CRS 6165 A, CRS 6175 EA, 250 RSE Set, 300 RSE	115 × 280	GL 11	for clamping
Mafell	UVA 115 E	115 × 230	GL 11	self-fastening
	U 115E, UK 115/ 115 E	115 × 230	GL 15	self-fastening
	U 115, U 115 E	115 × 230	GL 16	self-fastening
	U 115E, UK 115/ 115 E	115 × 280	GL 1	for clamping
Makita	BO 3700, BO 3711	93 × 230	GL 9	for clamping
	BO 4554, BO 4556, BO 4565, BO 4555, BO 4566	115 × 103	GL 19	self-fastening
	9045 B, 9045 N, 9046, BO 4900V	115 × 230	GL 16	self-fastening
	BO 4556, BO 4558, BO 4555	115 × 140	GL 38	for clamping
	BO 4901, 9046	115 × 280	plain	for clamping
	9046, BO 4900V	115 × 280	GL 11	for clamping
Metabo	SR 4350	93 × 180	GL 17	self-fastening
	SRE 4350 TURBOTEC	93 × 185	GL 10	self-fastening
	SR 221, SR 321, SR 4320, SFE 227, SF 226	93 × 230	plain	for clamping
	SR 226, SRE 227, SR 180 INTEC, SRE 4350 TURBOTEC	93 × 230	GL 9	for clamping
	SRE 357, SR 356, SR 10-23, SR 10-23 Intec, SR 20-23	93 × 230	plain	for clamping
	SR 216, SRE 217, SRA 60	115 × 115	GL 20	self-fastening
	FSR 200 INTEC	115 × 103	GL 19	self-fastening
	SR 358, SRE 359, SR 4351, SRE 4351 TURBOTEC	115 × 230	GL 16	self-fastening
	SR 328, SRE 329, SR 4321, SR 358, SRE 359	115 × 280	plain	for clamping
SR 328, SRE 329, SR 4321, SR 358, SRE 359, SRE 4351 TURBOTEC	115 × 280	GL 11	for clamping	
Milwaukee	POS 13	80 × 133	GL 18	self-fastening
Peugeot	PV 240 A, TV 4102	93 × 180	GL 17	self-fastening
	TV 4003, TV 4103	115 × 230	GL 16	self-fastening
Ryobi	ESS 2590	93 × 180	GL 17	self-fastening
	ESS 200 RS	93 × 185	GL 10	self-fastening
	ESS 1890 C	93 × 190	GL 10	self-fastening
	S 35, NS 40, NS 40 I, NS-801	93 × 230	plain	for clamping
	S 35, NS-40I, NS 801, NS 40, ESS 1890 C, ESS 2590, ESS 200 RS, ESS 280 RV	93 × 230	GL 9	for clamping
	EOS 2410	115 × 110	GL 29	self-fastening
	NS-6200, NS 6300 A, ESS 3215 V	115 × 230	GL 16	self-fastening
	NS 6300 A	115 × 280	plain	for clamping
ESS 3215 VHG	115 × 280	GL 11	for clamping	
SKIL	7300, 7300 S, 7330, 7390, 7395, 7365 AA	93 × 180	GL 17	self-fastening
	7366 AA, 7351 AA, 7346 AA, 7346, 7361 AB	93 × 190	GL 10	self-fastening
	7315, 7320, 7330, 7365 AA, 7366 AA, 7351 AA, 7346 AA, 7346, 7361 AB	93 × 230	GL 9	for clamping
	7314 MA	115 × 110	GL 29	self-fastening
	7312 AA, 7314 MA	115 × 140	GL 38	for clamping
	666, 7381 MA	115 × 230	GL 16	self-fastening
	7381 MA	115 × 280	GL 11	for clamping

# Sheets with paper backing

Coated abrasives

Abrasive paper, waterproof

## PS 8 C



### Properties

Bonding agent	Resin
Grain	SiC
Coating	Close
Backing	C-paper

### Applications:

Paint/Varnish/Filler	●
Plastic	●
Glass/Stone	◐
Metals	◐

**Advantages:** Ideal for hard and tough surfaces - Very flexible latex paper allows excellent adaptation - Can be used for wet and dry grinding

### Available grits:

16	24	30	36	40	50	60	80	100	120	150	180	220	240	280	320	360	400	500	600	800	1000	1200	1500	2000
----	----	----	----	----	----	----	----	-----	-----	-----	-----	-----	-----	-----	-----	-----	-----	-----	-----	-----	------	------	------	------

Width x Length in mm	Grit	Packing unit/pcs.	Cat. number
230 x 280	60	50	269424
230 x 280	80	50	269429
230 x 280	100	50	269435
230 x 280	120	50	269444
230 x 280	150	50	269448

Abrasive paper, waterproof

## PS 8 A



### Properties

Bonding agent	Resin
Grain	SiC
Coating	Close
Backing	A-paper

### Applications:

Paint/Varnish/Filler	●
Plastic	●
Glass/Stone	◐
Metals	◐

**Advantages:** Ideal for hard and tough surfaces - Very flexible latex paper allows excellent adaptation - Can be used for wet and dry grinding

### Available grits:

16	24	30	36	40	50	60	80	100	120	150	180	220	240	280	320	360	400	500	600	800	1000	1200	1500	2000	2500
----	----	----	----	----	----	----	----	-----	-----	-----	-----	-----	-----	-----	-----	-----	-----	-----	-----	-----	------	------	------	------	------

Width x Length in mm	Grit	Packing unit/pcs.	Cat. number
230 x 280	180	50	269269
230 x 280	220	50	269275
230 x 280	240	50	269279
230 x 280	280	50	269285
230 x 280	320	50	269289
230 x 280	360	50	269294

Continuation →

Other grits and sizes available on request.

Please observe: Minimum order quantities for manufactured items see page 115. Please see Applications Guide on page 113-117.

# Sheets with paper backing

Coated abrasives



→ Continuation of PS 8 A, Abrasive paper, waterproof

Width x Length in mm	Grit	Packing unit/pcs.	Cat. number
230 x 280	400	50	269299
230 x 280	600	50	269314
230 x 280	800	50	269323
230 x 280	1000	50	269328

Abrasive paper, waterproof

## PS 11 C



### Properties

Bonding agent	Resin
Grain	SiC
Coating	Close
Backing	C-paper

### Applications:

Paint/Varnish/Filler	●
Plastic	●
Glass/Stone	⦿
Metals	⦿

**Advantages:** Special product for auto repair and painting - For hard and tough surfaces - Good adaptation and high stability - Wet and dry sanding

Available grits:

16	24	30	36	40	50	60	80	100	120	150	180	220	240	280	320	360	400	500	600	800	1000	1200	1500	2000
----	----	----	----	----	----	----	----	-----	-----	-----	-----	-----	-----	-----	-----	-----	-----	-----	-----	-----	------	------	------	------

Width x Length in mm	Grit	Packing unit/pcs.	Cat. number
230 x 280	60	50	2022
230 x 280	80	50	2023
230 x 280	100	50	2117
230 x 280	120	50	2116
230 x 280	150	50	2011
230 x 280	180	50	2012
230 x 280	220	50	2013
230 x 280	240	50	2014
230 x 280	280	50	2015
230 x 280	320	50	2016
230 x 280	360	50	2017
230 x 280	400	50	2018

Other grits and sizes available on request.

Please observe: Minimum order quantities for manufactured items see page 115. Please see Applications Guide on page 113-117.



# Sheets with paper backing

Coated abrasives

Abrasive paper, waterproof

## PS 11 A



### Properties

Bonding agent	Resin
Grain	SiC
Coating	Close
Backing	A-paper

### Applications:

Paint/Varnish/Filler	●
Plastic	●
Glass/Stone	◐
Metals	◑

**Advantages:** Special product for auto repair and painting - For hard and tough surfaces - Good adaptation and high stability - Wet and dry sanding

### Available grits:

16 24 30 36 40 50 60 80 100 120 150 180 220 240 280 320 360 400 500 600 800 1000 1200 1500 2000

Width x Length in mm	Grit	Packing unit/pcs.	Cat. number
230 x 280	220	50	2002
230 x 280	240	50	2003
230 x 280	280	50	2004
230 x 280	320	50	2005
230 x 280	360	50	2006
230 x 280	400	50	2007
230 x 280	500	50	2008
230 x 280	600	50	2009
230 x 280	800	50	2010
230 x 280	1000	50	11892
230 x 280	1200	50	6616
230 x 280	1500	50	186794
230 x 280	2000	50	186795

Other grits and sizes available on request.

Please observe: Minimum order quantities for manufactured items see page 115. Please see Applications Guide on page 113-117.

# Sheets with paper backing

Coated abrasives



Abrasive paper

## PS 30 D



### Properties

Bonding agent	Resin
Grain	Aluminium oxide
Coating	Semi-open
Backing	D-paper

### Applications:

Paint/Varnish/Filler	●
Wood	●
Metals	⓪

**Advantages:** Product with good price-performance ratio - For diverse applications

Available grits:

16 24 30 36 40 50 60 80 100 120 150 180 220 240 280 320 360 400 500 600 800 1000 1200 1500 2000

Width x Length in mm	Grit	Packing unit/pcs.	Cat. number
230 x 280	40	50	194660
230 x 280	60	50	194662
230 x 280	80	50	194663
230 x 280	100	50	194664
230 x 280	120	50	194665
230 x 280	150	50	194666
230 x 280	180	50	194667
230 x 280	240	50	194668
230 x 280	320	50	194669

Finishing paper

## PL 31 B



### Properties

Bonding agent	Glue
Grain	Aluminium oxide
Coating	Semi-open
Backing	B-paper

### Applications:

Paint/Varnish/Filler	●
Wood	●
Metals	⓪

**Advantages:** Product with optimal price-performance ratio - Optimized wear properties for hand grinding - Very fine surface scratch pattern

Available grits:

16 24 30 36 40 50 60 80 100 120 150 180 220 240 280 320 360 400 500 600 800 1000 1200 1500 2000

Width x Length in mm	Grit	Packing unit/pcs.	Cat. number
230 x 280	40	50	2059
230 x 280	50	50	2060
230 x 280	60	50	2061
230 x 280	80	50	2062

Other grits and sizes available on request.

Please observe: Minimum order quantities for manufactured items see page 115. Please see Applications Guide on page 113-117.

Continuation →

# Sheets with paper backing

Coated abrasives

→ Continuation of PL 31 B, Finishing paper

Width x Length in mm	Grit	Packing unit/pcs.	Cat. number
230 x 280	100	50	2048
230 x 280	120	50	2049
230 x 280	150	50	2050
230 x 280	180	50	2051
230 x 280	220	50	2052
230 x 280	240	50	2053
230 x 280	280	50	2054
230 x 280	320	50	2055
230 x 280	400	50	2057

Abrasive paper

## PS 33 C



### Properties

Bonding agent	Resin
Grain	Aluminium oxide
Coating	Semi-open
Backing	C-paper

### Applications:

Paint/Varnish/Filler	●
Wood	●
Plastic	○

**Advantages:** High removal rate - For diverse applications

Available grits:

16 24 30 36 40 50 60 80 100 120 150 180 220 240 280 320 360 400 500 600 800 1000 1200 1500 2000

Width x Length in mm	Grit	Packing unit/pcs.	Cat. number
230 x 280	40	50	147849
230 x 280	60	50	147850
230 x 280	80	50	147851
230 x 280	100	50	149719
230 x 280	120	50	147852

Other grits and sizes available on request.

Please observe: Minimum order quantities for manufactured items see page 115. Please see Applications Guide on page 113-117.

# Sheets with paper backing

Coated abrasives



Abrasive paper

## PS 33 B



### Properties

Bonding agent	Resin
Grain	Aluminium oxide
Coating	Semi-open
Backing	B-paper

### Applications:

Paint/Varnish/Filler	●
Wood	●
Plastic	○

**Advantages:** High removal rate - For diverse applications

Available grits:

16 24 30 36 40 50 60 80 100 120 150 180 220 240 280 320 360 400 500 600 800 1000 1200 1500 2000

Width x Length in mm	Grit	Packing unit/pcs.	Cat. number
230 x 280	150	50	149528
230 x 280	180	50	147853
230 x 280	220	50	149529
230 x 280	240	50	147854
230 x 280	280	50	149793
230 x 280	320	50	149530
230 x 280	400	50	148971
230 x 280	500	50	170667
230 x 280	600	50	170668

Abrasive paper, actively coated

## PS 73 BW



### Properties

Bonding agent	Resin
Grain	Aluminium oxide
Coating	Semi-open
Backing	B-paper

### Applications:

Paint/Varnish/Filler	●
Plastic	●

**Advantages:** High quality product for use on varnish, paint and filler - High removal rate - Substantially reduced clogging and significantly longer service life due to additional special coating

Available grits:

16 24 30 36 40 50 60 80 100 120 150 180 220 240 280 320 360 400 500 600 800 1000 1200 1500 2000

All sizes and minimum purchasing quantities available on request

Other grits and sizes available on request.

Please observe: Minimum order quantities for manufactured items see page 115. Please see Applications Guide on page 113-117.

# Strips with paper backing

Coated abrasives

Abrasive paper, ANTISTATIC

## PS 22 F ACT



### Properties

Bonding agent	Resin
Grain	Aluminium oxide
Coating	Close
Backing	F-paper

### Applications:

Wood	●	Steel	○
Metals	○	NF metals	○
Paint/Varnish/Filler	○		
Plastic	○		

**Advantages:** Premium product for hardwood - Good edge stability - Reduced clogging due to ACT recipe and antistatic properties

Available grits:

16 24 30 36 40 50 60 80 100 120 150 180 220 240 280 320 360 400 500 600 800 1000 1200 1500 2000

Width x Length in mm	Grit	Packing unit/pcs.	Cat. number
115 x 280	40	100	6529
115 x 280	60	100	6531
115 x 280	80	100	6532
115 x 280	100	100	6533

Abrasive paper

## PS 30 D



### Properties

Bonding agent	Resin
Grain	Aluminium oxide
Coating	Semi-open
Backing	D-paper

### Applications:

Paint/Varnish/Filler	●
Wood	●
Metals	○

**Advantages:** Product with good price-performance ratio - For diverse applications

Available grits:

16 24 30 36 40 50 60 80 100 120 150 180 220 240 280 320 360 400 500 600 800 1000 1200 1500 2000

Width x Length in mm	Grit	Packing unit/pcs.	Cat. number
115 x 280	60	100	194673
115 x 280	80	100	194674
115 x 280	120	100	194676
115 x 280	180	100	194679
115 x 280	240	100	194680

Other grits and sizes available on request.

Please observe: Minimum order quantities for manufactured items see page 115. Please see Applications Guide on page 113-117.

# Strips with paper backing

Coated abrasives



Finishing paper

## PL 31 B



### Properties

Bonding agent	Glue
Grain	Aluminium oxide
Coating	Semi-open
Backing	B-paper

### Applications:

Paint/Varnish/Filler	●
Wood	●
Metals	○

**Advantages:** Product with optimal price-performance ratio - Optimized wear properties for hand-held machine grinding - Very fine surface scratch pattern

### Available grits:

16 24 30 36 40 50 60 80 100 120 150 180 220 240 280 320 360 400 500 600 800 1000 1200 1500 2000

Width x Length in mm	Grit	Hole pattern	Packing unit/pcs.	Cat. number
93 x 230	40		100	2416
93 x 230	60		100	2418
93 x 230	80		100	2419
93 x 230	100		100	2390
93 x 230	120		100	2391
93 x 230	180		100	2393
93 x 230	240		100	2395
93 x 230	40	GL 9	100	2665
93 x 230	60	GL 9	100	2667
93 x 230	80	GL 9	100	2668
93 x 230	120	GL 9	100	2670
93 x 230	180	GL 9	100	2684
115 x 280	40		100	2412
115 x 280	60		100	2414
115 x 280	80		100	2415
115 x 280	100		100	2379
115 x 280	120		100	2380
115 x 280	150		100	2381
115 x 280	180		100	2382
115 x 280	220		100	2383
115 x 280	240		100	2384
115 x 280	60	GL 1	100	5324
115 x 280	80	GL 1	100	5323
115 x 280	120	GL 1	100	5321

Other grits and sizes available on request.

Please observe: Minimum order quantities for manufactured items see page 115. Please see Applications Guide on page 113-117.



# Strips with paper backing, self-fastening

Coated abrasives

Abrasive paper, self-fastening

## PS 19 EK



### Properties

Bonding agent	Resin
Grain	SiC
Coating	Close
Backing	E-paper

### Applications:

Wood	●
Paint/Varnish/Filler	●
Plastic	●
Glass/Stone	●

**Advantages:** Hard and sharp silicon carbide grain for hard and tough materials - Resistant high-performance product with a stable E-paper backing for rough, intermediate and finish sanding

Available grits:

16 24 30 36 40 50 60 80 100 120 150 180 220 240 280 320 360 400 500 600 800 1000 1200 1500 2000

All sizes and minimum purchasing quantities available on request

Abrasive paper, self-fastening

## PS 22 K



### Properties

Bonding agent	Resin
Grain	Aluminium oxide
Coating	Semi-open
Backing	E-paper

### Applications:

Wood	●	Steel	⦿
Metals	●		
Paint/Varnish/Filler	⦿		
Plastic	⦿		

**Advantages:** High removal rate - Uniform scratch pattern

Available grits:

16 24 30 36 40 50 60 80 100 120 150 180 220 240 280 320 360 400 500 600 800 1000 1200 1500 2000

Width x Length in mm	Grit	Hole pattern	Packing unit/pcs.	Cat. number
70 x 125	60		100	147593
70 x 125	80		100	140608
70 x 125	100		100	131668
70 x 125	120		100	129801
70 x 125	150		100	135581
70 x 125	180		100	129802
80 x 133	40	GL 18	100	149852
80 x 133	60	GL 18	100	149853
80 x 133	80	GL 18	100	149854
80 x 133	100	GL 18	100	149855
80 x 133	120	GL 18	100	149857
80 x 133	150	GL 18	100	232741
80 x 133	180	GL 18	100	232742

Other grits and sizes available on request.

Continuation →

Please observe: Minimum order quantities for manufactured items see page 115. Please see Applications Guide on page 113-117.

# Strips with paper backing, self-fastening

Coated abrasives



→ Continuation of PS 22 K, Abrasive paper, self-fastening

Width x Length in mm	Grit	Hole pattern	Packing unit/pcs.	Cat. number
80 x 133	220	GL 18	100	206371
100 x 115	80		100	103378
100 x 115	100		100	103379
100 x 115	120		100	103380
100 x 115	150		100	103381
115 x 115	80		100	82076
115 x 115	120		100	81637
115 x 115	150		100	94721
115 x 230	40	GL 15	100	122331
115 x 230	60	GL 15	100	116647
115 x 230	80	GL 15	100	116648
115 x 230	100	GL 15	100	116649
115 x 230	120	GL 15	100	114942
115 x 230	150	GL 15	100	111500

Abrasive paper, self-fastening

## PS 33 CK



### Properties

Bonding agent	Resin
Grain	Aluminium oxide
Coating	Semi-open
Backing	C-paper

### Applications:

Paint/Varnish/Filler	●
Wood	●
Plastic	⓪

**Advantages:** High removal rate - For diverse applications

Available grits:

16	24	30	36	40	50	60	80	100	120	150	180	220	240	280	320	360	400	500	600	800	1000	1200	1500	2000
----	----	----	----	----	----	----	----	-----	-----	-----	-----	-----	-----	-----	-----	-----	-----	-----	-----	-----	------	------	------	------

Width x Length in mm	Grit	Hole pattern	Packing unit/pcs.	Cat. number
70 x 125	80		100	155072
70 x 125	100		100	151786
70 x 125	120		100	151785
80 x 133	40	GL 18	100	146974
80 x 133	60	GL 18	100	146975
80 x 133	80	GL 18	100	146976
80 x 133	100	GL 18	100	146977
80 x 133	120	GL 18	100	147169
93 x 178	40	GL 17	100	146970
93 x 178	60	GL 17	100	146971
93 x 178	80	GL 17	100	146972
93 x 178	100	GL 17	100	146973
93 x 178	120	GL 17	100	148046
100 x 115	80		100	147101
100 x 115	100		100	147102
100 x 115	120		100	147103

Other grits and sizes available on request.





Continuation →

Please observe: Minimum order quantities for manufactured items see page 115. Please see Applications Guide on page 113-117.

# Strips with paper backing, self-fastening

Coated abrasives

→ Continuation of PS 33 CK, Abrasive paper, self-fastening

Width x Length in mm	Grit	Hole pattern	Packing unit/pcs.	Cat. number
115 x 230	40	 GL 15	100	146966
115 x 230	60	 GL 15	100	146967
115 x 230	80	 GL 15	100	146968
115 x 230	100	 GL 15	100	146969
115 x 230	120	 GL 15	100	147182

Abrasive paper, self-fastening

## PS 33 BK



### Properties

Bonding agent	Resin
Grain	Aluminium oxide
Coating	Semi-open
Backing	B-paper















### Applications:

Paint/Varnish/Filler	●
Wood	●
Plastic	◐

**Advantages:** High removal rate - For diverse applications

Available grits:

16 24 30 36 40 50 60 80 100 120 150 180 220 240 280 320 360 400 500 600 800 1000 1200 1500 2000

Width x Length in mm	Grit	Hole pattern	Packing unit/pcs.	Cat. number
70 x 125	150		100	151784
70 x 125	180		100	148228
70 x 125	220		100	155500
70 x 125	240		100	152381
70 x 125	280		100	197133
80 x 133	150	 GL 18	100	149107
80 x 133	180	 GL 18	100	147479
80 x 133	220	 GL 18	100	149819
80 x 133	240	 GL 18	100	148050
80 x 133	320	 GL 18	100	149897
80 x 133	400	 GL 18	100	149899
93 x 178	150	 GL 17	100	149138
93 x 178	180	 GL 17	100	148047
93 x 178	240	 GL 17	100	148048
100 x 115	150		100	148658
100 x 115	180		100	147104
100 x 115	240		100	147105
115 x 230	150	 GL 15	100	149820
115 x 230	180	 GL 15	100	147183
115 x 230	220	 GL 15	100	149486
115 x 230	240	 GL 15	100	147184
115 x 230	320	 GL 15	100	147185

Other grits and sizes available on request.

Please observe: Minimum order quantities for manufactured items see page 115. Please see Applications Guide on page 113-117.

# Strips with film backing, self-fastening

Coated abrasives



Abrasive film, active coated, self fastening

## FP 73 WK



### Properties

Bonding agent	Resin
Grain	Aluminium oxide
Coating	Semi-open
Backing	Film

### Applications:

Paint/Varnish/Filler	●
Plastic	⓪

**Advantages:** Special product with highly tear-resistant film backing for use on paint, varnish and fillers - Very good adaptation and excellent grit adhesion also in the edge area - Substantially reduced clogging and significantly longer service life

### Available grits:

16 24 30 36 40 50 60 80 100 120 150 180 220 240 280 320 360 400 500 600 800 1000 1200 1500 2000

All sizes and minimum purchasing quantities available on request

Self-fastening support

## CS 396 Y



### Properties

Engaging elements	Mushroom heads
Thickness	1,5 mm
Temperature range	-30° to +80°

**Advantages:** Can be cut to size easily - Simple and safe fixing on smooth and even surfaces - Allows a quick change of the abrasive

All sizes and minimum purchasing quantities available on request

Other grits and sizes available on request.

Please observe: Minimum order quantities for manufactured items see page 115. Please see Applications Guide on page 113-117.

# Abrasive screen, self-fastening / Hand block

Abrasive screen, self-fastening, waterproof

## AN 400



### Properties

Bonding agent	Resin
Grain	Aluminium oxide
Backing	Polyester screen

### Applications:

Paint/Varnish/Filler	●	Composite materials	●
Gel coats	●	Wood	●
Plaster	●	Wood based materials	●
Plasterboard walls	●		

**Advantages:** Effective and full-surface dust extraction thanks to open grid structure - Dust-free grinding extends the service life of the abrasive - At the same time, improved health and safety thanks to reduced dust formation at the work station - Independent of existing extraction hole patterns - Waterproof

### Available grits:

16	24	30	36	40	50	60	80	100	120	150	180	220	240	280	320	360	400	500	600	800	1000	1200	1500	2000
Width x Length in mm		Grit	Packing unit/pcs.	Cat. number																				
80 x 133		80	50	337892																				
80 x 133		100	50	337891																				
80 x 133		120	50	337890																				
80 x 133		150	50	337894																				
80 x 133		180	50	337889																				
80 x 133		240	50	337893																				
80 x 133		320	50	337895																				
80 x 133		400	50	337896																				

Hand block

## HK 100



**Advantages:** Excellent for flat and slightly convex surfaces - Fatigue-proof hand grinding due to ergonomic form - For strips in 70 x 125 mm

Width x Length x Height in mm	Packing unit/pcs.	Cat. number
68 x 118 x 40	1	185320

Other grits and sizes available on request.

Please observe: Please see Applications Guide on page 113-117.

# Sheets with cloth backing

Coated abrasives



Abrasive cloth, brown

## KL 361 JF



### Properties

Bonding agent	Resin
Grain	Aluminium oxide
Coating	Close
Backing	JF-cotton

### Applications:

Steel	●	Stainless steel	●
Metals	●	Plastic	○
NF metals	●		
Wood	●		

**Advantages:** High-quality universal product - Optimal adaptation to the workpiece due to highly flexible cotton backing - Tears off cleanly and easily

### Available grits:

16 24 30 36 40 50 60 80 100 120 150 180 220 240 280 320 360 400 500 600 800 1000 1200 1500 2000

Width x Length in mm	Grit	Packing unit/pcs.	Cat. number
230 x 280	30	50	2083
230 x 280	40	50	2084
230 x 280	50	50	2085
230 x 280	60	50	2086
230 x 280	80	50	2087
230 x 280	100	50	2088
230 x 280	120	50	2089
230 x 280	150	50	2090
230 x 280	180	50	2091
230 x 280	220	50	2092
230 x 280	240	50	2093
230 x 280	280	50	2094
230 x 280	320	50	2095
230 x 280	360	50	2096
230 x 280	400	50	2097
230 x 280	500	50	2098
230 x 280	600	50	5334

Other grits and sizes available on request.

Please observe: Minimum order quantities for manufactured items see page 115. Please see Applications Guide on page 113-117.



# Sheets with cloth backing

Coated abrasives

Abrasive cloth, blue

## KL 371 X



### Properties

Bonding agent	Glue
Grain	Aluminium oxide
Coating	Close
Backing	X-cotton

### Applications:

Metals	●
NF metals	●

**Advantages:** Attractively priced universal product for surface hand grinding

### Available grits:

16	24	30	36	40	50	60	80	100	120	150	180	220	240	280	320	360	400	500	600	800	1000	1200	1500	2000
----	----	----	----	----	----	----	----	-----	-----	-----	-----	-----	-----	-----	-----	-----	-----	-----	-----	-----	------	------	------	------

Width x Length in mm	Grit	Packing unit/pcs.	Cat. number
230 x 280	40	50	2100
230 x 280	50	50	2101
230 x 280	60	50	2102
230 x 280	80	50	2103
230 x 280	100	50	2104
230 x 280	120	50	2105
230 x 280	150	50	2106
230 x 280	180	50	2107
230 x 280	220	50	2108
230 x 280	240	50	2109
230 x 280	280	50	119885
230 x 280	320	50	119886
230 x 280	400	50	119888

Other grits and sizes available on request.

Please observe: Minimum order quantities for manufactured items see page 115. Please see Applications Guide on page 113-117.

# Sheets with cloth backing

Coated abrasives



Abrasive cloth, brown

## KL 385 JF



### Properties

Bonding agent	Resin
Grain	Aluminium oxide
Coating	Close
Backing	JF-cotton

### Applications:

Wood	●
Metals	●
NF metals	●
Stainless steel	⦿

Plastic	⦿
---------	---

**Advantages:** Attractively priced universal product for profile grinding - Optimal adaptation to the workpiece due to highly flexible cotton backing - Tears off cleanly and easily

### Available grits:

16 24 30 36 40 50 60 80 100 120 150 180 220 240 280 320 360 400 500 600 800 1000 1200 1500 2000

Width x Length in mm	Grit	Packing unit/pcs.	Cat. number
230 x 280	40	50	218047
230 x 280	60	50	218050
230 x 280	80	50	218051
230 x 280	100	50	218052
230 x 280	120	50	218053
230 x 280	150	50	218054
230 x 280	180	50	218055
230 x 280	220	50	218056
230 x 280	240	50	218057
230 x 280	280	50	218058
230 x 280	320	50	218059
230 x 280	400	50	218061
230 x 280	600	50	218063

Other grits and sizes available on request.

Please observe: Minimum order quantities for manufactured items see page 115. Please see Applications Guide on page 113-117.

# Strips with cloth backing

Coated abrasives

Abrasive cloth, brown

## KL 361 JF



### Properties

Bonding agent	Resin
Grain	Aluminium oxide
Coating	Close
Backing	JF-cotton

### Applications:

Steel	●	Stainless steel	●
Metals	●	Plastic	⊖
NF metals	●		
Wood	●		

**Advantages:** High-quality universal product - Optimal adaptation to the workpiece due to highly flexible cotton backing - Tears off cleanly and easily

### Available grits:

16 24 30 36 40 50 60 80 100 120 150 180 220 240 280 320 360 400 500 600 800 1000 1200 1500 2000

Width x Length in mm	Grit	Packing unit/pcs.	Cat. number
115 x 280	40	100	73953
115 x 280	60	100	74436
115 x 280	80	100	72227
115 x 280	120	100	72488

Other grits and sizes available on request.

Please observe: Minimum order quantities for manufactured items see page 115. Please see Applications Guide on page 113-117.

Non-woven web hand pad

## NPA 400



### Properties

Bonding agent	Resin
Grain	Aluminium oxide

### Applications:

Stainless steel	●	Plastic	ⓘ
Metals	●		
Wood	●		
Paint/Varnish	ⓘ		

**Advantages:** Outstanding for surface finishing, e.g. adaptation to an existing surface scratch pattern- Can be used wet and dry

Width x Length in mm	Colour	Grade	Packing unit/pcs.	Cat. number
152 x 229	maroon	very fine	20	342849
152 x 229	brown	coarse	20	342852
152 x 229	green	very fine	20	342853
152 x 229	dark green	very fine	20	342854
152 x 229	maroon	medium	20	342855
152 x 229	maroon	fine	20	342856

Information regarding grit range see chart on page 136.

Non-woven web hand pad

## NPA 500



### Properties

Bonding agent	Resin
Grain	SiC

### Applications:

Paint/Varnish	●	Wood	ⓘ
Plastic	●		
Stainless steel	●		
Metals	ⓘ		

**Advantages:** Outstanding for surface finishing, e.g. adaptation to an existing surface scratch pattern - Can be used wet and dry

Width x Length in mm	Colour	Grade	Packing unit/pcs.	Cat. number
152 x 229	white	without grain	20	342850
152 x 229	grey	ultra fine	20	342851
152 x 229	black	medium	20	342857

Information regarding grit range see chart on page 136.

Other grades and sizes available on request.

Please observe: Please see Applications Guide on page 113-117.

# Non-woven web hand pads

Grit		80 - 100	120 - 150	180 - 220	240 - 320	800 - 1000	Without grain
Grade		coarse	medium	fine	very fine	ultra fine	non-abrasive
Klingspor non-woven web hand pads	Aggressiveness decreasing ↓	coarse A – brown					
			medium SiC – black				
			medium A – maroon				
				fine A – maroon			
					very fine HD – green		
						very fine GP – dark green	
							very fine A – maroon
							non-abrasive – white

Abrasive block, flexible, coated on 4 sides

## SK 500



### Properties

Grain	Aluminium oxide
Coating	Close

### Applications:

Paint/Varnish/Filler	●
Wood	●
Plastic	⦿
Metals	⦿

**Advantages:** Can be used flat and upright (four usable sides) - For flat and profiled surfaces due to flexible foam core - Robust, washable and reusable

### Available grits:

16 24 30 36 40 50 60 80 100 120 150 180 220 240 280 320 360 400 500 600 800 1000 1200 1500 2000

Width x Length x Height in mm	Grit	Density	Grit color	Foam colour	Packing unit/pcs.	Cat. number
100 x 70 x 25	60	hard	brown	gray	100	125279
100 x 70 x 25	80	hard	brown	gray	100	225165
100 x 70 x 25	100	hard	brown	gray	100	125280
100 x 70 x 25	120	hard	brown	gray	100	225166
100 x 70 x 25	180	hard	brown	gray	100	225167
100 x 70 x 25	220	hard	brown	gray	100	225168
100 x 70 x 25	280	hard	brown	gray	100	225169

Abrasive block, flexible, coated on 4 sides

## SK 700 A



### Properties

Grain	Aluminium oxide
Coating	Close

### Applications:

Paint/Varnish/Filler	●
Wood	●
Plastic	⦿
Metals	⦿

**Advantages:** Suitable for flat or upright use on all four sides - The angled edge (approx. 45°) makes it an exceptional choice for narrow, tapering workpiece contours - Excellent contouring and pressure distribution thanks to flexible foam core - Robust, washable and reusable

### Available grits:

16 24 30 36 40 50 60 80 100 120 150 180 220 240 280 320 360 400 500 600 800 1000 1200 1500 2000

Width x Length x Height in mm	Grit	Density	Grit color	Foam colour	Packing unit/pcs.	Cat. number
125 x 89 x 25	60	hard	brown	gray	100	337846
125 x 89 x 25	80	hard	brown	gray	100	337847
125 x 89 x 25	100	hard	brown	gray	100	337848
125 x 89 x 25	120	hard	brown	gray	100	331019

Other grits and sizes available on request.

Please observe: Please see Applications Guide on page 113-114.



# Abrasive sponge

Abrasive sponge, flexible, coated on 2 sides

## SW 501



### Properties

Grain	Aluminium oxide
Coating	Close

### Applications:

Paint/Varnish/Filler	●
Wood	●
Plastic	○
Metals	○

**Advantages:** Satin surface scratch pattern - For low and high profiled surfaces (two usable sides) - Crease and break resistant - Washable and reusable

### Available grits:

16	24	30	36	40	50	60	80	100	120	150	180	220	240	280	320	360	400	500	600	800	1000	1200	1500	2000
Width x Length x Height in mm			Grit	Density	Grit color	Foam colour	Packing unit/pcs.	Cat. number																
123 x 96 x 12,5			120	soft	brown	yellow	100	125281																
123 x 96 x 12,5			220	soft	brown	yellow	100	125282																

Abrasive sponge, flexible, coated on 1 side

## SW 510



### Properties

Grain	Aluminium oxide
Coating	Close

### Applications:

Paint/Varnish/Filler	●
Wood	●
Plastic	○
Metals	○

**Advantages:** Thin, ultra flexible sanding sponge for particularly hard-to-reach areas such as indentations, profiles and edges - Tight foam structure, allowing for exceptionally uniform pressure distribution and an extra fine finish - No bending, no creases - Can be used wet and dry

### Available grits:

16	24	30	36	40	50	60	80	100	120	150	180	220	240	280	320	360	400	500	600	800	1000	1200	1500	2000
Width x Length x Height in mm			Grit	Density	Grit color	Foam colour	Packing unit/pcs.	Cat. number																
115 x 140 x 5			100	hard	white	gray	100	303588																
115 x 140 x 5			180	hard	white	gray	100	303589																
115 x 140 x 5			220	hard	white	gray	100	303590																
115 x 140 x 5			320	hard	white	gray	100	337849																

Other grits and sizes available on request.

Please observe: Please see Applications Guide on page 113-114.

Abrasive sponge, flexible, coated on 2 sides

## SW 502



### Properties

Grain	SiC
Coating	Close

### Applications:

Paint/Varnish/Filler	●
Wood	●
Plastic	○
Metals	○

**Advantages:** Glossy surface scratch pattern - For low and high profiled surfaces (two usable sides) - Crease and break resistant - Washable and reusable

### Available grits:

16	24	30	36	40	50	60	80	100	120	150	180	220	240	280	320	360	400	500	600	800	1000	1200	1500	2000
Width x Length x Height in mm			Grit	Density	Grit color	Foam colour	Packing unit/pcs.	Cat. number																
123 x 96 x 12,5			120	soft	black	yellow	100	244377																
123 x 96 x 12,5			220	soft	black	yellow	100	244379																

Abrasive sponge, flexible, coated on 1 side

## SW 512



### Properties

Grain	SiC
Coating	Close

### Applications:

Paint/Varnish/Filler	●
Plastic	●
Wood	○
Metal	○

**Advantages:** Thin, ultra flexible sanding sponge for particularly hard-to-reach areas such as indentations, profiles and edges - Tight foam structure, allowing for exceptionally uniform pressure distribution and an extra fine finish - No bending, no creases - Can be used wet and dry - Sharp-edged silicon carbide for increased aggressiveness and processing of hard-to-machine materials

### Available grits:

16	24	30	36	40	50	60	80	100	120	150	180	220	240	280	320	360	400	500	600	800	1000	1200	1500	2000
Width x Length x Height in mm			Grit	Density	Grit color	Foam colour	Packing unit/pcs.	Cat. number																
115 x 140 x 5			120	hard	black	gray	100	337850																
115 x 140 x 5			180	hard	black	gray	100	337851																
115 x 140 x 5			220	hard	black	gray	100	337852																
115 x 140 x 5			320	hard	black	gray	100	337853																

Other grits and sizes available on request.

Please observe: Please see Applications Guide on page 113-114.

# Discs

Applications guide

## Hole patterns for discs

Klingspor offers a wide range of products with hole patterns for dust extraction.

You will find the available hole patterns marked in the table below.

The chart on the following product pages shows the most popular types of machines and the required hole pattern.

**GLS 4**  
 Ø 115 mm  
 8 holes Ø 10 mm  
 on hole circle Ø 65 mm

**GLS 5**  
 Ø 125 mm  
 8 holes Ø 10 mm  
 on hole circle Ø 65 mm

**GLS 27**  
 Ø 125 mm  
 8 holes Ø 10 mm  
 on hole circle Ø 90 mm  
 + 1 centre hole Ø 10 mm

**Shape 0**  
 no hole  
 different dimensions

**Shape 10**  
 round hole  
 different dimensions

**Shape 30**  
 star-shaped hole  
 different dimensions

**GLS 1**  
 Ø 150 mm  
 8 holes Ø 10 mm  
 on hole circle Ø 120 mm  
 + 1 centre hole Ø 17 mm

**GLS 2**  
 Ø 150 mm  
 8 holes Ø 10 mm  
 on hole circle Ø 65 mm

**GLS 3**  
 Ø 150 mm  
 6 holes Ø 10 mm  
 on hole circle Ø 80 mm

**GLS 15**  
 Triangular Ø 96 mm  
 6 holes Ø 8 mm  
 on hole circle Ø 52 mm

**GLS 24**  
 98 × 148 mm  
 7 holes Ø 10 mm

**GLS 47**  
 Ø 150 mm  
 8 holes Ø 9 mm  
 on hole circle Ø 120 mm,  
 6 holes Ø 9 mm  
 on hole circle Ø 80 mm  
 + 1 centre hole Ø 17 mm

**GLS 51**  
 Ø 150 mm  
 8 holes Ø 10 mm  
 on hole circle Ø 120 mm,  
 8 holes Ø 8 mm  
 on hole circle Ø 65 mm  
 + 1 centre hole Ø 10 mm

**GLS 74**  
 Ø 150 mm  
 8 holes Ø 9,5 mm  
 on hole circle Ø 119 mm,  
 16 holes Ø 6 mm  
 on hole circle Ø 119 mm  
 8 holes Ø 7 mm  
 on hole circle Ø 95 mm  
 8 holes Ø 8,5 mm  
 on hole circle Ø 65 mm  
 8 holes Ø 6 mm  
 on hole circle Ø 39 mm  
 + 1 centre hole Ø 10 mm

**GLS 52**  
 Ø 225 mm  
 10 holes Ø 12 mm  
 on hole circle Ø 105 mm

Other hole patterns available on request.

### Minimum order quantities for made to order items

Type	Ø [mm]	Minimum order quantities
AN 400	up to 50 mm	5,000 pieces
CS 310 X	up to 90 mm	2,500 pieces
CS 321 X	up to 125 mm	1,000 pieces
CS 411 XK	up to 200 mm	500 pieces
FP 73 WK	up to 400 mm	200 pieces
PS 11 C	up to 600 mm	100 pieces
PS 19 EK	over 600 mm	25 pieces
PS 21 FK		
PS 22 F ACT		
PS 22 K		
PS 33 BK/CK		
PS 61 FK		
PS 73 BWK/CWK		

### Maximum disc diameter

Ø 670 mm	Ø 770 mm	Ø 1,100 mm
PS 21 FK	PS 61 FK	PS 11 C
PS 22 K		PS 19 EK
		PS 33 BK/CK
		FP 73 WK
		PS 73 BWK/CWK
		AN 400
		CS 411 XK
		CS 310 X
		CS 321 X

## Orbital and delta sanders

Manufacturer	Type	Size in mm	Hole pattern
AEG power tools	Delta DSE 260	105 × 105 × 105	GLS 17
	FS 2 D	98 × 148	GLS 24
	EX 400, EXE 400, EX 450, EXE 460-125, EX 125 E, EX 125 ES	125	GLS 5
	EXE 450	convertible to 125	GLS 5
	EXE 450	150	GLS 2 (7)
	EXE 460 - 150, ROS 150 E, EX 150 E	150	GLS 3
	EX/E 450	150	GLS 7
Atlas Copco	LST 21 R350, LST 22 R350, LST 22 R325, LST 20 R350	90	GLS 41
	VS 11 D	98 × 148	GLS 24
	LST 30 H90-11	115	blank
	LST 20 R525, LST 20 R550	125	blank
	LST 21 R525, LST 21 R550, LST 22 R525, LST 22 R550	125	GLS 5
	TXE 150	convertible to 125	GLS 5
	LST 20 R625, LST 20 R650, LST 30 H090-15, LST 30 S090-15	150	blank
	ROS 150 E, LST 21 R625, LST 21 R650, LST 22 R625, LST 22 R650, LST31 H90-15, LST31 S90-15, LST32 H090-15, LST32 S090-15, LST 22 R625-9, G2438-6.5N Pro, G2438-6.5I Pro, G2438-6.3I Pro, G2438-6.10I Pro, G2438-6.5C Pro, G2438-6.3N Pro, G2438-6.3C Pro, G2438-6.10N Pro, G2438-6.10C Pro, G2438-10 self-fastening 6 Pro, LST 22 R650-9	150	GLS 3
	TXE 150	150	GLS 7
		VP510	96 × 96 × 96
Black & Decker	KA 510	94 × 94 × 94	GLS 15
	KA 165 GT (mouse)		GLS 25
	KA 230 E		GLS 34
	BD190, BD190 E, BD190S, BD190D, XTA90EK, KS 191 EK, KA 198, KA 190, KA 190 E, KA 190 S, KA 198GT, KA220, KA220G, KA191EK	125	GLS 5
Bosch	Delta GDA 280 E, Delta PDA 100, PDA 10-92, Delta PDA 120 E, Delta PDA 240 E, PDA 180, PDA 180 E	96 × 96 × 96	GLS 15
	PEX 11 A, PEX 115, PEX 11 AE	115	GLS 4
	PEX 300 A/AE, GEX 125-150 AVE Professional, PEX 400 AE, PEX 12 A, PEX 12 AE, PEX 125 A-1, PEX 125 AE, PEX 270 A/AE, GEX 125 A, GEX 125 AC, GEX 125-1 AE, PEX 220 A	125	GLS 5
	PEX 15 AE, GEX 150 AE, GEX 150 AC/E, GEX 150 Turbo, PEX 420 AE	150	GLS 3
	ES 55 E, DW423, D26453	125	GLS 5
DeWalt	ES 56 E, ES 56 EK, DW443, D 26410	150	GLS 3
	DE-G 200 E	94 × 94 × 94	GLS 15
Einhell	EX 115	115	GLS 4
	EX-G 125 E, BES 125, EX-G 125, BT-RS 420 E, BES 125 E, BRS 380 E	125	GLS 5
	LL 107 VEA	115	blank
Fein	MSf 636-1, M 10000-5, XS 712	125	GLS 5
	MSf 636-1	150	GLS 26
	MSf 649-2 a/b, M 10000-6	150	GLS 2 (7)
	ROT 14-200 E	150	GLS 2
	X 1107 VE	150	GLS 3
	ROT 14-200 E	200	GLS 9
Felisatti	TP 521/AS, TP 521/E, TP 522 AS/CE, RGF 150/600 E	150	GLS 3

Manufacturer	Type	Size in mm	Hole pattern
Festool	RO 90 DX FEQ-Plus	90	GLS 41
	DS 400, DTS 400	98 × 148	GLS 24
	DX 93	94 × 94 × 94	GLS 16
	ES 125, ES 125 E, ES 125 E-PLUS, ES 125 PLUS	125	GLS 5
	ES 125 EQ-Plus; ES 125 EQ, ES 125 Q-Plus, ES 125 Q, ETS 125, LEX 2 125/3, LEX 1 125/7, LEX 3 125/3, LEX 3 125/5	125	GLS 27
	RO 125 FEQ-Plus	125	GLS 27
	ET 2 E	150	GLS 2
	ET 2 E - Plus, RO 150, RO 150 E, RO 2 E-Plus, LEX 3 150/3, LEX 150, ETS 150/3, ETS 150/5, WTS 150/7 E, WTS 150/7 E-Plus, ETS 150/5 EQ, ETS 150/5 EQ-E, ETS 150/5 EQ-Plus	150	GLS 1
	Multi-Jetstream (8+8+1)	150	GLS 51
	LHS 225 EQ-Plus	225	GLS 38
Flex	OD 100-2, ODE 100-2	98 × 148	GLS 24
	XS 712, XS 713	125	GLS 5
	X 1107 VE, XS 1107 VE	150	GLS 3
	ORE 125-2	125	GLS 27
Hilti	GE 5, GE 5 R, GSE 5 R, WST 700VV, WST 700 VV Plus	225	GLS 52
	WST 700 VV Plus	285	GLS 60
Hitachi	WFE 150, WFE 380, WFE 450 E	150	GLS 3
	FSV 13 Y, TSV 13 Y, SV 13 YA	125	GLS 5
HOLZ HER	SAY 150 A	150	GLS 3
	2445	150	GLS 7 (1)
Kress	CDS 6425, CDS 6420, CDS 6422 E	105	GLS 17
	CPS 6115-1, 6115 E	115	GLS 4
	CPS 6125-1, CPS 6125 E, CPS 6125 E SET, HEX 1385 E, HEX 6385 E, 300 EXE	125	GLS 5
	900 MPS, 900 HEX /2	150	GLS 3
Mafell	UT 150 E, UX 150 E	150	GLS 1, 3, 47
	BO 4561, BO 4565	96 × 96 × 96	GLS 15
Makita	BO 5000, BO 5010, BO 5041, BO 5031 K, BO 5021, BO 5021 K, BO 5041 K	125	GLS 5
	BO 6030, BO 6040 J	150	GLS 1
	DS E 130, DS E 170, DS E 180	96 × 96 × 96	GLS 15
Metabo	DSE 300, DSE 300 Intec, DSE 280 INTEC	94 × 94 × 94	GLS 15
	SXE 400	80	GLS 13
	SX E 125, FSX 200 INTEC, SXE 425 TURBOTECH, SX E 425, SXE 325 INTEC	125	GLS 5
	SX E 425 XL, SX E 450 Duo, SXE 450 TURBOTECH,	150	GLS 3
Milwaukee	PDS 13, FS 2 D	98 × 148	GLS 24
	PRS 125 E	125	GLS 5
Peugeot	ROS 150 E	150	GLS 3
	PAE 115	115	GLS 4
Pro Tool	PRX 150 E	150	GLS 3
	ESP 150 E	150	GLS 3
Ryobi	ERO 2412V, CRO 180M, ROS 300 A, CRO 180 MHG	125	GLS 5
	7110 AA, 7115 AA	96 × 96 × 96	GLS 15
SKIL	7415	115	GLS 4
	7400, 7425, 7430, 7435, 7440 AA, 7460 AA, 7470 MA	125	GLS 5
Stayer	RO 150 E, LRT 150	150	GLS 3
	LRE 84 H, RTE84H	125	GLS 5
Wegoma	RX 91 C, RT188N, RTE46L, RTE146L	150	GLS 3

Please contact Klingspor if you cannot find the machine used by you on this list. We will be pleased to assist you further. If the product you require is not in stock, we will manufacture it for you subject to a minimum order quantity.

# Discs with paper backing

Coated abrasives

Abrasive paper, waterproof

## PS 11 C



### Properties

Bonding agent	Resin
Grain	SiC
Coating	Close
Backing	C-paper

### Applications:

Paint/Varnish/Filler	●
Metals	●
Glass/Stone	◐
Plastic	◑

**Advantages:** Special product for auto repair and painting - Ideal for hard and tough surfaces - Excellent adaptation of the disc while maintaining high stability - Can be used for wet and dry grinding

### Available grits:

16 24 30 36 40 50 60 80 100 120 150 180 220 240 280 320 360 400 500 600 800 1000 1200 1500 2000

All sizes and minimum purchasing quantities available on request

Other grits and sizes available on request.

Please observe: Minimum order quantities for manufactured items see page 140. Please see Applications Guide on page 113-114, 140-141.

# Discs with paper backing, self-fastening

Coated abrasives



Abrasive paper, self-fastening

## PS 19 EK



### Properties

Bonding agent	Resin
Grain	SiC
Coating	Close
Backing	E-paper

### Applications:

Wood	●
Paint/Varnish/Filler	●
Plastic	●
Glass/Stone	●

**Advantages:** Hard and sharp silicon carbide grain for hard and tough materials - Resistant high-performance disc with a stable E-paper backing for rough, intermediate and finish sanding

Available grits:

16 24 30 36 40 50 60 80 100 120 150 180 220 240 280 320 360 400 500 600 800 1000 1200 1500 2000

Diameter in mm	Grit	Hole pattern	Packing unit/pcs.	Cat. number
115	40	○ 0	50	287798
115	60	○ 0	50	300290
115	80	○ 0	50	305763
115	100	○ 0	50	311087
115	120	○ 0	50	300291
115	220	○ 0	50	309073
115	320	○ 0	50	321743
115	400	○ 0	50	321744
115	600	○ 0	50	322637

Abrasive paper, self-fastening

## PS 21 FK



### Properties

Bonding agent	Resin
Grain	Zirconia alumina
Coating	Close
Backing	F-paper

### Applications:

Steel	●
Stainless steel	●
Metals	●

**Advantages:** Aggressive abrasive behavior due to self-sharpening zirconia alumina - Optimal recipe for rough grinding and finish grinding of stainless steel - Long service life

Available grits:

16 24 30 36 40 50 60 80 100 120 150 180 220 240 280 320 360 400 500 600 800 1000 1200 1500 2000

Diameter in mm	Grit	Hole pattern	Packing unit/pcs.	Cat. number
115	40	○ 0	50	237224
115	60	○ 0	50	248808
115	80	○ 0	50	249326
115	120	○ 0	50	249327

Other grits and sizes available on request.

Please observe: Minimum order quantities for manufactured items see page 140. Please see Applications Guide on page 113-114, 140-141.

Continuation →



# Discs with paper backing, self-fastening

Coated abrasives

→ Continuation of PS 21 FK, Abrasive paper, self-fastening

Diameter in mm	Grit	Hole pattern	Packing unit/pcs.	Cat. number
115	150	○ 0	50	248809
115	240	○ 0	50	255347
125	40	○ 0	50	246857
125	60	○ 0	50	237780
125	80	○ 0	50	237781
125	120	○ 0	50	237782
125	150	○ 0	50	255348
125	240	○ 0	50	237785
150	40	○ 0	50	230312
150	60	○ 0	50	230313
150	80	○ 0	50	230314
150	120	○ 0	50	246488
150	150	○ 0	50	239244
150	240	○ 0	50	251509

Abrasive paper, self-fastening

## PS 22 K



### Properties

Bonding agent	Resin
Grain	Aluminium oxide
Coating	Semi-open
Backing	E-paper

### Applications:

Wood	●	Plastic	⓪
Metals	●		
Stainless steel	⓪		
Paint/Varnish/Filler	⓪		

**Advantages:** Universal abrasive disc for metalworking and woodworking - Uniform surface scratch pattern - Available in many grit sizes and dimensions

Available grits:

16 24 30 36 40 50 60 80 100 120 150 180 220 240 280 320 360 400 500 600 800 1000 1200 1500 2000

Diameter in mm	Grit	Hole pattern	Packing unit/pcs.	Cat. number
96	40	△ GLS 15	50	142134
96	60	△ GLS 15	50	142135
96	80	△ GLS 15	50	142136
96	100	△ GLS 15	50	145055
96	120	△ GLS 15	50	142137
96	150	△ GLS 15	50	146336
96	180	△ GLS 15	50	142138
96	240	△ GLS 15	50	142139

Other grits and sizes available on request.

Please observe: Minimum order quantities for manufactured items see page 140. Please see Applications Guide on page 113-114, 140-141.

# Discs with paper backing, self-fastening

Coated abrasives



Abrasive paper, self-fastening

## PS 22 K



### Properties

Bonding agent	Resin
Grain	Aluminium oxide
Coating	Semi-open
Backing	E-paper

### Applications:

Wood	●
Metals	●
Stainless steel	⦿
Paint/Varnish/Filler	⦿

Plastic	⦿
---------	---

**Advantages:** Universal abrasive disc for metalworking and woodworking - Uniform surface scratch pattern - Available in many grit sizes and dimensions

### Available grits:

16 24 30 36 40 50 60 80 100 120 150 180 220 240 280 320 360 400 500 600 800 1000 1200 1500 2000

Diameter in mm	Grit	Hole pattern	Packing unit/pcs.	Cat. number
115	24	○ 0	50	6754
115	40	○ 0	50	2785
115	60	○ 0	50	2786
115	80	○ 0	50	6756
115	100	○ 0	50	2787
115	120	○ 0	50	6757
115	150	○ 0	50	80046
115	180	○ 0	50	2788
115	220	○ 0	50	88330
115	240	○ 0	50	88333
115	320	○ 0	50	95561
115	400	○ 0	50	111470
115	40	⊗ GLS 4	50	82938
115	60	⊗ GLS 4	50	82940
115	80	⊗ GLS 4	50	82941
115	100	⊗ GLS 4	50	82942
115	120	⊗ GLS 4	50	82944
115	180	⊗ GLS 4	50	82946
115	240	⊗ GLS 4	50	87424
125	24	○ 0	50	7300
125	40	○ 0	50	2294
125	60	○ 0	50	2295
125	80	○ 0	50	6774
125	100	○ 0	50	2296
125	120	○ 0	50	6775
125	150	○ 0	50	78163
125	180	○ 0	50	62107
125	220	○ 0	50	97176
125	240	○ 0	50	91922
125	320	○ 0	50	93284
125	400	○ 0	50	130114
125	24	⊗ GLS 5	50	89485
125	40	⊗ GLS 5	50	89486
125	60	⊗ GLS 5	50	89488

Other grits and sizes available on request.

Continuation →

Please observe: Minimum order quantities for manufactured items see page 140. Please see Applications Guide on page 113-114, 140-141.

# Discs with paper backing, self-fastening

Coated abrasives

→ Continuation of PS 22 K, Abrasive paper, self-fastening

Diameter in mm	Grit	Hole pattern	Packing unit/pcs.	Cat. number
125	80	⊗ GLS 5	50	89489
125	100	⊗ GLS 5	50	89491
125	120	⊗ GLS 5	50	89493
125	150	⊗ GLS 5	50	89494
125	180	⊗ GLS 5	50	89495
125	220	⊗ GLS 5	50	90758
125	240	⊗ GLS 5	50	92753
125	320	⊗ GLS 5	50	89496
125	400	⊗ GLS 5	50	104778
125	40	⊗ GLS 27	50	260795
125	60	⊗ GLS 27	50	260796
125	80	⊗ GLS 27	50	260797
125	100	⊗ GLS 27	50	260798
125	120	⊗ GLS 27	50	260799
125	150	⊗ GLS 27	50	260800
125	180	⊗ GLS 27	50	260801
125	240	⊗ GLS 27	50	260802
150	24	○ 0	50	2474
150	40	○ 0	50	20207
150	60	○ 0	50	6649
150	80	○ 0	50	6936
150	100	○ 0	50	6697
150	120	○ 0	50	6937
150	150	○ 0	50	71140
150	180	○ 0	50	4022
150	220	○ 0	50	93324
150	240	○ 0	50	91605
150	320	○ 0	50	91721
150	400	○ 0	50	129092
150	24	⊗ GLS 1	50	6516
150	40	⊗ GLS 1	50	6520
150	60	⊗ GLS 1	50	6523
150	80	⊗ GLS 1	50	6524
150	100	⊗ GLS 1	50	6525
150	120	⊗ GLS 1	50	6526
150	150	⊗ GLS 1	50	80722
150	180	⊗ GLS 1	50	6611
150	220	⊗ GLS 1	50	98990
150	240	⊗ GLS 1	50	89451
150	320	⊗ GLS 1	50	89450
150	400	⊗ GLS 1	50	129389
150	40	⊗ GLS 2	50	74088
150	60	⊗ GLS 2	50	72633
150	80	⊗ GLS 2	50	72632
150	100	⊗ GLS 2	50	73490
150	120	⊗ GLS 2	50	72628
150	150	⊗ GLS 2	50	79862
150	180	⊗ GLS 2	50	72624
150	240	⊗ GLS 2	50	91814
150	24	⊗ GLS 3	50	93321
150	40	⊗ GLS 3	50	89181

Other grits and sizes available on request.

Continuation →

Please observe: Minimum order quantities for manufactured items see page 140. Please see Applications Guide on page 113-114, 140-141.

# Discs with paper backing, self-fastening

Coated abrasives



→ Continuation of PS 22 K, Abrasive paper, self-fastening

Diameter in mm	Grit	Hole pattern	Packing unit/pcs.	Cat. number
150	60	⊙ GLS 3	50	86634
150	80	⊙ GLS 3	50	86635
150	100	⊙ GLS 3	50	97072
150	120	⊙ GLS 3	50	86636
150	150	⊙ GLS 3	50	86637
150	180	⊙ GLS 3	50	87528
150	220	⊙ GLS 3	50	100157
150	240	⊙ GLS 3	50	97778
150	320	⊙ GLS 3	50	97779
150	400	⊙ GLS 3	50	128356
150	40	⊗ GLS 51	50	306611
150	60	⊗ GLS 51	50	306612
150	80	⊗ GLS 51	50	305559
150	100	⊗ GLS 51	50	306507
150	120	⊗ GLS 51	50	305560
150	150	⊗ GLS 51	50	306508
150	180	⊗ GLS 51	50	306509
150	240	⊗ GLS 51	50	309471
150	40	⊗ GLS 74	50	342419
150	60	⊗ GLS 74	50	342418
150	80	⊗ GLS 74	50	340766
150	100	⊗ GLS 74	50	342423
150	120	⊗ GLS 74	50	342159
150	150	⊗ GLS 74	50	342422
150	180	⊗ GLS 74	50	342421
150	240	⊗ GLS 74	50	340761
180	24	○ 0	50	2782
180	40	○ 0	50	2476
180	60	○ 0	50	2477
180	80	○ 0	50	6914
180	100	○ 0	50	2783
180	120	○ 0	50	6915
200	40	○ 0	50	77659
200	60	○ 0	50	77660
200	80	○ 0	50	77656
200	100	○ 0	50	77658
200	120	○ 0	50	77661

Other grits and sizes available on request.

Please observe: Minimum order quantities for manufactured items see page 140. Please see Applications Guide on page 113-114, 140-141.

# Discs with paper backing, self-fastening

Coated abrasives

Abrasive paper, self-fastening

## PS 33 CK



### Properties

Bonding agent	Resin
Grain	Aluminium oxide
Coating	Semi-open
Backing	C-paper

### Applications:

Paint/Varnish/Filler	●
Wood	●
Plastic	○

**Advantages:** High removal rate - For diverse applications

### Available grits:

16 24 30 36 40 50 60 80 100 120 150 180 220 240 280 320 360 400 500 600 800 1000 1200 1500 2000

Diameter in mm	Grit	Hole pattern	Packing unit/pcs.	Cat. number
96	40	△ GLS 15	100	147163
96	60	△ GLS 15	100	147164
96	80	△ GLS 15	100	147165
96	100	△ GLS 15	100	147166
96	120	△ GLS 15	100	148195

Abrasive paper, self-fastening

## PS 33 CK



### Properties

Bonding agent	Resin
Grain	Aluminium oxide
Coating	Semi-open
Backing	C-paper

### Applications:

Paint/Varnish/Filler	●
Wood	●
Plastic	○

**Advantages:** High removal rate - For diverse applications

### Available grits:

16 24 30 36 40 50 60 80 100 120 150 180 220 240 280 320 360 400 500 600 800 1000 1200 1500 2000

Width x Length in mm	Grit	Hole pattern	Packing unit/pcs.	Cat. number
98 x 148	60	△ GLS 24	100	215473
98 x 148	80	△ GLS 24	100	215474
98 x 148	100	△ GLS 24	100	215475
98 x 148	120	△ GLS 24	100	215476

Other grits and sizes available on request.

Please observe: Minimum order quantities for manufactured items see page 140. Please see Applications Guide on page 113-114, 140-141.

# Discs with paper backing, self-fastening

Coated abrasives



Abrasive paper, self-fastening

## PS 33 CK



### Properties

Bonding agent	Resin
Grain	Aluminium oxide
Coating	Semi-open
Backing	C-paper

### Applications:

Paint/Varnish/Filler	●
Wood	●
Plastic	○

**Advantages:** High removal rate - For diverse applications

### Available grits:

16 24 30 36 40 50 60 80 100 120 150 180 220 240 280 320 360 400 500 600 800 1000 1200 1500 2000

Diameter in mm	Grit	Hole pattern	Packing unit/pcs.	Cat. number
115	40	○ 0	100	147701
115	60	○ 0	100	148469
115	80	○ 0	100	147144
115	120	○ 0	100	146955
125	40	○ 0	100	154113
125	60	○ 0	100	147604
125	80	○ 0	100	149055
125	100	○ 0	100	150431
125	120	○ 0	100	150433
125	40	⊗ GLS 5	100	146954
125	60	⊗ GLS 5	100	147642
125	80	⊗ GLS 5	100	147643
125	100	⊗ GLS 5	100	147977
125	120	⊗ GLS 5	100	147170
150	40	○ 0	100	147922
150	60	○ 0	100	147107
150	80	○ 0	100	146739
150	100	○ 0	100	147106
150	120	○ 0	100	146740
150	40	⊗ GLS 1	100	146978
150	60	⊗ GLS 1	100	146979
150	80	⊗ GLS 1	100	143130
150	100	⊗ GLS 1	100	143131
150	120	⊗ GLS 1	100	147093
150	60	⊗ GLS 2	100	147226
150	80	⊗ GLS 2	100	143132
150	100	⊗ GLS 2	100	143133
150	120	⊗ GLS 2	100	147225
150	40	⊗ GLS 3	100	147647
150	60	⊗ GLS 3	100	147124
150	80	⊗ GLS 3	100	146946
150	100	⊗ GLS 3	100	143694
150	120	⊗ GLS 3	100	146947
150	40	⊗ GLS 51	100	310531

Other grits and sizes available on request.

Please observe: Minimum order quantities for manufactured items see page 140. Please see Applications Guide on page 113-114, 140-141.

Continuation →



# Discs with paper backing, self-fastening

Coated abrasives

→ Continuation of PS 33 CK, Abrasive paper, self-fastening

Diameter in mm	Grit	Hole pattern	Packing unit/pcs.	Cat. number
150	60	⊗ GLS 51	100	301874
150	80	⊗ GLS 51	100	301925
150	100	⊗ GLS 51	100	301926
150	120	⊗ GLS 51	100	301927
150	40	⊗ GLS 74	100	340853
150	60	⊗ GLS 74	100	340370
150	80	⊗ GLS 74	100	340371
150	100	⊗ GLS 74	100	342046
150	120	⊗ GLS 74	100	340375
225	40	○ 0	50	223162
225	60	○ 0	50	210124
225	80	○ 0	50	210129
225	100	○ 0	50	224731
225	120	○ 0	50	210130
225	40	⊗ GLS 52	50	302042
225	60	⊗ GLS 52	50	302043
225	80	⊗ GLS 52	50	302044
225	100	⊗ GLS 52	50	302045
225	120	⊗ GLS 52	50	302046

Abrasive paper, self-fastening

## PS 33 BK

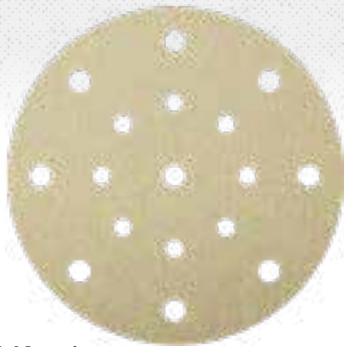

### Properties

Bonding agent	Resin
Grain	Aluminium oxide
Coating	Semi-open
Backing	B-paper

### Applications:

Paint/Varnish/Filler	●
Wood	●
Plastic	⦿

**Advantages:** High removal rate - For diverse applications

Available grits:

16 24 30 36 40 50 60 80 100 120 150 180 220 240 280 320 360 400 500 600 800 1000 1200 1500 2000

Diameter in mm	Grit	Hole pattern	Packing unit/pcs.	Cat. number
125	150	⊗ GLS 5	100	150760
125	180	⊗ GLS 5	100	147837
125	240	⊗ GLS 5	100	147838
150	150	○ 0	100	148375
150	180	○ 0	100	146958
150	220	○ 0	100	149916
150	240	○ 0	100	146959
150	320	○ 0	100	146716
150	400	○ 0	100	147108
150	150	⊗ GLS 1	100	148379
150	180	⊗ GLS 1	100	147095

Other grits and sizes available on request.

Continuation →

Please observe: Minimum order quantities for manufactured items see page 140. Please see Applications Guide on page 113-114, 140-141.

# Discs with paper backing, self-fastening

Coated abrasives



→ Continuation of PS 33 BK, Abrasive paper, self-fastening

Diameter in mm	Grit	Hole pattern	Packing unit/pcs.	Cat. number
150	220	⊙ GLS 1	100	149794
150	240	⊙ GLS 1	100	147094
150	320	⊙ GLS 1	100	147096
150	400	⊙ GLS 1	100	147097
150	150	⊙ GLS 2	100	148377
150	180	⊙ GLS 2	100	147224
150	240	⊙ GLS 2	100	147280
150	150	⊙ GLS 3	100	149151
150	180	⊙ GLS 3	100	146948
150	220	⊙ GLS 3	100	149255
150	240	⊙ GLS 3	100	146907
150	320	⊙ GLS 3	100	147126
150	400	⊙ GLS 3	100	147125
150	150	⊙ GLS 51	100	301928
150	180	⊙ GLS 51	100	304084
150	220	⊙ GLS 51	100	301929
150	240	⊙ GLS 51	100	304815
150	320	⊙ GLS 51	100	301930
150	400	⊙ GLS 51	100	310898
150	150	⊙ GLS 74	100	342045
150	180	⊙ GLS 74	100	340598
150	220	⊙ GLS 74	100	342044
150	240	⊙ GLS 74	100	340599
150	320	⊙ GLS 74	100	342043
150	400	⊙ GLS 74	100	342042
225	220	⊙ GLS 52	50	302049

Abrasive paper, self-fastening

## PS 61 FK



### Properties

Bonding agent	Resin
Grain	Ceramic Al. oxide
Coating	Close
Backing	F-paper

### Applications:

Stainless steel	●
Steel	●
Wood	⊙

**Advantages:** Continuously aggressive abrasive performance - High-performance abrasive disc for stainless steel grinding - Also very good results in repair grinding of parquet flooring

Available grits:

16 24 30 36 40 50 60 80 100 120 150 180 220 240 280 320 360 400 500 600 800 1000 1200 1500 2000

Diameter in mm	Grit	Hole pattern	Packing unit/pcs.	Cat. number
125	60	○ 0	50	322468
125	80	○ 0	50	321597
125	120	○ 0	50	322469
125	150	○ 0	50	322470

Other grits and sizes available on request.

Please observe: Minimum order quantities for manufactured items see page 140. Please see Applications Guide on page 113-114, 140-141.

Continuation →

# Discs with paper / film backing, self-fastening

Coated abrasives

→ Continuation of PS 61 FK, Abrasive paper, self-fastening

Diameter in mm	Grit	Hole pattern	Packing unit/pcs.	Cat. number
125	180	○ 0	50	322471
150	60	○ 0	50	322036
150	80	○ 0	50	321325
150	120	○ 0	50	322472
150	150	○ 0	50	322473
150	180	○ 0	50	321797

Abrasive film, active coated, self fastening

## FP 73 WK



### Properties

Bonding agent	Resin
Grain	Aluminium oxide
Coating	Semi-open
Backing	Film

### Applications:

Paint/Varnish/Filler	●
Plastic	⦿



**Advantages:** Special product with highly tear-resistant film backing for use on paint, varnish and fillers - Very good adaptation of the discs with excellent grit adhesion also in the edge area - Substantially reduced clogging and significantly longer service life

Available grits:

Diameter in mm	Grit	Hole pattern	Packing unit/pcs.	Cat. number
150	80	⦿ GLS 47	100	320641
150	100	⦿ GLS 47	100	320642
150	120	⦿ GLS 47	100	320643
150	150	⦿ GLS 47	100	320644
150	180	⦿ GLS 47	100	320725
150	240	⦿ GLS 47	100	320726
150	320	⦿ GLS 47	100	320727
150	400	⦿ GLS 47	100	320728
150	600	⦿ GLS 47	100	320729
150	800	⦿ GLS 47	100	320730
150	1000	⦿ GLS 47	100	320731
150	1200	⦿ GLS 47	100	320732
150	1500	⦿ GLS 47	100	320733

Other grits and sizes available on request.

Please observe: Minimum order quantities for manufactured items see page 140. Please see Applications Guide on page 113-114, 140-141.

# Discs with paper backing, self-fastening

Coated abrasives



Abrasive paper, actively coated, self-fastening

## PS 73 CWK



### Properties

Bonding agent	Resin
Grain	Aluminium oxide
Coating	Semi-open
Backing	C-paper

### Applications:

Paint/Varnish/Filler	●
Plastic	⓪

**Advantages:** High-quality product for use on varnish, paint and filler - High removal rate - Substantially reduced clogging and significantly longer service life due to additional special coating

### Available grits:

16 24 30 36 40 50 60 80 100 120 150 180 220 240 280 320 360 400 500 600 800 1000 1200 1500 2000

Diameter in mm	Grit	Hole pattern	Packing unit/pcs.	Cat. number
150	40	○ 0	100	301231
150	60	○ 0	100	301232
150	80	○ 0	100	301233
150	100	○ 0	100	301234
150	120	○ 0	100	301235
150	40	⊗ GLS 1	100	301205
150	60	⊗ GLS 1	100	301206
150	80	⊗ GLS 1	100	301207
150	120	⊗ GLS 1	100	301209
150	40	⊗ GLS 3	100	301218
150	60	⊗ GLS 3	100	301219
150	80	⊗ GLS 3	100	301220
150	100	⊗ GLS 3	100	301221
150	120	⊗ GLS 3	100	301222
150	40	⊗ GLS 47	100	301810
150	60	⊗ GLS 47	100	301811
150	80	⊗ GLS 47	100	301812
150	100	⊗ GLS 47	100	301813
150	120	⊗ GLS 47	100	301814
150	80	⊗ GLS 51	100	310524
150	120	⊗ GLS 51	100	310478

Other grits and sizes available on request.

Please observe: Minimum order quantities for manufactured items see page 140. Please see Applications Guide on page 113-114, 140-141.

# Discs with paper backing, self-fastening

Coated abrasives

Abrasive paper, actively coated,  
self-fastening

## PS 73 BWK



### Properties

Bonding agent	Resin
Grain	Aluminium oxide
Coating	Semi-open
Backing	B-paper

### Applications:

Paint/Varnish/Filler	●
Plastic	○

**Advantages:** High-quality product for use on varnish, paint and filler - High removal rate - Substantially reduced clogging and significantly longer service life due to additional special coating

### Available grits:

Diameter in mm	Grit	Hole pattern	Packing unit/pcs.	Cat. number
150	150	○ 0	100	301236
150	180	○ 0	100	301237
150	220	○ 0	100	301238
150	240	○ 0	100	301239
150	320	○ 0	100	301240
150	400	○ 0	100	301241
150	500	○ 0	100	301937
150	800	○ 0	100	301886
150	1000	○ 0	100	301891
150	150	⊗ GLS 1	100	301210
150	180	⊗ GLS 1	100	301211
150	240	⊗ GLS 1	100	301213
150	320	⊗ GLS 1	100	301214
150	400	⊗ GLS 1	100	301215
150	500	⊗ GLS 1	100	301216
150	600	⊗ GLS 1	100	301217
150	800	⊗ GLS 1	100	301890
150	150	⊙ GLS 3	100	301223
150	180	⊙ GLS 3	100	301224
150	220	⊙ GLS 3	100	301225
150	240	⊙ GLS 3	100	301226
150	320	⊙ GLS 3	100	301227
150	400	⊙ GLS 3	100	301228
150	500	⊙ GLS 3	100	301229
150	600	⊙ GLS 3	100	301230
150	800	⊙ GLS 3	100	301889
150	150	⊗ GLS 47	100	301855
150	180	⊗ GLS 47	100	301856
150	220	⊗ GLS 47	100	301857
150	240	⊗ GLS 47	100	301858
150	320	⊗ GLS 47	100	301859
150	400	⊗ GLS 47	100	301860
150	500	⊗ GLS 47	100	301861
150	600	⊗ GLS 47	100	301862

Other grits and sizes available on request.

Continuation →

Please observe: Minimum order quantities for manufactured items see page 140. Please see Applications Guide on page 113-114, 140-141.

# Discs with paper backing, self-fastening / Abrasive screen

Coated abrasives



→ Continuation of PS 73 BWK, Abrasive paper, actively coated, self-fastening

Diameter in mm	Grit	Hole pattern	Packing unit/pcs.	Cat. number
150	180	⊗ GLS 51	100	310525
150	220	⊗ GLS 51	100	310526
150	240	⊗ GLS 51	100	309093
150	320	⊗ GLS 51	100	309094
150	400	⊗ GLS 51	100	310527

Abrasive screen, self-fastening, waterproof

## AN 400



### Properties

Bonding agent	Resin
Grain	Aluminium oxide
Backing	Polyester screen

### Applications:

Paint/Varnish/Filler	●	Composite materials	●
Gel coats	●	Wood	●
Plaster	●	Wood based materials	●
Plasterboard walls	●		

**Advantages:** Effective and full-surface dust extraction thanks to open grid structure - Dust-free grinding extends the service life of the abrasive - At the same time, improved health and safety thanks to reduced dust formation at the work station - Independent of existing extraction hole patterns - Waterproof

Available grits:

16 24 30 36 40 50 60 80 100 120 150 180 220 240 280 320 360 400 500 600 800 1000 1200 1500 2000

Diameter in mm	Grit	Packing unit/pcs.	Cat. number
125	80	50	337898
125	100	50	337899
125	120	50	337900
125	150	50	337901
125	180	50	337905
125	240	50	337904
125	320	50	337903
125	400	50	337902
150	80	50	337886
150	100	50	337887
150	120	50	337885
150	150	50	337884
150	180	50	337883
150	240	50	337888
150	320	50	337876
150	400	50	337877
225	80	25	337871
225	100	25	337875
225	120	25	337873
225	150	25	337874
225	180	25	337872
225	240	25	337878

Other grits and sizes available on request.

Please observe: Minimum order quantities for manufactured items see page 140. Please see Applications Guide on page 113-114, 140-141.



# Discs with paper backing, self-fastening / Backing pads

Coated abrasives

Grinding disk with foam material, self-fastening

## FD 500

**NEW**



### Properties

Bonding agent	Resin
Grain	Aluminium oxide/SiC
Backing	Foam velour

### Applications:

Paint/Varnish/Filler	●
----------------------	---

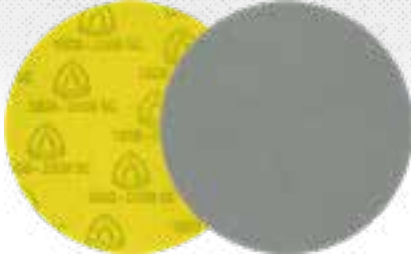

**Advantages:** Uniform pressure distribution thanks to elastic foam coating - Soft grinding and extremely fine scratch pattern - Superior flexibility and adaptability on contours and profiles - Exceptionally well suited for finish grinding - Suitable for wet and dry use - Available in grit 1000, 1500 (Aluminium oxide) and 2000, 3000 (SiC)

### Available grits:

16	24	30	36	40	50	60	80	100	120	150	180	220	240	280	320	360	400	500	600	800	1000	1200	1500	2000	3000
Diameter in mm	Grit	Hole pattern	Packing unit/pcs.	Cat. number																					
125	1000	○ 0	10	342291																					
125	1500	○ 0	10	342290																					
125	2000	○ 0	10	342289																					
125	3000	○ 0	10	342288																					
150	1000	○ 0	10	342294																					
150	1500	○ 0	10	342293																					
150	2000	○ 0	10	342295																					
150	3000	○ 0	10	342292																					

Multihole backing pad for random orbital sanders

## HST 555



**Advantages:** Very good adhesion for all velour-coated discs due to fine, heat resistant self-fastening coating - For all standard hole patterns, also for netlike and diverse multihole patterns - Compatible with all standard orbital sanders

Diameter in mm	Adaptor	Thread/Shaft	Density	Max. RPM	Packing unit/pcs.	Cat. number
150	Festool adaptor	thread M8/ 5/16"	soft	12000 rpm	1	320488
150	Festool adaptor	thread M8/ 5/16"	medium	12000 rpm	1	320489
150	Festool adaptor	thread M8/ 5/16"	hard	12000 rpm	1	320587

Other grits and sizes available on request.

Please observe: Please see Applications Guide on page 113-114, 140-141.

Multihole backing pad for random orbital sanders

## HST 555 A



**Advantages:** Very good adhesion for all velour-coated discs due to fine, heat resistant self-fastening coating - For all standard hole patterns, also for netlike and diverse multihole patterns - Self-fastening backing pad compatible with BOSCH GEX-150 series

Diameter in mm	Adaptor	Thread/Shaft	Density	Max. RPM	Packing unit/pcs.	Cat. number
150	Bosch adaptor	thread M8	medium	12000 rpm	1	320490

# Discs with cloth backing, self-fastening

Coated abrasives

Abrasive cloth, self-fastening

## CS 411 XK



### Properties

Bonding agent	Resin
Grain	Zirconia alumina
Coating	Close
Backing	X-cotton

### Applications:

Stainless steel	●
Steel	●
Metals	●
Wood	●

**Advantages:** Aggressive abrasive behavior due to self-sharpening zirconia alumina - Resistant high-performance abrasive disc with tear-resistant cotton backing for rough and intermediate sanding on edges and surfaces

### Available grits:

16	24	30	36	40	50	60	80	100	120	150	180	220	240	280	320	360	400	500	600	800	1000	1200	1500	2000
----	----	----	----	----	----	----	----	-----	-----	-----	-----	-----	-----	-----	-----	-----	-----	-----	-----	-----	------	------	------	------

Diameter in mm	Grit	Hole pattern	Packing unit/pcs.	Cat. number
115	24	○ 0	50	301371
115	40	○ 0	50	291979
115	60	○ 0	50	278073
115	80	○ 0	50	279638
115	120	○ 0	50	292166
125	24	○ 0	50	310461
125	40	○ 0	50	291980
125	60	○ 0	50	182412
125	80	○ 0	50	238954
125	120	○ 0	50	326051
150	24	○ 0	50	294918
150	40	○ 0	50	301271
150	60	○ 0	50	64647
150	80	○ 0	50	285565
150	120	○ 0	50	285566

Other grits and sizes available on request.

Please observe: Minimum order quantities for manufactured items see page 140. Please see Applications Guide on page 113-114, 140-141.

Backing pad for self-fastening discs

## HST 359



**Advantages:** Good adhesion for all velour-coated abrasive discs - For medium-duty rough grinding and polishing

Diameter in mm	Thread/Shaft	Packing unit/pcs.	Cat. number
115	thread M10	1	70432
115	thread M14	1	70433
115	8 mm	1	6874
125	thread M14	1	70434
125	8 mm	1	70435
150	thread M14	1	70436
180	thread M14	1	73066

Self-fastening support

## CS 396 Y



### Properties

Engaging elements	Mushroom heads
Thickness	1,5 mm
Temperature range	-30° to +80°

**Advantages:** Can be cut to size easily - Simple and safe fixing on smooth and even surfaces - Allows a quick change of the abrasive

All sizes and minimum purchasing quantities available on request

# Non-woven web discs

Non-woven web disc, self-fastening

## NDS 400 K



**NEW**



### Properties

Bonding agent	Resin
Grain	Aluminium oxide/SiC
Backing	Non-woven web

### Applications:

Metals	●	Plastic	●
Steel	●		
Stainless steel	●		
Paint/Varnish/Filler	●		

**Advantages:** Creates an omnidirectional, ultra-fine satin finish on stainless steel surfaces - Effortless cleaning of metal surfaces - Removal of thin layers of oxidation on NF metal - Preparation of surfaces for subsequent coating - Roughening of painted and plastic surfaces - Available in ultra fine (SiC) and very fine (Aluminium oxide)

### Available grits:

16	24	30	36	40	50	60	80	100	120	150	180	220	240	280	320	360	400	500	600	800	1000	1200	1500	2000
Diameter in mm	Grit	Colour	Grade	Packing unit/pcs.	Cat. number																			
150	320	maroon	very fine	20	342640																			
150	600	grey	ultra fine	20	342641																			

Non-woven web disc

## SV 484



### Properties

Bonding agent	Resin
Grain	Aluminium oxide
Backing	Non-woven web with polyester lining

### Applications:

Paint/Varnish/Filler	●	Stainless steel	●
Wood	●		
Plastic	●		
Metals	●		

**Advantages:** Universal non-woven web disc with outstanding price-performance ratio - Soft and elastic grinding - Can be used wet and dry

### Available grits:

16	24	30	36	40	50	60	80	100	120	150	180	220	240	280	320	360	400	500	600	800	1000	1200	1500	2000
Diameter in mm	Grit	Grade	Packing unit/pcs.	Cat. number																				
115	80	coarse	10	104134																				
115	100	medium	10	104135																				
115	180	medium	10	104138																				
115	280	very fine	10	104139																				
125	80	coarse	10	104136																				
125	100	medium	10	104137																				
125	180	medium	10	104140																				
125	280	very fine	10	104141																				

Other grits/grades and sizes available on request.

Please observe: Please see Applications Guide on page 113-114, 140-141.

Non-woven web disc

## NDS 800



### Properties

Bonding agent	Resin
Grain	Aluminium oxide
Backing	Non-woven web with polyester lining

### Applications:

Metals	●	Wood	●
Stainless steel	●		
Paint/Varnish/Filler	○		
Plastic	○		

**Advantages:** High edge stability - Aggressive abrasive behaviour - Long service life - Can be used for wet and dry grinding

### Available grits:

16 24 30 36 40 50 60 80 100 120 150 180 220 240 280 320 360 400 500 600 800 1000 1200 1500 2000

Diameter in mm	Grit	Colour	Grade	Packing unit/pcs.	Cat. number
115	50	brown	coarse	10	258430
115	100	maroon	medium	10	258431
115	180	blue	very fine	10	258432
125	50	brown	coarse	10	258433
125	100	maroon	medium	10	258434
125	180	blue	very fine	10	258445

Backing pad for non-woven web discs

## NDS 555



**Advantages:** Good adhesion for non-woven web discs - For medium-duty rough grinding and polishing

Diameter in mm	Thread/Shaft	Packing unit/pcs.	Cat. number
115	thread M14	1	164100
125	thread M14	1	208275

Other grits/grades and sizes available on request.

Please observe: Please see Applications Guide on page 113-114, 140-141.





# Quick Change Discs

## About the product





Klingspor Quick Change Discs are designed for use on pneumatic and electric die grinders. The Quick Change Discs allow a fast and safe tool change.

## Applications

- ▶ Tool design and construction
- ▶ Aviation industry
- ▶ Engine construction
- ▶ Turbine blade construction
- ▶ Mould construction
- ▶ Container and apparatus construction
- ▶ Model building / model making

## Advantages

- ▶ Simple and fast disc changes reduce set-up times
- ▶ No clip or self-fastening device so no slipping or release caused by heat
- ▶ Disc stays centred
- ▶ Simple handling and smooth running characteristics
- ▶ Diverse applications thanks to different dimensions and backing plate hardnesses

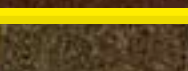
Coated abrasive	Type	Grain	Coating	Characteristics	Page
	<b>QMC/QRC 412</b>	Aluminium oxide	●	The versatile disc for coarse and intermediate grinding on metal	<b>166, 170</b>
	<b>QMC/QRC 411</b>	Zirconia alumina	●	High stock removal rate for rough grinding and deburring of stainless steel and steel	<b>167, 170</b>
	<b>QMC/QRC 409</b>	Zirconia alumina	●	Extremely high stock removal rate and long service life for stainless steel and high alloy steels with multibond for cool grinding	<b>167, 171</b>
	<b>QMC/QRC 910</b>	Ceramic aluminium oxide	●	Extremely sharp ceramic grain for highest aggressivity and multibond for cool grinding	<b>168, 172</b>
	<b>QMC/QRC 400</b>	Aluminium oxide		Soft non-woven web disc for finishing and cleaning work	<b>168, 172</b>
	<b>QMC/QRC 800</b>	Aluminium oxide		Firm surface conditioning disc for cleaning and light deburring work, blending and processing of grinding marks	<b>169, 173</b>

# Quick Change Discs

Applications guide

## Minimum order quantities for made to order items

QCD	Diameter	Minimum order quantities
<i>QRC/QMC 412</i>	25 mm	1,700 pieces
<i>QRC/QMC 411</i>	38 mm	1,200 pieces
<i>QRC/QMC 409</i>	50 mm	900 pieces
<i>QRC/QMC 910</i>	76 mm	600 pieces

QCD	Diameter	Minimum order quantities
<i>QRC/QMC 800</i>	38 mm	400 pieces
	50 mm	350 pieces
	76 mm	350 pieces
<i>QRC/QMC 400</i>	38 mm	700 pieces
	50 mm	500 pieces
	76 mm	375 pieces

## The right choice of the backing pad

Backing pads for Quick Change Discs are available in grades according to the required application. The firmer the backing pad the higher the stock removal rate. Softer backing plates are suited to working on contoured surfaces and finish sanding.

The QCA 555 (cat. no. 308693) allows use on a regular angle grinder.

**Please observe the max. RPM for the backing pads in the product chart.**

Two fastening systems have prevailed on the market for the product group 'Quick Change Discs'. Klingspor can offer you both, Quick Metal Connect and Quick Roll Connect, for all available types.





# Quick Change Discs

Applications guide



## The system QMC (Quick Metal Connect)

The Quick Change Discs with metal locking are fixed on the backing pad by means of an internal thread.



## The system QRC (Quick Roll Connect)

Fix the Quick Change Disc to the backing plate using the plastic threaded bushing and secure by turning 180° clockwise.



## Installation on an angle grinder

The QCA 555 adapter allows you to use the quick change discs on conventional angle grinders with an M14 receiving spindle.

1. Mount the QCA 555 adapter with the M14 thread onto your angle grinder. The lower clamping flange can remain on the machine.
2. Affix the backing pad QMC 555 or QRC 555 with the 1/4" thread on top of the adapter.



# Quick Change Discs

Quick Metal Connect

Quick Change Disc

## QMC 412

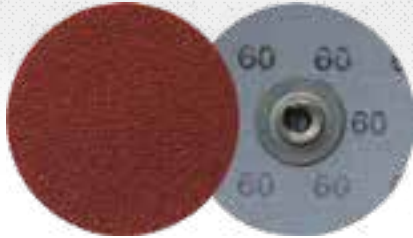

Properties	
Bonding agent	Resin
Grain	Aluminium oxide
Coating	Close

Applications:	
Metals	●
NF metals	●

**Advantages:** For universal use in coarse and intermediate grinding

### Available grits:

16	24	30	36	40	50	60	80	100	120	150	180	220	240	280	320	360	400	500	600	800	1000	1200	1500	2000
----	----	----	----	----	----	----	----	-----	-----	-----	-----	-----	-----	-----	-----	-----	-----	-----	-----	-----	------	------	------	------

Diameter in mm	Grit	Packing unit/pcs.	Cat. number
38	36	100	295174
38	60	100	295177
38	80	100	295178
38	120	100	295180
50	36	100	295196
50	40	100	295197
50	50	100	295198
50	60	100	295199
50	80	100	295200
50	100	100	295201
50	120	100	295202
50	180	100	295204
50	240	100	295205
50	320	100	295206
76	60	50	295221
76	80	50	295222
76	100	50	295223
76	120	50	295224
76	180	50	295226

Backing pad see page 169 / Adapter see page 174.

Other grits and sizes available on request.

Please observe: Minimum order quantities for manufactured items see page 164. Please see Applications Guide on page 162-165.

# Quick Change Discs

Quick Metal Connect



Quick Change Disc

## QMC 411

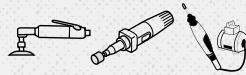
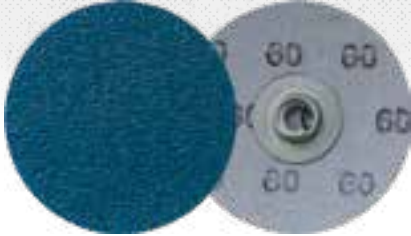

### Properties

Bonding agent	Resin
Grain	Zirconia alumina
Coating	Close

### Applications:

Stainless steel	●
Metals	●

**Advantages:** Aggressive abrasive behavior due to self-sharpening zirconia alumina - High removal rate on steel and stainless steel

### Available grits:

16	24	30	36	40	50	60	80	100	120	150	180	220	240	280	320	360	400	500	600	800	1000	1200	1500	2000
----	----	----	----	----	----	----	----	-----	-----	-----	-----	-----	-----	-----	-----	-----	-----	-----	-----	-----	------	------	------	------

Diameter in mm	Grit	Packing unit/pcs.	Cat. number
50	36	100	295300
50	40	100	295301
50	60	100	295303
50	80	100	295304
50	120	100	295305
76	36	50	295312
76	60	50	295315
76	80	50	295316

Backing pad see page 169 / Adapter see page 174.

Quick Change Disc

## QMC 409

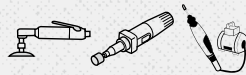
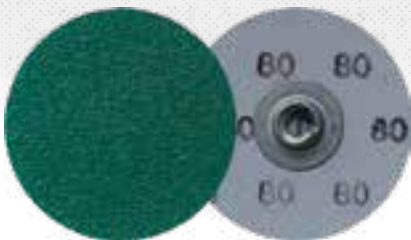

### Properties

Bonding agent	Resin
Grain	Zirconia alumina
Coating	Close

### Applications:

Stainless steel	●
Metals	●

**Advantages:** High removal rate on stainless steel - Multibond allows cool grinding on stainless steel - Minimal clogging on aluminium

### Available grits:

16	24	30	36	40	50	60	80	100	120	150	180	220	240	280	320	360	400	500	600	800	1000	1200	1500	2000
----	----	----	----	----	----	----	----	-----	-----	-----	-----	-----	-----	-----	-----	-----	-----	-----	-----	-----	------	------	------	------

Diameter in mm	Grit	Packing unit/pcs.	Cat. number
50	40	100	295335
50	60	100	295337
50	80	100	295338
50	120	100	295339

Backing pad see page 169 / Adapter see page 174.

Other grits and sizes available on request.

Please observe: Minimum order quantities for manufactured items see page 164. Please see Applications Guide on page 162-165.



# Quick Change Discs

Quick Metal Connect

Quick Change Disc

## QMC 910

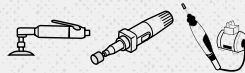

### Properties

Bonding agent	Resin
Grain	Ceramic Al. oxide
Coating	Close

### Applications:

Stainless steel	●
High alloy steel	●

**Advantages:** Extremely high removal rate on stainless steel due to micro-crystalline and self-sharpening ceramic grit - Continuously aggressive abrasive properties - Multibond allows cool grinding on stainless steel

### Available grits:

16	24	30	36	40	50	60	80	100	120	150	180	220	240	280	320	360	400	500	600	800	1000	1200	1500	2000
----	----	----	----	----	----	----	----	-----	-----	-----	-----	-----	-----	-----	-----	-----	-----	-----	-----	-----	------	------	------	------

Diameter in mm	Grit	Packing unit/pcs.	Cat. number
38	60	100	295359
38	80	100	295360
50	36	100	295366
50	40	100	295367
50	60	100	295369
50	80	100	295370

Backing pad see page 169 / Adapter see page 174.

Quick Change Disc

## QMC 400

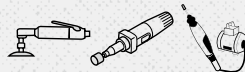

### Properties

Bonding agent	Resin
Grain	Aluminium oxide

### Applications:

Paint/Varnish/Filler	●
Metals	◐

**Advantages:** Suitable for surface finishing work - For cleaning work on metals and painted surfaces

Diameter in mm	Colour	Grade	Packing unit/pcs.	Cat. number
50	bordeaux	medium	50	295392
50	bordeaux	fine	50	295393
50	bordeaux	very fine	50	295394

Backing pad see page 169 / Adapter see page 174. Information regarding grit range see chart on page 173.

Other grits/grades and sizes available on request.

Please observe: Minimum order quantities for manufactured items see page 164. Please see Applications Guide on page 162-165.

Quick Change Disc

## QMC 800

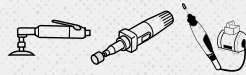

### Properties

Bonding agent Resin	
Grain	Aluminium oxide

### Applications:

Metals	●
Paint/Varnish/Filler	⓪

**Advantages:** For light deburring - For removal of rust and paint - Long life due to hard, stable quality of non-woven web material

Diameter in mm	Colour	Grade	Packing unit/pcs.	Cat. number
50	brown	coarse	50	295410
50	maroon	medium	50	295411
50	blue	very fine	50	295412
76	brown	coarse	25	295416
76	maroon	medium	25	295417
76	blue	very fine	25	295418

Backing pad see page 169 / Adapter see page 174. Information regarding grit range see chart on page 173.

Backing pad

## QMC 555

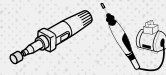

**Advantages:** For secure mounting of QMC discs - Optimized abrasive properties (aggressiveness, surface quality) due to three hardnesses

Diameter x Shaft in mm	Density	Colour	Max. RPM	Packing unit/pcs.	Cat. number
25 x 6	soft	grey	30000 rpm	1	300056
25 x 6	medium	blue	30000 rpm	1	295422
38 x 6	soft	grey	30000 rpm	1	300058
38 x 6	medium	blue	30000 rpm	1	295424
38 x 6	firm	red	30000 rpm	1	300059
50 x 6	soft	grey	30000 rpm	1	300060
50 x 6	medium	blue	30000 rpm	1	295426
50 x 6	firm	red	30000 rpm	1	295427
76 x 6	soft	grey	20000 rpm	1	300061
76 x 6	medium	blue	20000 rpm	1	295430
76 x 6	firm	red	20000 rpm	1	295431

Other grits/grades and sizes available on request.

Please observe: Minimum order quantities for manufactured items see page 164. Please see Applications Guide on page 162-165.

# Quick Change Discs

Quick Roll Connect

Quick Change Disc

## QRC 412

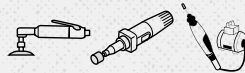

### Properties

Bonding agent	Resin
Grain	Aluminium oxide
Coating	Close

### Applications:

Metals	●
NF metals	●

**Advantages:** For universal use in coarse and intermediate grinding

### Available grits:

16	24	30	36	40	50	60	80	100	120	150	180	220	240	280	320	360	400	500	600	800	1000	1200	1500	2000
----	----	----	----	----	----	----	----	-----	-----	-----	-----	-----	-----	-----	-----	-----	-----	-----	-----	-----	------	------	------	------

Diameter in mm	Grit	Packing unit/pcs.	Cat. number
50	36	100	295207
50	40	100	295208
50	60	100	295210
50	80	100	295211
50	120	100	295213
76	36	50	295229
76	60	50	295232
76	80	50	295233
76	120	50	295235

Backing pad see page 174 / Adapter see page 174.

Quick Change Disc

## QRC 411

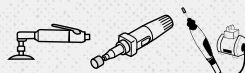

### Properties

Bonding agent	Resin
Grain	Zirconia alumina
Coating	Close

### Applications:

Stainless steel	●
Metals	●

**Advantages:** Aggressive abrasive behavior due to self-sharpening zirconia alumina - High removal rate on steel and stainless steel

### Available grits:

16	24	30	36	40	50	60	80	100	120	150	180	220	240	280	320	360	400	500	600	800	1000	1200	1500	2000
----	----	----	----	----	----	----	----	-----	-----	-----	-----	-----	-----	-----	-----	-----	-----	-----	-----	-----	------	------	------	------

Diameter in mm	Grit	Packing unit/pcs.	Cat. number
50	36	100	295306
50	40	100	295307
50	60	100	295309
50	80	100	295310

Other grits and sizes available on request.

Continuation →

Please observe: Minimum order quantities for manufactured items see page 164. Please see Applications Guide on page 162-165.

# Quick Change Discs

Quick Roll Connect



→ Continuation of QRC 411, Quick Change Disc

Diameter in mm	Grit	Packing unit/pcs.	Cat. number
50	120	100	295311
76	36	50	295318
76	60	50	295321
76	80	50	295322

Backing pad see page 174 / Adapter see page 174.

Quick Change Disc

## QRC 409

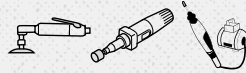

### Properties

Bonding agent	Resin
Grain	Zirconia alumina
Coating	Close

### Applications:

Stainless steel	●
Metals	●

**Advantages:** High removal rate on stainless steel - Multibond allows cool grinding on stainless steel - Minimal clogging on aluminium

Available grits:

16	24	30	36	40	50	60	80	100	120	150	180	220	240	280	320	360	400	500	600	800	1000	1200	1500	2000
----	----	----	----	----	----	----	----	-----	-----	-----	-----	-----	-----	-----	-----	-----	-----	-----	-----	-----	------	------	------	------

Diameter in mm	Grit	Packing unit/pcs.	Cat. number
50	36	100	295340
50	60	100	295343
50	80	100	295344

Backing pad see page 174 / Adapter see page 174.

Other grits and sizes available on request.

Please observe: Minimum order quantities for manufactured items see page 164. Please see Applications Guide on page 162-165.

# Quick Change Discs

Quick Roll Connect

Quick Change Disc

## QRC 910

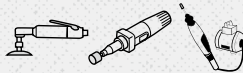

### Properties

Bonding agent	Resin
Grain	Ceramic Al. oxide
Coating	Close

### Applications:

Stainless steel	●
High alloy steel	●

**Advantages:** Extremely high removal rate on stainless steel due to micro-crystalline and self-sharpening ceramic - Continuously aggressive abrasive properties - Multibond allows cool grinding on stainless steel

### Available grits:

16	24	30	36	40	50	60	80	100	120	150	180	220	240	280	320	360	400	500	600	800	1000	1200	1500	2000
----	----	----	----	----	----	----	----	-----	-----	-----	-----	-----	-----	-----	-----	-----	-----	-----	-----	-----	------	------	------	------

Diameter in mm	Grit	Packing unit/pcs.	Cat. number
50	40	100	295372
50	60	100	295374
50	80	100	295375

Backing pad see page 174 / Adapter see page 174.

Quick Change Disc

## QRC 400

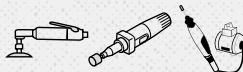
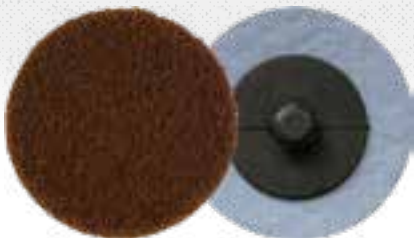

### Properties

Bonding agent	Resin
Grain	Aluminium oxide

### Applications:

Paint/Varnish/Filler	●
Metals	●

**Advantages:** Suitable for surface finishing work - For cleaning work on metals and painted surfaces

All sizes and minimum purchasing quantities available on request

Backing pad see page 174 / Adapter see page 174. Information regarding grit range see chart on page 173.

Other grits and sizes available on request.

Please observe: Minimum order quantities for manufactured items see page 164. Please see Applications Guide on page 162-165.

# Quick Change Discs

Quick Roll Connect



Quick Change Disc

## QRC 800

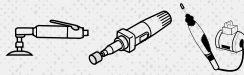

### Properties

Bonding agent Resin	
Grain	Aluminium oxide

### Applications:

Metals	●
Paint/Varnish/Filler	⓪

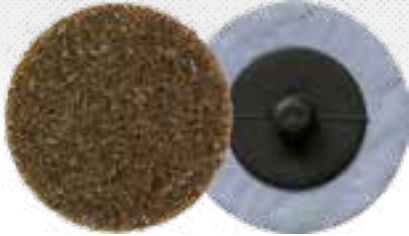

**Advantages:** For light deburring - For removal of rust and paint - Long life due to hard, stable quality of non-woven web material

Diameter in mm	Colour	Grade	Packing unit/pcs.	Cat. number
50	brown	coarse	50	295413
50	maroon	medium	50	295414
50	blue	very fine	50	295415
76	brown	coarse	25	295419
76	maroon	medium	25	295420

Backing pad see page 174 / Adapter see page 174.

Grit	60 - 80	120 - 150	180 - 240
Grade	coarse	medium	very fine
Klingspor Quick Change Discs	coarse A - brown	medium A - maroon	very fine - blue

Aggressiveness decreasing ↓

Other grits/grades and sizes available on request.

Please observe: Minimum order quantities for manufactured items see page 164. Please see Applications Guide on page 162-165.



# Quick Change Discs

Backing pads / Adapter

Backing pad

## QRC 555

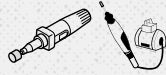

**Advantages:** For secure mounting of QRC discs - Optimized abrasive properties (aggressiveness, surface quality) due to two hardnesses

Diameter x Shaft in mm	Density	Colour	Max. RPM	Packing unit/pcs.	Cat. number
25 x 6	medium	blue	30000 rpm	1	295423
38 x 6	medium	blue	30000 rpm	1	295425
50 x 6	medium	blue	30000 rpm	1	295428
50 x 6	firm	red	30000 rpm	1	295429
76 x 6	medium	blue	20000 rpm	1	295432
76 x 6	firm	red	20000 rpm	1	295433

Adapter for quick change discs

## QCA 555



**Advantages:** Quick Change Disc adapter with M14 thread - Allows use of quick change discs on a regular angle grinder

Width x Length in mm	Thread/Shaft	Max. operating speed	Max. RPM	Packing unit/pcs.	Cat. number
20 x 30	thread M14	80 m/s	75400 rpm	1	308693



---

A large grid of small dots for taking notes.



# Abrasive mop wheels

## About the product

Developed by Klingspor over 40 years ago the abrasive mop wheel has found many practical and economical uses in surface finishing work. The Klingspor abrasive mop wheel comprises of high quality grinding flaps coated with aluminium oxide. The fan-shaped radial arrangement is firmly anchored by a resin core at the centre of the abrasive mop wheel. The structure of the abrasive mop wheel provides for very soft, comfortable grinding behaviour and adapts optimally to the contours of the workpiece. Klingspor abrasive mop wheels are especially suited for achieving a very smooth surface finish.

Klingspor has the perfect abrasive mop wheel to suit every surface, ranging from even to profiled surfaces, and is suited for nearly every material.

## Machines

Klingspor abrasive mop wheels can, depending on the dimensions, be used with the following machines:



Die grinders



Angle grinders



Flexible shafts



Drilling machines



Floor stand grinders



Satin finishing machine

Type	Page	Material applications														Machine applications								
		Metal	Apparatus / container engineering	Precision engineering	Mould making	Fittings	Pipes	Profiled sections	Tools	Mountings	Cutlery	Wood	Contoured wood	Model construction	Profiled sections	Paint / varnish / fillers	Plastics	Flexible shafts	Drilling machines	Die grinders	Automatic grinders	Floor stand grinders	Angle grinders	Satin finishing machine
SM 611	182	●	●	●	●	●	●	●	●	●	●	●	●	●	●	●	●	●	●	●	●	●	●	●
SM 611 W	183	●	●	●	●	●	●	●	●	●	●	●	●	●	●	●	●	●	●	●	●	●	●	●
SM 611 H	184	●	●	●	●	●	●	●	●	●	●	●	●	●	●	●	●	●	●	●	●	●	●	●
SM 611 S	189	●	●				●																	●
MM 630	186	●	○		○		○	○			●	●	●	●	●	○	●	●	●		●	●	●	●
MM 650	184	●	●	○	○	○	○	●		○	●	●	●	●	●	○	●	●	●	●	●	●	●	●
WSM 617	187	●	●	●	●	●	●	●	●	●	○	○	●	●	●	●	○	●	●	●	●	●	●	●
FSR 618	186	●	○	●	●	●	●	●	●	●	○	○	○	○	○	○	○	●	●	●	●	●	●	●
NCW 600	188	●	●	●	●	●	●	●	●	●						○	●	●	●					
NFW 600	188	●	●	●	●	●	●	●	●	●														
NCW 600 S	189	●	●				●																	●
NFW 600 S	190	●	●				●																	●

● = main application ○ = possible application



# Abrasive mop wheels

## Applications guide

### Mounting

#### **Abrasive mop wheels SM 611, MM 650, Abrasive cloth mop wheels NCW/NFW 600**

These abrasive mop wheels are mounted to the machine spindle with two SMD 612 mounting plates.

#### **Correct mounting is important**

To ensure that the abrasive mop wheel runs smoothly, please check that the mounting plates are mounted evenly and fit tightly to the inner edge of the metal side mounting plate retaining groove. The mounting plates are equipped with mounting bore holes. Making bore hole adjustments to fit the respective shaft diameter easy and quick – by simply drilling the appropriate bore hole diameter. Please refer to product text SMD 612 for more information on maximum bore hole diameters.

**The special abrasive mop and finishing mop models listed below are designed in such a way that they can be fitted on top of the respective machine shafts without any additional SMD 612 clamping brackets.**

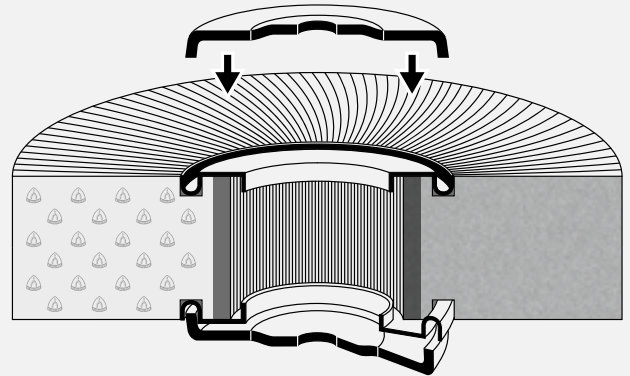

#### **Abrasive mop wheel SM 611 H**

The abrasive mop wheel with a wooden core is preferred for work on floor stand grinders with cone-shaped mounting spindles. It can be mounted directly on the machine spindle without the use of a mounting plate. Abrasive mop wheel SM 611 H is equipped with a  $\varnothing$  13 mm bore hole. Making bore hole adjustments to fit the respective shaft diameter easy and quick - by simply drilling the appropriate bore hole diameter.



#### **Abrasive mop wheel SM 611 W**

This abrasive mop wheel is equipped with a  $\varnothing$  25.4 mm mounting bore hole and can be mounted to a machine without the use of a mounting plate.



#### **WSM 617**

WSM 617 is a second generation abrasive mop wheel with integrated M14 and 5/8" internal threads. This wheel can be mounted and demounted to an angle grinder without the use of any additional tools.



#### **Abrasive flap drum SM 611 S, Abrasive mop drum NCW / NFW 600 S**

These drums are equipped with mounting bore holes starting from 19 mm for all standard satin finishing machines with the corresponding machine spindles.

# Abrasive mop wheels

Applications guide



## Minimum order quantities for made to order items

Product	Diameter in mm	Minimum order quantities
<b>SM 611</b>	100–165	20 pieces
<b>SM 611 W/H/S*</b>	200–300	10 pieces
<b>WSM 617*</b>	350–410	4 pieces
	100–165	20 pieces
<b>NFW 600 / NCW 600</b>	200–300	10 pieces
	350–410	4 pieces

\* Available dimensions on request

Product	Diameter in mm	Minimum order quantities
	165	20 pieces
<b>FSR 618</b>	200–300	10 pieces
	350–400	4 pieces
	100–165	20 pieces
<b>MM 650</b>	200–300	10 pieces
	>300	4 pieces

## The surface scratch pattern

The abrasive mop wheel's construction makes it perfect for achieving a smooth surface finish.

The abrasive mop wheel achieves a significantly smoother surface finish compared to that of a belt grinder. When choosing a grit size please select a grit size that is 2-3 sizes coarser than that used with a belt grinder.



### Abrasive belt 40 grit

- ▶ short distinctive line pattern
- ▶ rough surface
- ▶ high contrast finish



### Abrasive mop wheel 40 grit

- ▶ long continuous line pattern
- ▶ minimum depression
- ▶ smooth finish

## Common profilings

Pre-profiled abrasive mop wheels are designed to adapt perfectly to the contours of your individual workpiece and provide excellent results from the very beginning. Time consuming pre-profiling of the abrasive mop is no longer needed.

If you require an individualised abrasive mop wheel, we would be pleased to assist you with this.

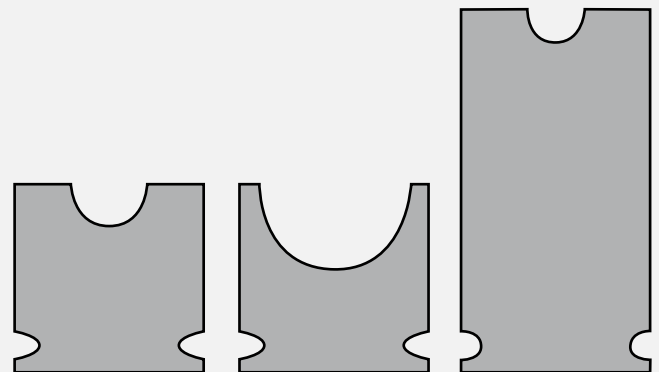



# Abrasive mop wheels

## Applications guide

### Selection of the correct mop diameter

To be able to work at the optimal cutting rate (38-42 m/s) the selection of the abrasive mop diameter for machines, that are not equipped with RPM setting functionality, is based on the set RPM. Machines that are equipped with RPM setting functionality are to be set according to the abrasive mop wheel diameter settings.

**Before turning the machine on please check that the pre-set RPM does not exceed the maximum abrasive mop RPM setting.**

Please refer to the adjoining table for the correct abrasive mop diameter settings for the optimal RPM range.

If the abrasive mop wheel is used at the optimal RPM setting, the grinding flaps stand up straight as result of the centrifugal forces around the core and provide optimum abrasive mop wheel grinding properties. Only the edges of the grinding flaps are subjected to wear and tear. This results in the use of new and sharper grits. This ensures uniform stock removal and surface finish – from the first to the last workpiece.

Suboptimal RPM settings (too low) result in the incorrect positioning of the grinding flap as a result of tool / grinding pressure. This results in wear and tear on the grit side of the grinding flaps, and the area the abrasive mop wheel grinds is too large, which in turn results in higher friction between the workpiece and the grinding flaps. Consequently the workpiece and abrasive mop wheel are subjected to a higher thermal load and a higher degree of wear and tear on the grinding flaps. Ultimately, this can result in the failure of the abrasive mop wheel and damaged grinding flaps.

#### Maximum RPM

Klingspor SM 611 abrasive mop wheels are certified for widths of ≤ 100 mm and maximum revolutions per minute of 50 m/s.

#### Optimal cutting rate

The abrasive mop wheel's optimum performance range is a cutting rate between 38-42 m/s.

Mop-Ø [mm]	Recommended RPM range [min-1] (38 - 42 m/s)
100	7,300–8,000
140	5,200–5,700
165	4,400–4,800
200	3,650–4,000
250	2,900–3,200
300	2,400–2,650
350	2,100–2,300
380	1,900–2,100
410	1,750–1,950
480	1,500–1,650
510	1,400–1,550

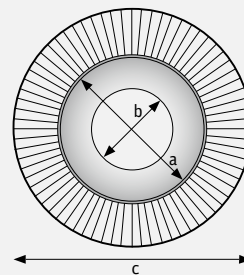

- a Outer diameter side cover
- b Hole side cover
- c Outer diameter mop

### Mop side cover and hole relative to the outer mop diameter\*

Type	Mop wheel outer Ø [mm]	Metal side cover		Matching clamping flange SMD 612
		Outer Ø [mm]	Hole [mm]	
SM 611	100 - 140	60	21,0	14821
	150 - 165	82	43,1	14823
	200 - 250	125	68,2	14824
	300	158	97,8	14826
	350	198	131,8	14827
	380 - 410	224	151,6	14829
	480 - 510	332	244,5	-
MM 650	250	82	43,1	14823
NCW/NFW 600	165	82	43,1	14823
	200	125	68,2	14824

\* applies to standard versions (stock items)

# Abrasive mop wheels

Applications guide



## Packet assembling

Another way to influence the grinding result is packet assembling. During packet assembling an intermediate layer is stamped between the cloth flaps. This creates space between the individual flaps, which influences the grinding behaviour of the wheel. The higher the ratio of grinding flaps to intermediate layers, the harder the abrasive mop wheel.

The standard abrasive mop wheel is manufactured without packet assembling.

Exception: Starting at a diameter of  $\geq 250$  mm, a width of  $\geq 50$  mm, and a grit size of 220 and finer, abrasive mop wheels are manufactured with a packet assembly ratio of 5:1.



5:1



3:1

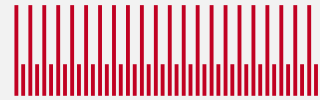

1:1

## Factors influencing the grinding result

The surface finish is dependent upon a wide range of process parameters. The table below illustrates the different influencing factors and their affect on the grinding result.

Influencing factor		Grinding result		
		Stock removal*	Surface finish	Service life
Cutting rate	high	increases	finer	shorter
	low	decreases	coarser	longer
Tool / grinding pressure	high	increases	coarser	shorter
	marginal	decreases	finer	longer
Grit size	rough	increases	coarser	shorter
	fine	decreases	finer	longer
Grinding aids (oils, lubricants)	without	increases	coarser	shorter
	with	decreases	finer	longer

\* Note: the essential parameters that affect the stock removal rate are the selection of a coarser (more stock removal) or finer (less stock removal) grit.

## The safe use of Klingspor abrasives

Klingspor abrasive mops are manufactured in accordance with the oSa and EN 13743 standards, this ensures the highest level of user safety.



Wear safety goggles or glasses to protect the eyes



Wear safety gloves to protect hands



Wear a dust mask



Observe safety instructions



Use ear muffs



Do not use for wet grinding

# Abrasive mop wheels

## Abrasive mop

Abrasive mop

### SM 611

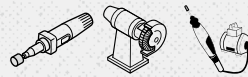

#### Properties

Bonding agent	Resin
Grain	Aluminium oxide

#### Applications:

Paint/Varnish/Filler	●
Wood	●
Plastic	●
Metals	●

**Advantages:** Even surface scratch pattern due to continuously fresh, unused abrasive grit - For universal use on all materials - Adapts optimally to workpiece contour

#### Available grits:

Diameter x Width x Bore in mm		Grit	Max. operating speed	Max. RPM	Packing unit/pcs.	Cat. number
100 x 30 x 21	40	50 m/s	9500 rpm	5	12000	
100 x 30 x 21	60	50 m/s	9500 rpm	5	12002	
100 x 30 x 21	80	50 m/s	9500 rpm	5	12003	
100 x 30 x 21	120	50 m/s	9500 rpm	5	12005	
100 x 30 x 21	180	50 m/s	9500 rpm	5	12007	
140 x 50 x 21	40	50 m/s	6800 rpm	3	12060	
140 x 50 x 21	60	50 m/s	6800 rpm	3	12062	
140 x 50 x 21	80	50 m/s	6800 rpm	3	12063	
140 x 50 x 21	120	50 m/s	6800 rpm	3	12065	
165 x 25 x 43,1	40	50 m/s	5800 rpm	5	12075	
165 x 25 x 43,1	60	50 m/s	5800 rpm	5	12077	
165 x 25 x 43,1	80	50 m/s	5800 rpm	5	12078	
165 x 25 x 43,1	100	50 m/s	5800 rpm	5	12079	
165 x 25 x 43,1	120	50 m/s	5800 rpm	5	12080	
165 x 25 x 43,1	150	50 m/s	5800 rpm	5	12081	
165 x 25 x 43,1	180	50 m/s	5800 rpm	5	12082	
165 x 25 x 43,1	240	50 m/s	5800 rpm	5	12084	
165 x 30 x 43,1	40	50 m/s	5800 rpm	5	12090	
165 x 30 x 43,1	60	50 m/s	5800 rpm	5	12092	
165 x 30 x 43,1	80	50 m/s	5800 rpm	5	12093	
165 x 30 x 43,1	120	50 m/s	5800 rpm	5	12095	
165 x 30 x 43,1	180	50 m/s	5800 rpm	5	12097	
165 x 50 x 43,1	40	50 m/s	5800 rpm	3	12105	
165 x 50 x 43,1	50	50 m/s	5800 rpm	3	12106	
165 x 50 x 43,1	60	50 m/s	5800 rpm	3	12107	
165 x 50 x 43,1	80	50 m/s	5800 rpm	3	12108	
165 x 50 x 43,1	100	50 m/s	5800 rpm	3	12109	
165 x 50 x 43,1	120	50 m/s	5800 rpm	3	12110	
165 x 50 x 43,1	150	50 m/s	5800 rpm	3	12111	
165 x 50 x 43,1	180	50 m/s	5800 rpm	3	12112	
165 x 50 x 43,1	240	50 m/s	5800 rpm	3	12114	
165 x 50 x 43,1	320	50 m/s	5800 rpm	3	12116	
200 x 25 x 68,2	120	50 m/s	4800 rpm	5	12140	
200 x 50 x 68,2	40	50 m/s	4800 rpm	3	12165	

Other grits and sizes available on request.

Continuation →

Please observe: Minimum order quantities for manufactured items see page 179. Please see Applications Guide on page 176-181.

# Abrasive mop wheels

## Abrasive mop



→ Continuation of SM 611, Abrasive mop

Diameter x Width x Bore in mm	Grit	Max. operating speed	Max. RPM	Packing unit/pcs.	Cat. number
200 x 50 x 68,2	60	50 m/s	4800 rpm	3	12167
200 x 50 x 68,2	80	50 m/s	4800 rpm	3	12168
200 x 50 x 68,2	120	50 m/s	4800 rpm	3	12170
250 x 25 x 68,2	60	50 m/s	3800 rpm	2	12197
250 x 25 x 68,2	80	50 m/s	3800 rpm	2	12198
250 x 25 x 68,2	120	50 m/s	3800 rpm	2	12200
250 x 30 x 68,2	60	50 m/s	3800 rpm	2	12212
250 x 30 x 68,2	80	50 m/s	3800 rpm	2	12213
250 x 30 x 68,2	240	50 m/s	3800 rpm	2	12219
250 x 50 x 68,2	40	50 m/s	3800 rpm	1	12225
250 x 50 x 68,2	60	50 m/s	3800 rpm	1	12227
250 x 50 x 68,2	80	50 m/s	3800 rpm	1	12228
250 x 50 x 68,2	120	50 m/s	3800 rpm	1	12230
250 x 50 x 68,2	180	50 m/s	3800 rpm	1	12232
250 x 50 x 68,2	220	50 m/s	3800 rpm	1	12233
250 x 50 x 68,2	240	50 m/s	3800 rpm	1	12234
250 x 50 x 68,2	320	50 m/s	3800 rpm	1	12236
300 x 50 x 97,8	40	50 m/s	3200 rpm	1	12285
300 x 50 x 97,8	80	50 m/s	3200 rpm	1	12288
300 x 50 x 97,8	120	50 m/s	3200 rpm	1	12290
300 x 50 x 97,8	180	50 m/s	3200 rpm	1	12292
300 x 50 x 97,8	240	50 m/s	3200 rpm	1	12294
300 x 50 x 97,8	320	50 m/s	3200 rpm	1	12296

Use only with mounting plate SMD 612 (page 185)!

Abrasive mop

## SM 611 W

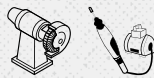

### Properties

Bonding agent	Resin
Grain	Aluminium oxide

### Applications:

Paint/Varnish/Filler	●
Wood	●
Plastic	●
Metals	●

**Advantages:** Even surface scratch pattern due to continuously fresh, unused abrasive grit - For universal use on all materials - Adapts optimally to workpiece contour - Can be used without mounting plate SMD 612

Available grits:

16 24 30 36 40 50 60 80 100 120 150 180 220 240 280 320 360 400 500 600 800 1000 1200 1500 2000

Diameter x Width x Bore in mm	Grit	Max. operating speed	Max. RPM	Packing unit/pcs.	Cat. number
165 x 25 x 25,4	40	50 m/s	5800 rpm	5	221597
165 x 25 x 25,4	60	50 m/s	5800 rpm	5	221596
165 x 25 x 25,4	80	50 m/s	5800 rpm	5	221595
165 x 25 x 25,4	120	50 m/s	5800 rpm	5	221593
165 x 25 x 25,4	180	50 m/s	5800 rpm	5	221591

Other grits and sizes available on request.

Please observe: Minimum order quantities for manufactured items see page 179. Please see Applications Guide on page 176-181.

# Abrasive mop wheels

## Abrasive mop

Abrasive mop

### SM 611 H

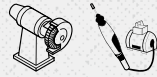

#### Properties

Bonding agent	Resin
Grain	Aluminium oxide

#### Applications:

Paint/Varnish/Filler	●
Wood	●
Plastic	●
Metals	●

**Advantages:** Wooden core with mounting bore diameter of 13 mm for fast mounting - Can be used without mounting plate SMD 612 - Enlargement of the mounting bore is relatively uncomplicated

#### Available grits:

16 24 30 36 40 50 60 80 100 120 150 180 220 240 280 320 360 400 500 600 800 1000 1200 1500 2000																					
Diameter x Width x Bore in mm	Grit	Max. operating speed	Max. RPM	Packing unit/pcs.	Cat. number																
165 x 25 x 13	40	50 m/s	5800 rpm	5	10030																
165 x 25 x 13	60	50 m/s	5800 rpm	5	10005																
165 x 25 x 13	80	50 m/s	5800 rpm	5	10004																
165 x 25 x 13	120	50 m/s	5800 rpm	5	10006																
165 x 25 x 13	240	50 m/s	5800 rpm	5	10027																
165 x 50 x 13	40	50 m/s	5800 rpm	3	10022																
165 x 50 x 13	60	50 m/s	5800 rpm	3	10017																
165 x 50 x 13	80	50 m/s	5800 rpm	3	10018																
165 x 50 x 13	120	50 m/s	5800 rpm	3	15990																

Abrasive mop

### MM 650



#### Properties

Bonding agent	Resin
Grain	Aluminium oxide

#### Applications:

Paint/Varnish/Filler	●
Wood	●
Metals	●
Plastic	○

**Advantages:** Very suitable for workpieces with high profiles due to grinding flaps with longitudinal slots - Produces a very fine surface

#### Available grits:

16 24 30 36 40 50 60 80 100 120 150 180 220 240 280 320 360 400 500 600 800 1000 1200 1500 2000																					
Diameter x Width x Bore in mm	Grit	Max. operating speed	Max. RPM	Packing unit/pcs.	Cat. number																
250 x 50 x 43,1	80	30 m/s	2300 rpm	2	2750																
250 x 50 x 43,1	100	30 m/s	2300 rpm	2	2486																
250 x 50 x 43,1	120	30 m/s	2300 rpm	2	2485																
250 x 50 x 43,1	150	30 m/s	2300 rpm	2	2483																

Other grits and sizes available on request.

Continuation →

Please observe: Minimum order quantities for manufactured items see page 179. Please see Applications Guide on page 176-181.

# Abrasive mop wheels

## Abrasive mop



→ Continuation of MM 650, Abrasive mop

Diameter x Width x Bore in mm	Grit	Max. operating speed	Max. RPM	Packing unit/pcs.	Cat. number
250 x 50 x 43,1	180	30 m/s	2300 rpm	2	2482
250 x 100 x 43,1	80	30 m/s	2300 rpm	1	10210
250 x 100 x 43,1	120	30 m/s	2300 rpm	1	2740
250 x 100 x 43,1	150	30 m/s	2300 rpm	1	2741
250 x 100 x 43,1	180	30 m/s	2300 rpm	1	2742

Use only with mounting plate SMD 612 (Cat. number 14823)!

Mounting plate

## SMD 612



**Advantages:** Ensures a smooth running and the safe mounting on the machine

Diameter x Bore in mm	Suitable for	Max. enlargement of bore Ø in mm	Packing unit/pcs.	Cat. number
55 x 10	SM 611 (Ø100+Ø140)	Ø 20 mm	2	14821
79 x 12	SM 611/NCW/NFW 600 (Ø150+Ø165)	Ø 40 mm	2	14823
121 x 14	SM 611/NCW/NFW 600 (Ø200+Ø250)	Ø 50 mm	2	14824
155 x 20	SM 611 (Ø300)	Ø 50 mm	2	14826
195 x 25	SM 611 (Ø350)	Ø 80 mm	2	14827
221 x 25,4	SM 611 (Ø380+Ø410)	Ø 80 mm	2	14829

Other grits and sizes available on request.

Please observe: Minimum order quantities for manufactured items see page 179. Please see Applications Guide on page 176-181.



# Abrasive mop wheels

## Abrasive mop

Abrasive mop

### MM 630

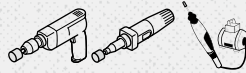

#### Properties

Bonding agent	Resin
Grain	Aluminium oxide

#### Applications:

Paint/Varnish/Filler	●
Wood	●
Metals	●
Plastic	◐

**Advantages:** Very suitable for workpieces with high profiles due to grinding flaps with longitudinal slots - For use on hand operated machines - Fine surface pattern

#### Available grits:

16 24 30 36 40 50 60 80 100 120 150 180 220 240 280 320 360 400 500 600 800 1000 1200 1500 2000																			
Diameter x Width x Shaft in mm	Grit	Max. operating speed	Max. RPM	Packing unit/pcs.	Cat. number														
180 x 25 x 6	80	40 m/s	4200 rpm	2	262630														
180 x 25 x 6	120	40 m/s	4200 rpm	2	262631														
180 x 25 x 6	180	40 m/s	4200 rpm	2	262632														
180 x 50 x 6	80	40 m/s	4200 rpm	2	262634														
180 x 50 x 6	120	40 m/s	4200 rpm	2	262635														
180 x 50 x 6	180	40 m/s	4200 rpm	2	262636														

Pleated mop

### FSR 618

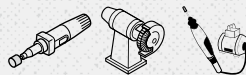

#### Properties

Bonding agent	Resin
Grain	Aluminium oxide

#### Applications:

Metals	●
Wood	◐
Paint/Varnish/Filler	◐
Plastic	◐

**Advantages:** Pleated mop wheel consisting of pleated aluminum oxide cloth flaps allows easy access to joints, grooves and slots - Very large immersion depth

#### Available grits:

16 24 30 36 40 50 60 80 100 120 150 180 220 240 280 320 360 400 500 600 800 1000 1200 1500 2000																			
Diameter x Bore in mm	Grit	Max. operating speed	Max. RPM	Packing unit/pcs.	Cat. number														
165 x 14	40	50 m/s	5800 rpm	10	10187														
165 x 14	60	50 m/s	5800 rpm	10	5830														
165 x 14	80	50 m/s	5800 rpm	10	5831														
165 x 14	120	50 m/s	5800 rpm	10	73994														
165 x 14	150	50 m/s	5800 rpm	10	25998														
165 x 14	220	50 m/s	5800 rpm	10	26033														

Other grits and sizes available on request.

Please observe: Minimum order quantities for manufactured items see page 179. Please see Applications Guide on page 176-181.

# Abrasive mop wheels

Abrasive mop



Angle grinder mop

## WSM 617



### Properties

Bonding agent Resin  
Grain Aluminium oxide

### Applications:

Steel	●	Wood	●
Stainless steel	●		
Paint	●		
Plastic	●		

**Advantages:** Can be used on all standard angle grinders (80 m/s) - For universal use; in front and side position - Easy tool changing by hand without additional aids

### Available grits:

16 24 30 36 40 50 60 80 100 120 150 180 220 240 280 320 360 400 500 600 800 1000 1200 1500 2000																				
Diameter x Width in mm	Grit	Thread/Shaft	Max. operating speed	Max. RPM	Packing unit/pcs.	Cat. number														
115 x 20	40	thread M14	80 m/s	13300 rpm	2	277014														
115 x 20	60	thread M14	80 m/s	13300 rpm	2	277015														
115 x 20	80	thread M14	80 m/s	13300 rpm	2	277016														
115 x 20	120	thread M14	80 m/s	13300 rpm	2	277017														
125 x 20	40	thread M14	80 m/s	12200 rpm	2	277018														
125 x 20	60	thread M14	80 m/s	12200 rpm	2	277019														
125 x 20	80	thread M14	80 m/s	12200 rpm	2	277020														
125 x 20	120	thread M14	80 m/s	12200 rpm	2	277021														



### The all-round abrasive mop wheel for the angle grinder

- Quick and easy mounting
- Multi purpose
- Extremely safe
- Ideal for working on hard-to-reach places

Other grits and sizes available on request.

Please observe: Minimum order quantities for manufactured items see page 179. Please see Applications Guide on page 176-181.

# Abrasive mop wheels

## Abrasive mop

Abrasive mop

### NCW 600

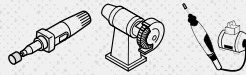

#### Properties

Bonding agent	Resin
Grain	Aluminium oxide

#### Applications:

Stainless steel	●
Metals	●
Plastic	○

**Advantages:** Combination of non-woven and abrasive cloth flaps for a fine surface scratch pattern - Optimal wear properties - High removal rate - Long service life

Diameter x Width x Bore in mm	Grit	Grade	Colour	Max. operating speed	Max. RPM	Packing unit/pcs.	Cat. number
165 x 50 x 43	80	coarse	maroon	32 m/s	3700 rpm	3	258909
165 x 50 x 43	100	medium	maroon	32 m/s	3700 rpm	3	258910
165 x 50 x 43	150	medium	maroon	32 m/s	3700 rpm	3	258911
165 x 50 x 43	180	very fine	maroon	32 m/s	3700 rpm	3	258912
200 x 50 x 68	80	coarse	maroon	32 m/s	3050 rpm	2	258913
200 x 50 x 68	100	medium	maroon	32 m/s	3050 rpm	2	258914
200 x 50 x 68	150	medium	maroon	32 m/s	3050 rpm	2	258915

Use only with mounting plate SMD 612 (page 185)!

Nylon webbed mop

### NFW 600

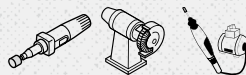

#### Properties

Bonding agent	Resin
Grain	Aluminium oxide

#### Applications:

Metals	●
Stainless steel	●

**Advantages:** Even finish throughout the entire service life - Optimal tool for creating a matt or satin finish

Diameter x Width x Bore in mm	Grade	Colour	Max. operating speed	Max. RPM	Packing unit/pcs.	Cat. number
165 x 50 x 43	coarse	maroon	32 m/s	3700 rpm	3	258898
165 x 50 x 43	medium	maroon	32 m/s	3700 rpm	3	258899
165 x 50 x 43	very fine	maroon	32 m/s	3700 rpm	3	258900
200 x 50 x 68	coarse	maroon	32 m/s	3050 rpm	2	258901
200 x 50 x 68	medium	maroon	32 m/s	3050 rpm	2	258902
200 x 50 x 68	very fine	maroon	32 m/s	3050 rpm	2	258903

Use only with mounting plate SMD 612 (page 185)!

Other grits and sizes available on request.

Please observe: Minimum order quantities for manufactured items see page 179. Please see Applications Guide on page 176-181.

Satin finishing drum

## SM 611 S



### Properties

Bonding agent	Resin
Grain	Aluminium oxide

### Applications:

Paint/Varnish/Filler	●
Wood	●
Plastic	●
Metals	●

**Advantages:** Even surface scratch pattern - Special product for fine surface finishing

Available grits:

16 24 30 36 40 50 60 80 100 120 150 180 220 240 280 320 360 400 500 600 800 1000 1200 1500 2000

Diameter x Width x Bore in mm	Grit	Max. operating speed	Max. RPM	Packing unit/pcs.	Cat. number
100 x 50 x 19	40	19 m/s	3700 rpm	3	60868
100 x 50 x 19	60	19 m/s	3700 rpm	3	60899
100 x 50 x 19	80	19 m/s	3700 rpm	3	60943
100 x 50 x 19	120	19 m/s	3700 rpm	3	61045
100 x 100 x 19	40	19 m/s	3700 rpm	1	83167
100 x 100 x 19	60	19 m/s	3700 rpm	1	7325
100 x 100 x 19	80	19 m/s	3700 rpm	1	7326
100 x 100 x 19	120	19 m/s	3700 rpm	1	93076
100 x 100 x 19	180	19 m/s	3700 rpm	1	93021
100 x 100 x 19	240	19 m/s	3700 rpm	1	104999

Satin finishing drum

## NCW 600 S

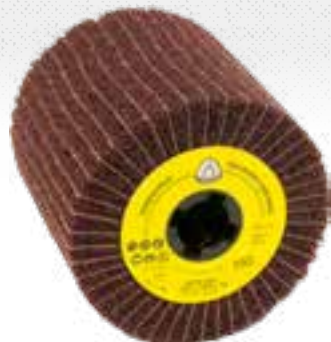

### Properties

Bonding agent	Resin
Grain	Aluminium oxide

### Applications:

Stainless steel	●
Metals	●
Plastic	○

**Advantages:** High removal rate and fine surface scratch pattern due to combination of non-woven and abrasive cloth flaps - Long service life

Diameter x Width x Bore in mm	Grit	Grade	Colour	Max. operating speed	Max. RPM	Packing unit/pcs.	Cat. number
100 x 50 x 19	80	coarse	maroon	19 m/s	3700 rpm	3	259896
100 x 50 x 19	100	medium	maroon	19 m/s	3700 rpm	3	259897
100 x 50 x 19	150	medium	maroon	19 m/s	3700 rpm	3	259898
100 x 50 x 19	180	very fine	maroon	19 m/s	3700 rpm	3	259899
100 x 100 x 19	80	coarse	maroon	19 m/s	3700 rpm	1	258905

Other grits and sizes available on request.

Please observe: Minimum order quantities for manufactured items see page 179. Please see Applications Guide on page 176-181.

Continuation →

# Satin finishing drums

→ Continuation of NCW 600 S, Satin finishing drum

Diameter x Width x Bore in mm	Grit	Grade	Colour	Max. operating speed	Max. RPM	Packing unit/pcs.	Cat. number
100 x 100 x 19	100	medium	maroon	19 m/s	3700 rpm	1	258906
100 x 100 x 19	150	medium	maroon	19 m/s	3700 rpm	1	258907
100 x 100 x 19	180	very fine	maroon	19 m/s	3700 rpm	1	258908
110 x 100 x 19	80	coarse	maroon	19 m/s	3300 rpm	1	320246
110 x 100 x 19	100	medium	maroon	19 m/s	3300 rpm	1	320247
110 x 100 x 19	150	medium	maroon	19 m/s	3300 rpm	1	320248
110 x 100 x 19	180	very fine	maroon	19 m/s	3300 rpm	1	320249

Satin finishing drum

## NFW 600 S



### Properties

Bonding agent	Resin
Grain	Aluminium oxide

### Applications:

Metals	●
Stainless steel	●

**Advantages:** Even finish throughout the entire service life - Optimal tool with high quality non-woven flaps for creating a matt or satin finish

Diameter x Width x Bore in mm	Grade	Colour	Max. operating speed	Max. RPM	Packing unit/pcs.	Cat. number
100 x 50 x 19	coarse	maroon	19 m/s	3700 rpm	3	259853
100 x 50 x 19	medium	maroon	19 m/s	3700 rpm	3	259854
100 x 50 x 19	very fine	maroon	19 m/s	3700 rpm	3	259895
100 x 100 x 19	coarse	maroon	19 m/s	3700 rpm	1	258895
100 x 100 x 19	medium	maroon	19 m/s	3700 rpm	1	258896
100 x 100 x 19	very fine	maroon	19 m/s	3700 rpm	1	258897
110 x 100 x 19	coarse	maroon	19 m/s	3300 rpm	1	320253
110 x 100 x 19	medium	maroon	19 m/s	3300 rpm	1	320254
110 x 100 x 19	very fine	maroon	19 m/s	3300 rpm	1	320255

Other grits and sizes available on request.

Please observe: Minimum order quantities for manufactured items see page 179. Please see Applications Guide on page 176-181.



---

A large grid of small dots for taking notes, consisting of approximately 30 columns and 40 rows of dots.



# Small abrasive mops

## About the product

The small abrasive mop comprises of grinding flaps coated with aluminium oxide. The fan-shaped abrasive flaps are securely fixed to a central mounting spindle. The grinding flaps' fan-shaped radial arrangement adapts perfectly to the contours of the workpiece.

The wide range of grits (40 – 320) and top size coat additives (with and without multibonds) make the Klingspor small abrasive mop perfect for a wide range of applications.

The small abrasive mop is equipped with the following standard features: a 6 mm or 3 mm fixing spindle and a shaft length of 40 mm.

## Application examples

- ▶ Grinding work for tool and mould making
- ▶ Processing of profiled workpieces
- ▶ Processing of internal surfaces on pipework, fittings and difficult-to-reach areas
- ▶ Grinding work on small parts and casing

Type	Material applications														Machine applications		Page		
	Metal	Apparatus / container engineering	Precision engineering	Mould making	Fittings	Pipes	Profiled sections	Tools	Mountings	Cutlery	Wood	Contoured wood	Model construction	Profiled sections	Plastics	Flexible shafts		Drilling machines	Die grinders
<i>KM 613</i>	●	●	●	●	●	●	●	●	●	●	○	○	○	○	○	●	●	●	194
<i>KM 615</i>	●	●	●	●	●	●	●	●	●	●			○	○		●	●	●	198
<i>KMT 614</i>	●	●	●	●	●	●	●	●	●	●	○	○	○	○	○	●	●	●	199
<i>NCS 600</i>	●	●	●	●	●	●	●	●	●	●					○	●	●	●	199
<i>NFS 600</i>	●	●	●	●	●	●	●	●	●	●						●	●	●	200

● = main application    ○ = possible application

## Minimum order quantities for made to order items

Product	Grit	Minimum order quantities
<i>KM 613</i>	40–320	250 pieces
	from 360	500 pieces
<i>KM 615</i>	40–180	250 pieces

Product	Grit	Minimum order quantities
<i>KMT 614</i>	40–320	250 pieces
	from 360	500 pieces
Product	Diameter in mm	Minimum order quantities
<i>NCS 600/ NFS 600</i>	30, 40, 50, 60	150 pieces
	80, 100	100 pieces

# Small abrasive mops

## Applications guide



## Application recommendations

- ▶ The small abrasive mop can be used with flexible shaft grinders, die grinders (pneumatic, electric) or drilling machines.
- ▶ The small abrasive mop's optimum performance is achieved at a cutting rate between 20 – 25 m/s. By observing these speeds, the product will perform at its most economical as regards tool wear, stock removal, surface finish and thermal load of the workpiece.

## Factors influencing the grinding result

### Stock removal

An increase in stock removal should only occur as a result of using coarser grit and not as a result of increased tool / grinding pressure.

Steady increased tool / grinding pressure

- ▶ results in unnecessary tool wear and tear
- ▶ results in increased workpiece temperature load
- ▶ can result in tool failure

### Surface finish

- ▶ The wear of the outer edge of the grinding flaps results in the presentation of new sharp abrasive grain, which results in a uniform surface finish
- ▶ The surface roughness decreases through an increase in the cutting rate
- ▶ An increase in the tool / grinding pressure results in a coarser surface finish
- ▶ The small abrasive mop achieves a significantly smoother surface finish compared to that of a belt grinder

### Temperature load

- ▶ By reducing the tool / grinding pressure and the peripheral speeds the temperature load of the workpiece and the tool is reduced.

ø [mm]	Height [mm]	Maximum operating speed [m/s]*	RPM [1/min]		
			L <sub>0</sub> = 0 mm	L <sub>0</sub> = 10 mm	L <sub>0</sub> = 20 mm
10	≤ 15	40	76,300	55,000	35,000
15	≤ 25	40	50,500	37,000	28,000
20	≤ 20	40	38,150	28,600	21,900
25	≤ 15	40	30,500	22,900	17,500
30	≤ 15	40	25,400	19,000	14,600
40	≤ 20	40	19,000	14,300	10,900
50	≤ 30	40	15,200	11,400	8,700
60	≤ 40	40	12,700	9,500	7,300
	50	32	10,150	7,900	6,300
80	≤ 40	40	9,500	7,100	5,400
	50	32	7,650	6,000	4,800

\* for exposed shank length L<sub>0</sub>=0 mm

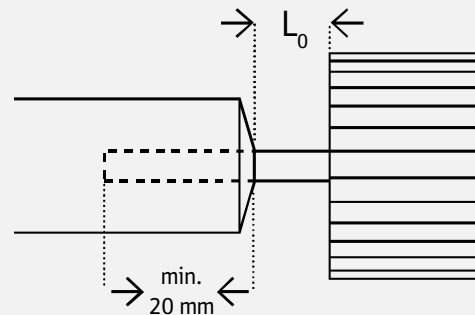

### Tool wear

Tool wear is reduced by working with a lower grinding pressure.

To ensure the optimal and most efficient use of a tool

- ▶ the maximum revolutions per minute may not be exceeded
- ▶ the fixing spindle length of the small abrasive mop in the mounting device must be at least 20 mm
- ▶ the set revolutions per minute may not be exceeded when using an exposed shaft length L<sub>0</sub> (please refer to the table above)

For additional information please refer to the safety information provided with the product.

# Small abrasive mop

Abrasive mop

Small abrasive mop

## KM 613

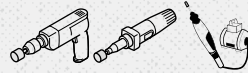

### Properties

Bonding agent	Resin
Grain	Aluminium oxide

### Applications:

Stainless steel	●
Metals	●
Wood	◐
Plastic	◐

**Advantages:** Universal product for steel and stainless steel materials - Even removal rate - Suitable for use in hard-to-reach areas

Available grits:

16	24	30	36	40	50	60	80	100	120	150	180	220	240	280	320	360	400	500	600	800	1000	1200	1500	2000
----	----	----	----	----	----	----	----	-----	-----	-----	-----	-----	-----	-----	-----	-----	-----	-----	-----	-----	------	------	------	------

Diameter x Width x Shaft in mm	Grit	Max. operating speed	Max. RPM	Packing unit/pcs.	Cat. number
10 x 10 x 3	40	40 m/s	76300 rpm	10	327992
10 x 10 x 3	60	40 m/s	76300 rpm	10	327993
10 x 10 x 3	80	40 m/s	76300 rpm	10	327994
10 x 10 x 3	120	40 m/s	76300 rpm	10	327995
10 x 10 x 3	180	40 m/s	76300 rpm	10	327997
10 x 10 x 3	240	40 m/s	76300 rpm	10	327998
10 x 10 x 3	320	40 m/s	76300 rpm	10	327999
20 x 10 x 3	40	40 m/s	38150 rpm	25	325947
20 x 10 x 3	60	40 m/s	38150 rpm	25	325948
20 x 10 x 3	80	40 m/s	38150 rpm	25	305324
20 x 10 x 3	120	40 m/s	38150 rpm	25	307342
20 x 10 x 3	180	40 m/s	38150 rpm	25	305888
20 x 10 x 3	240	40 m/s	38150 rpm	25	307343
20 x 10 x 3	320	40 m/s	38150 rpm	25	307344
20 x 10 x 6	40	40 m/s	38150 rpm	25	284729
20 x 10 x 6	60	40 m/s	38150 rpm	25	284730
20 x 10 x 6	80	40 m/s	38150 rpm	25	284731
20 x 10 x 6	120	40 m/s	38150 rpm	25	284732
20 x 10 x 6	180	40 m/s	38150 rpm	25	284733
20 x 10 x 6	240	40 m/s	38150 rpm	25	284734
20 x 10 x 6	320	40 m/s	38150 rpm	25	284735
20 x 15 x 6	40	40 m/s	38150 rpm	25	284736
20 x 15 x 6	60	40 m/s	38150 rpm	25	284737
20 x 15 x 6	80	40 m/s	38150 rpm	25	284738
20 x 15 x 6	120	40 m/s	38150 rpm	25	284739
20 x 15 x 6	180	40 m/s	38150 rpm	25	284740
20 x 15 x 6	240	40 m/s	38150 rpm	25	284741
20 x 20 x 6	40	40 m/s	38150 rpm	25	284743
20 x 20 x 6	60	40 m/s	38150 rpm	25	284744
20 x 20 x 6	80	40 m/s	38150 rpm	25	284745
20 x 20 x 6	120	40 m/s	38150 rpm	25	284746
20 x 20 x 6	180	40 m/s	38150 rpm	25	284747
20 x 20 x 6	240	40 m/s	38150 rpm	25	284748
20 x 20 x 6	320	40 m/s	38150 rpm	25	284749

Other grits and sizes available on request.

Continuation →

Please observe: Minimum order quantities for manufactured items see page 192. Please see Applications Guide on page 192-193.

# Small abrasive mop

## Abrasive mop



→ Continuation of KM 613, Small abrasive mop

Diameter x Width x Shaft in mm	Grit	Max. operating speed	Max. RPM	Packing unit/pcs.	Cat. number
25 x 10 x 6	40	40 m/s	30500 rpm	10	253816
25 x 10 x 6	60	40 m/s	30500 rpm	10	253591
25 x 10 x 6	80	40 m/s	30500 rpm	10	253592
25 x 10 x 6	120	40 m/s	30500 rpm	10	253593
25 x 15 x 6	40	40 m/s	30500 rpm	10	253817
25 x 15 x 6	60	40 m/s	30500 rpm	10	250985
25 x 15 x 6	80	40 m/s	30500 rpm	10	237496
25 x 15 x 6	120	40 m/s	30500 rpm	10	253606
25 x 15 x 6	150	40 m/s	30500 rpm	10	253607
25 x 15 x 6	240	40 m/s	30500 rpm	10	253608
30 x 5 x 3	60	40 m/s	25400 rpm	10	12781
30 x 5 x 3	80	40 m/s	25400 rpm	10	12782
30 x 5 x 3	120	40 m/s	25400 rpm	10	12784
30 x 5 x 3	240	40 m/s	25400 rpm	10	12787
30 x 5 x 6	60	40 m/s	25400 rpm	10	12790
30 x 5 x 6	80	40 m/s	25400 rpm	10	12791
30 x 5 x 6	120	40 m/s	25400 rpm	10	12793
30 x 5 x 6	150	40 m/s	25400 rpm	10	12794
30 x 5 x 6	240	40 m/s	25400 rpm	10	12796
30 x 10 x 3	60	40 m/s	25400 rpm	10	12808
30 x 10 x 3	80	40 m/s	25400 rpm	10	12809
30 x 10 x 3	120	40 m/s	25400 rpm	10	12811
30 x 10 x 3	240	40 m/s	25400 rpm	10	12814
30 x 10 x 6	40	40 m/s	25400 rpm	10	12816
30 x 10 x 6	60	40 m/s	25400 rpm	10	12817
30 x 10 x 6	80	40 m/s	25400 rpm	10	12818
30 x 10 x 6	100	40 m/s	25400 rpm	10	12819
30 x 10 x 6	120	40 m/s	25400 rpm	10	12820
30 x 10 x 6	150	40 m/s	25400 rpm	10	12821
30 x 10 x 6	180	40 m/s	25400 rpm	10	12822
30 x 10 x 6	240	40 m/s	25400 rpm	10	12823
30 x 10 x 6	320	40 m/s	25400 rpm	10	12824
30 x 15 x 6	40	40 m/s	25400 rpm	10	12843
30 x 15 x 6	60	40 m/s	25400 rpm	10	12844
30 x 15 x 6	80	40 m/s	25400 rpm	10	12845
30 x 15 x 6	100	40 m/s	25400 rpm	10	12846
30 x 15 x 6	120	40 m/s	25400 rpm	10	12847
30 x 15 x 6	150	40 m/s	25400 rpm	10	12848
30 x 15 x 6	180	40 m/s	25400 rpm	10	12849
30 x 15 x 6	240	40 m/s	25400 rpm	10	12850
30 x 15 x 6	320	40 m/s	25400 rpm	10	12851
40 x 10 x 6	40	40 m/s	19000 rpm	10	12870
40 x 10 x 6	60	40 m/s	19000 rpm	10	12871
40 x 10 x 6	80	40 m/s	19000 rpm	10	12872
40 x 10 x 6	120	40 m/s	19000 rpm	10	12874
40 x 15 x 6	40	40 m/s	19000 rpm	10	12906
40 x 15 x 6	60	40 m/s	19000 rpm	10	12907
40 x 15 x 6	80	40 m/s	19000 rpm	10	12908
40 x 15 x 6	100	40 m/s	19000 rpm	10	12909
40 x 15 x 6	120	40 m/s	19000 rpm	10	12910
40 x 15 x 6	150	40 m/s	19000 rpm	10	12911

Other grits and sizes available on request.

Please observe: Minimum order quantities for manufactured items see page 192. Please see Applications Guide on page 192-193.

Continuation →

# Small abrasive mop

## Abrasive mop

→ Continuation of KM 613, Small abrasive mop

Diameter x Width x Shaft in mm	Grit	Max. operating speed	Max. RPM	Packing unit/pcs.	Cat. number
40 x 15 x 6	180	40 m/s	19000 rpm	10	12912
40 x 15 x 6	240	40 m/s	19000 rpm	10	12913
40 x 15 x 6	320	40 m/s	19000 rpm	10	12914
40 x 20 x 6	40	40 m/s	19000 rpm	10	12942
40 x 20 x 6	60	40 m/s	19000 rpm	10	12943
40 x 20 x 6	80	40 m/s	19000 rpm	10	12944
40 x 20 x 6	100	40 m/s	19000 rpm	10	12945
40 x 20 x 6	120	40 m/s	19000 rpm	10	12946
40 x 20 x 6	150	40 m/s	19000 rpm	10	12947
40 x 20 x 6	180	40 m/s	19000 rpm	10	12948
40 x 20 x 6	240	40 m/s	19000 rpm	10	12949
40 x 20 x 6	320	40 m/s	19000 rpm	10	12950
50 x 5 x 6	60	40 m/s	15200 rpm	10	135235
50 x 5 x 6	80	40 m/s	15200 rpm	10	136451
50 x 5 x 6	120	40 m/s	15200 rpm	10	251778
50 x 10 x 6	40	40 m/s	15200 rpm	10	12960
50 x 10 x 6	60	40 m/s	15200 rpm	10	12961
50 x 10 x 6	80	40 m/s	15200 rpm	10	12962
50 x 10 x 6	120	40 m/s	15200 rpm	10	12964
50 x 10 x 6	150	40 m/s	15200 rpm	10	12965
50 x 10 x 6	240	40 m/s	15200 rpm	10	12967
50 x 15 x 6	40	40 m/s	15200 rpm	10	12978
50 x 15 x 6	60	40 m/s	15200 rpm	10	12979
50 x 15 x 6	80	40 m/s	15200 rpm	10	12980
50 x 15 x 6	120	40 m/s	15200 rpm	10	12982
50 x 15 x 6	240	40 m/s	15200 rpm	10	12985
50 x 20 x 6	40	40 m/s	15200 rpm	10	12996
50 x 20 x 6	60	40 m/s	15200 rpm	10	12997
50 x 20 x 6	80	40 m/s	15200 rpm	10	12998
50 x 20 x 6	100	40 m/s	15200 rpm	10	12999
50 x 20 x 6	120	40 m/s	15200 rpm	10	13000
50 x 20 x 6	150	40 m/s	15200 rpm	10	13001
50 x 20 x 6	180	40 m/s	15200 rpm	10	13002
50 x 20 x 6	240	40 m/s	15200 rpm	10	13003
50 x 20 x 6	320	40 m/s	15200 rpm	10	13004
50 x 30 x 6	40	40 m/s	15200 rpm	10	61282
50 x 30 x 6	60	40 m/s	15200 rpm	10	61299
50 x 30 x 6	80	40 m/s	15200 rpm	10	61319
50 x 30 x 6	100	40 m/s	15200 rpm	10	61333
50 x 30 x 6	120	40 m/s	15200 rpm	10	61350
50 x 30 x 6	150	40 m/s	15200 rpm	10	71015
50 x 30 x 6	180	40 m/s	15200 rpm	10	61371
50 x 30 x 6	240	40 m/s	15200 rpm	10	71017
50 x 30 x 6	320	40 m/s	15200 rpm	10	61389
60 x 15 x 6	40	40 m/s	12700 rpm	10	13014
60 x 15 x 6	60	40 m/s	12700 rpm	10	13015
60 x 15 x 6	80	40 m/s	12700 rpm	10	13016
60 x 15 x 6	120	40 m/s	12700 rpm	10	13018
60 x 15 x 6	150	40 m/s	12700 rpm	10	13019
60 x 15 x 6	240	40 m/s	12700 rpm	10	13021
60 x 20 x 6	40	40 m/s	12700 rpm	10	13032

Other grits and sizes available on request.

Continuation →

Please observe: Minimum order quantities for manufactured items see page 192. Please see Applications Guide on page 192-193.

# Small abrasive mop

Abrasive mop



→ Continuation of KM 613, Small abrasive mop

Diameter x Width x Shaft in mm	Grit	Max. operating speed	Max. RPM	Packing unit/pcs.	Cat. number
60 x 20 x 6	60	40 m/s	12700 rpm	10	13033
60 x 20 x 6	80	40 m/s	12700 rpm	10	13034
60 x 20 x 6	120	40 m/s	12700 rpm	10	13036
60 x 20 x 6	180	40 m/s	12700 rpm	10	13038
60 x 20 x 6	240	40 m/s	12700 rpm	10	13039
60 x 30 x 6	40	40 m/s	12700 rpm	10	13050
60 x 30 x 6	60	40 m/s	12700 rpm	10	13051
60 x 30 x 6	80	40 m/s	12700 rpm	10	13052
60 x 30 x 6	100	40 m/s	12700 rpm	10	13053
60 x 30 x 6	120	40 m/s	12700 rpm	10	13054
60 x 30 x 6	150	40 m/s	12700 rpm	10	13055
60 x 30 x 6	180	40 m/s	12700 rpm	10	13056
60 x 30 x 6	240	40 m/s	12700 rpm	10	13057
60 x 30 x 6	320	40 m/s	12700 rpm	10	13058
60 x 40 x 6	40	40 m/s	12700 rpm	10	13068
60 x 40 x 6	60	40 m/s	12700 rpm	10	13069
60 x 40 x 6	80	40 m/s	12700 rpm	10	13070
60 x 40 x 6	100	40 m/s	12700 rpm	10	13071
60 x 40 x 6	120	40 m/s	12700 rpm	10	13072
60 x 40 x 6	150	40 m/s	12700 rpm	10	13073
60 x 40 x 6	240	40 m/s	12700 rpm	10	13075
60 x 50 x 6	40	32 m/s	10150 rpm	10	13086
60 x 50 x 6	60	32 m/s	10150 rpm	10	13087
60 x 50 x 6	80	32 m/s	10150 rpm	10	13088
60 x 50 x 6	120	32 m/s	10150 rpm	10	13090
60 x 50 x 6	180	32 m/s	10150 rpm	10	13092
80 x 15 x 6	40	40 m/s	9500 rpm	10	13104
80 x 15 x 6	60	40 m/s	9500 rpm	10	13105
80 x 15 x 6	80	40 m/s	9500 rpm	10	13106
80 x 15 x 6	120	40 m/s	9500 rpm	10	13108
80 x 15 x 6	150	40 m/s	9500 rpm	10	13109
80 x 15 x 6	240	40 m/s	9500 rpm	10	13111
80 x 20 x 6	40	40 m/s	9500 rpm	10	13122
80 x 20 x 6	60	40 m/s	9500 rpm	10	13123
80 x 20 x 6	80	40 m/s	9500 rpm	10	13124
80 x 20 x 6	120	40 m/s	9500 rpm	10	13126
80 x 30 x 6	40	40 m/s	9500 rpm	10	13140
80 x 30 x 6	60	40 m/s	9500 rpm	10	13141
80 x 30 x 6	80	40 m/s	9500 rpm	10	13142
80 x 30 x 6	100	40 m/s	9500 rpm	10	13143
80 x 30 x 6	120	40 m/s	9500 rpm	10	13144
80 x 30 x 6	150	40 m/s	9500 rpm	10	13145
80 x 30 x 6	240	40 m/s	9500 rpm	10	13147
80 x 30 x 6	320	40 m/s	9500 rpm	10	13148
80 x 40 x 6	40	40 m/s	9500 rpm	10	13158
80 x 40 x 6	60	40 m/s	9500 rpm	10	13159
80 x 40 x 6	80	40 m/s	9500 rpm	10	13160
80 x 40 x 6	120	40 m/s	9500 rpm	10	13162
80 x 50 x 6	40	32 m/s	7650 rpm	10	13176
80 x 50 x 6	60	32 m/s	7650 rpm	10	13177
80 x 50 x 6	80	32 m/s	7650 rpm	10	13178

Other grits and sizes available on request.

Continuation →

Please observe: Minimum order quantities for manufactured items see page 192. Please see Applications Guide on page 192-193.



# Small abrasive mop

## Abrasive mop

→ Continuation of KM 613, Small abrasive mop

Diameter x Width x Shaft in mm	Grit	Max. operating speed	Max. RPM	Packing unit/pcs.	Cat. number
80 x 50 x 6	100	32 m/s	7650 rpm	10	13179
80 x 50 x 6	120	32 m/s	7650 rpm	10	13180
80 x 50 x 6	150	32 m/s	7650 rpm	10	13181
80 x 50 x 6	240	32 m/s	7650 rpm	10	13183
80 x 50 x 6	320	32 m/s	7650 rpm	10	13184

Small abrasive mop

## KM 615

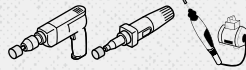

### Properties

Bonding agent Resin

Grain Aluminium oxide

### Applications:

Stainless steel ●

**Advantages:** Cool grinding due to multibond - Increased removal rate on stainless steel



Available grits:

16 24 30 36 40 50 60 80 100 120 150 180 220 240 280 320 360 400 500 600 800 1000 1200 1500 2000

Diameter x Width x Shaft in mm	Grit	Max. operating speed	Max. RPM	Packing unit/pcs.	Cat. number
30 x 10 x 6	60	40 m/s	25400 rpm	10	253615
30 x 10 x 6	80	40 m/s	25400 rpm	10	253620
30 x 10 x 6	120	40 m/s	25400 rpm	10	253610
40 x 20 x 6	60	40 m/s	19000 rpm	10	253616
40 x 20 x 6	80	40 m/s	19000 rpm	10	253621
40 x 20 x 6	120	40 m/s	19000 rpm	10	253611
50 x 20 x 6	60	40 m/s	15200 rpm	10	253617
60 x 30 x 6	60	40 m/s	12700 rpm	10	253618
60 x 30 x 6	80	40 m/s	12700 rpm	10	253623
80 x 40 x 6	60	40 m/s	9500 rpm	10	253619
80 x 40 x 6	80	40 m/s	9500 rpm	10	253624

Other grits and sizes available on request.

Please observe: Minimum order quantities for manufactured items see page 192. Please see Applications Guide on page 192-193.

# Small abrasive mop

Abrasive mop



Small abrasive mop, cup-shaped

## KMT 614

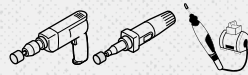

### Properties

Bonding agent Resin	
Grain	Aluminium oxide

### Applications:

Metals	●
Wood	⓪
Plastic	⓪

**Advantages:** Can be used in radial and front position

Available grits:

16	24	30	36	40	50	60	80	100	120	150	180	220	240	280	320	360	400	500	600	800	1000	1200	1500	2000
Diameter x Width x Shaft in mm		Grit	Max. operating speed	Max. RPM	Packing unit/pcs.	Cat. number																		
60 x 40 x 6		40	40 m/s	12700 rpm	10	13194																		
60 x 40 x 6		60	40 m/s	12700 rpm	10	13195																		

Small finishing mop

## NCS 600

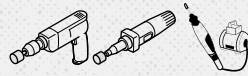

### Properties

Bonding agent Resin	
Grain	Aluminium oxide

### Applications:

Stainless steel	●
Metals	●
Plastic	⓪

**Advantages:** High removal rate and fine surface scratch pattern due to combination of non-woven and abrasive cloth flaps - Long service life

Diameter x Width x Shaft in mm	Grit	Grade	Colour	Max. operating speed	Max. RPM	Packing unit/pcs.	Cat. number
50 x 30 x 6	60	coarse	maroon	32 m/s	12200 rpm	10	258932
50 x 30 x 6	100	medium	maroon	32 m/s	12200 rpm	10	258933
50 x 30 x 6	150	medium	maroon	32 m/s	12200 rpm	10	258934
50 x 30 x 6	240	very fine	maroon	32 m/s	12200 rpm	10	258935
60 x 30 x 6	60	coarse	maroon	32 m/s	10200 rpm	10	258936
60 x 30 x 6	100	medium	maroon	32 m/s	10200 rpm	10	258937
60 x 30 x 6	150	medium	maroon	32 m/s	10200 rpm	10	258938
60 x 30 x 6	240	very fine	maroon	32 m/s	10200 rpm	10	258939
60 x 50 x 6	60	coarse	maroon	32 m/s	10200 rpm	10	258940
60 x 50 x 6	100	medium	maroon	32 m/s	10200 rpm	10	258941
60 x 50 x 6	150	medium	maroon	32 m/s	10200 rpm	10	258942
60 x 50 x 6	240	very fine	maroon	32 m/s	10200 rpm	10	258943
80 x 50 x 6	60	coarse	maroon	32 m/s	7600 rpm	10	258944

Other grits and sizes available on request.

Please observe: Minimum order quantities for manufactured items see page 192. Please see Applications Guide on page 192-193.

Continuation →

# Small abrasive mop

## Abrasive mop

→ Continuation of NCS 600, Small finishing mop

Diameter x Width x Shaft in mm	Grit	Grade	Colour	Max. operating speed	Max. RPM	Packing unit/pcs.	Cat. number
80 x 50 x 6	100	medium	maroon	32 m/s	7600 rpm	10	258945
80 x 50 x 6	150	medium	maroon	32 m/s	7600 rpm	10	258946
80 x 50 x 6	240	very fine	maroon	32 m/s	7600 rpm	10	258947
100 x 50 x 6	60	coarse	maroon	32 m/s	6100 rpm	4	258948
100 x 50 x 6	100	medium	maroon	32 m/s	6100 rpm	4	258949
100 x 50 x 6	150	medium	maroon	32 m/s	6100 rpm	4	258950
100 x 50 x 6	240	very fine	maroon	32 m/s	6100 rpm	4	258951

Small finishing mop

## NFS 600

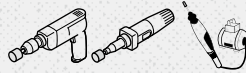

### Properties

Bonding agent	Resin
Grain	Aluminium oxide

### Applications:

Metals	●
Stainless steel	●

**Advantages:** Even finish throughout the entire service life - Optimal tool with high quality non-woven flaps for creating a matt or satin finish

Diameter x Width x Shaft in mm	Grade	Colour	Max. operating speed	Max. RPM	Packing unit/pcs.	Cat. number
50 x 30 x 6	coarse	maroon	32 m/s	12200 rpm	10	258917
50 x 30 x 6	medium	maroon	32 m/s	12200 rpm	10	258918
50 x 30 x 6	very fine	maroon	32 m/s	12200 rpm	10	258919
60 x 30 x 6	coarse	maroon	32 m/s	10200 rpm	10	258920
60 x 30 x 6	medium	maroon	32 m/s	10200 rpm	10	258921
60 x 30 x 6	very fine	maroon	32 m/s	10200 rpm	10	258922
60 x 50 x 6	coarse	maroon	32 m/s	10200 rpm	10	258923
60 x 50 x 6	medium	maroon	32 m/s	10200 rpm	10	258924
60 x 50 x 6	very fine	maroon	32 m/s	10200 rpm	10	258925
80 x 50 x 6	coarse	maroon	32 m/s	7600 rpm	10	258926
80 x 50 x 6	medium	maroon	32 m/s	7600 rpm	10	258927
80 x 50 x 6	very fine	maroon	32 m/s	7600 rpm	10	258928
100 x 50 x 6	coarse	maroon	32 m/s	6100 rpm	4	258929
100 x 50 x 6	medium	maroon	32 m/s	6100 rpm	4	258930
100 x 50 x 6	very fine	maroon	32 m/s	6100 rpm	4	258931

Other grits and sizes available on request.

Please observe: Minimum order quantities for manufactured items see page 192. Please see Applications Guide on page 192-193.







# Abrasive mop discs

## About the product

Since their market launch, the Klingspor abrasive mop disc has successfully taken the place of the grinding disc in many areas of surface finishing.























The performance of the abrasive mop disc, with its fan-shaped radial arrangement of cloth grinding flaps, far exceeds that of other abrasive products.

Klingspor abrasive mop discs are made of zirconia alumina, ceramic, or aluminium oxide coated flaps fastened to glass fibre-reinforced or plastic backing plates.

The even arrangement of the flaps guarantees high flexibility, constant high grinding performance and low vibrations.

## Minimum order quantities for made to order items

Diameter	Minimum order quantities
up to 150 mm	320 pieces
180 mm	160 pieces

Type		Material								Application						Page	
		Steel	Stainless steel	High alloy stainless steel	NF-metals	Aluminium	Wood	Plastics	Paint / varnish / filler	Finish grinding	Welded seam work	Edge work; bevelling	Concave fillet weld work	Rust and varnish removal	Heat tinting and oxide film removal		
<b>SMT 314 EXTRA</b>		●			●	●	○				●	●					208
<b>SMT 324 EXTRA</b>		●	●	●						●							209
<b>SMT 324 EXTRA</b>		●	●	●							●	●					209
<b>SMT 325 EXTRA</b>		●	●	●						●							210
<b>SMT 325 EXTRA</b>		●	●	●							●	●					210
<b>SMT 524 ACCU</b>		●	●	●							●	●					211
<b>SMT 624 SUPRA</b>		●	●	●							●	●					211
<b>SMT 626 SUPRA</b>		●	●	●							●	●					213
<b>SMT 628 SUPRA</b>		●	●	●						●							212
<b>SMT 636 SUPRA</b>			●	●	●	●				●							214
<b>SMT 636 SUPRA</b>			●	●	●	●					●	●					214
<b>SMT 644 SUPRA</b>		●	●	●						●							214
<b>SMT 644 SUPRA</b>		●	●	●							●	●					214
<b>SMT 645 SUPRA</b>		●	●	●						●							215
<b>SMT 688 SPECIAL</b>		●	●	●						●		●					218
<b>SMT 800 SPECIAL</b>			●	●						●				●	●		219
<b>SMT 850 plus SPECIAL</b>			●	●							●						219
<b>SMT 924 SPECIAL</b>		●	●								●	●					216
<b>SMT 925 SPECIAL</b>		●	●	●						●							216
<b>SMT 925 SPECIAL</b>		●	●	●							●	●					216
<b>SMT 926 SPECIAL</b>		●	●	●							●	●					217
<b>SMT 996 SPECIAL</b>			●	●						●							218
<b>SMT 996 SPECIAL</b>			●	●							●	●					218
<b>MFW 600</b>		●	●	●								●					220
<b>NCD 200</b>		●	○	●	●	●	●	●	●					●	●		221
<b>PW 2000</b>		●	●	●	●	●	●	●	●					●	●		221
<b>NUD 500</b>			●	●						●					●		220

● = main application ○ = possible application



# Abrasive mop discs

## Applications guide

### 1. Red bar

Label indicates the max. peripheral speed of 80 m/s

### 2. Safety recommendations

oSa label

### 3. Dimensions

Product dimensions in millimetre and inch

### 4. Punch ring

Manufacturer information, no expiry date

### 5. Grit size

### 6. Cat. number

### 7. Safety recommendations

Language neutral pictograms

### 8. Quality class

Extra/Supra/Special

### 9. Product name

Type



## Product groups

Klingspor offers three integrated product groups. For each user and application we offer the right abrasive mop disc. All abrasive mop discs are manufactured according to the applicable standards and guarantee the highest degree of safety.



### EXTRA

Ideal price-performance ratio for universal implementation. Excellent grinding results on different steel materials.



### SUPRA

Professional products with excellent service life and high stock removal rate. Aggressive grinding and long service life.



### SPECIAL

High performance products for special industrial and trade applications. High performance and service life even when used intensively.

# Abrasive mop discs

Applications guide



## Product structure

The three abrasive mop disc components are perfectly integrated to achieve maximum performance.

### 1. Grinding flaps

Klingspor has developed special coated abrasives for its abrasive mop discs. The grinding tool is perfect for use with high speed angle grinders (80 m/s) and corresponding applications. This ensures top grinding performance and long service life.

### 2. Backing plate

Klingspor uses two different backing plate types to produce abrasive mop discs. The first one is the most popular on the market made of glass fibre; the second one is made of plastic.

### 3. Glue

The glue (adhesive) is the joint between the backing plate and the grinding flaps. It ensures that the grinding flaps cannot come off the backing plate if used properly. It also ensures safety far above the guidelines of the oSa directives and the EN 13743 safety standard.

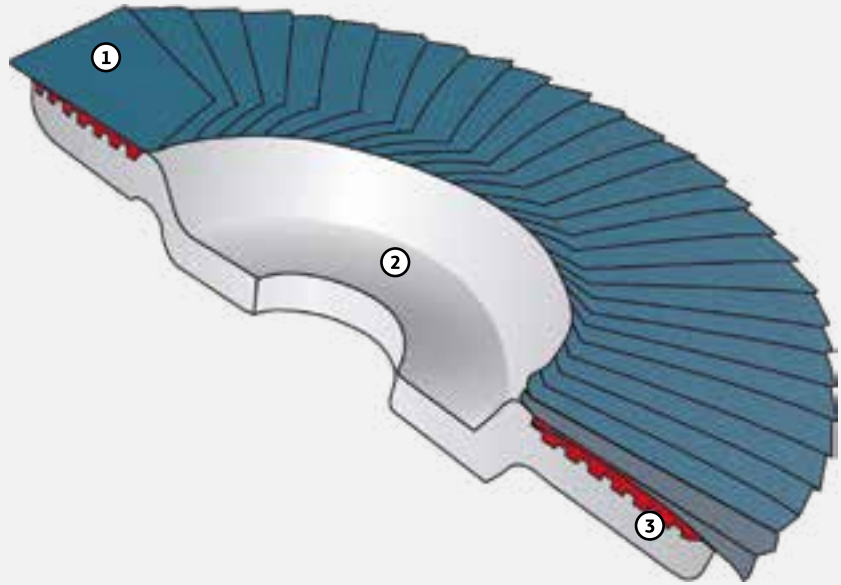

## Form

The convex abrasive mop disc grinds a narrower surface than the flat abrasive mop disc. The more selective use of the convex disc achieves a greater stock removal rate per time unit as compared to the flat mop disc. The convex abrasive mop disc is particularly suited to working on edges and welded seams. The flat disc is primarily used for flat and surface grinding.

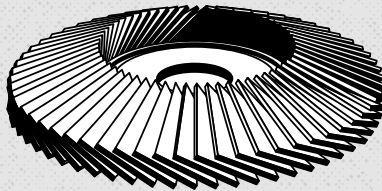

convex

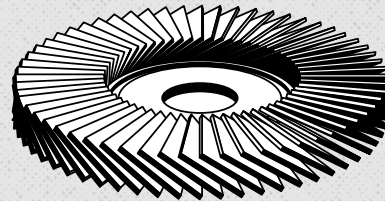

flat



# Abrasive mop discs

Applications guide

## Coated abrasives

Compared to belt applications the coated abrasives for abrasive mop discs withstand much higher loads. On the one hand, the cutting speed of abrasive mop discs is approximately 2 to 2.5 times faster than the cutting rate of a belt application, on the other hand the backing must wear down to ensure that new, unused grit is used. Klingspor has developed special coated abrasives specifically for this product group. These are developed specifically for high powered angle grinders (80 m/s) and ensures top grinding performance and long service life (see diagram).

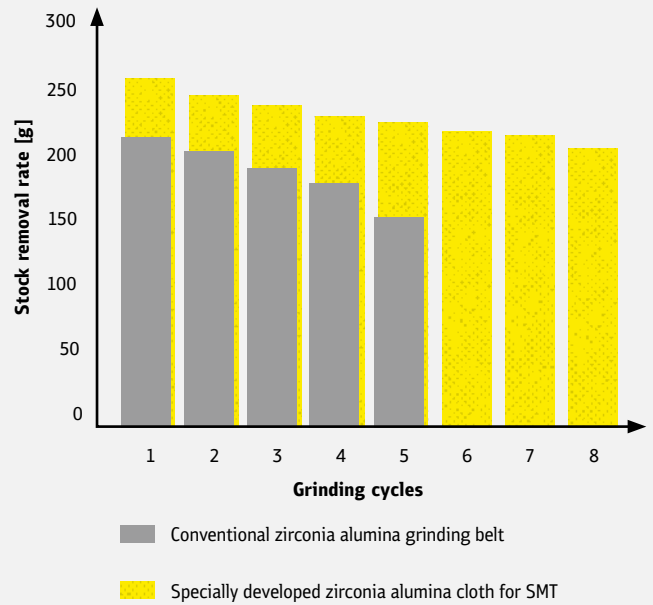

### 1. Zirconia alumina cloth

Zirconia alumina grit, heavy cotton polyester cloth, best performance with high power machines

### 2. Zirconia alumina cloth

Aggressive zirconia alumina grit, cotton cloth, good stock removal with angle grinders of all performance classes

### 3. Zirconia alumina + Multibond

Self-sharpening zirconia alumina grit, cotton backing, especially for cool grinding on stainless steel

### 4. Aluminium oxide cloth

Durable grit aluminium oxide, cotton cloth, for use with metal and NF-metals

### 5. Ceramic aluminium oxide + Multibond

Ceramic high performance grit, robust polyester backing high performance for stainless steel work, cool grinding on stainless steel surfaces

### 6. Ceramic aluminium oxide

Ceramic high performance grit, robust polyester backing, high performance for steel work



## The safe use of Klingspor abrasives

Klingspor abrasive mop discs are manufactured according to the oSa and EN13743 standards, this ensures the highest level of user safety.



Wear safety goggles or glasses to protect the eyes



Wear safety gloves to protect hands



Wear a dust mask



Observe safety instructions



Use ear muffs



Do not use for wet grinding



Correctly mounted





Incorrectly mounted



# Abrasive mop discs

SMT programme



		Steel / NF metals	Steel / INOX			Service life	Stainless Steel
		Aggression	Aggression				Aggression
<b>SPECIAL</b>	Type:		<b>SMT 924</b>		<b>SMT 925</b>	<b>SMT 926</b>	<b>SMT 996</b>
							
	Aggression:		■■■■■■■■		■■■■■■■■	■■■■■■■□	■■■■■■■■
	Service life:		■■■■■■■■		■■■■■■■□	■■■■■■■■	■■■■■■■□
	Backing plate:		Glass fibre		Plastic	Glass fibre	Glass fibre
Form:		convex (6°)		convex (12°) / flat	convex (6°)	convex (6°) / flat	
<b>SUPRA</b>	Type:		<b>SMT 644</b>				
							
	Aggression:		■■■■■■■□				
	Service life:		■■■■■■■□				
	Backing plate:		Glass fibre				
Form:		convex (12°) / flat					
<b>EXTRA</b>	Type:		<b>SMT 624</b>	<b>SMT 628</b>		<b>SMT 626</b>	<b>SMT 636</b>
							
	Aggression:		■■■■■■■□	■■■■■■■□		■■■■■■■□	■■■■■■■□
	Service life:		■■■■■■■□	■■■■■■■□		■■■■■■■□	■■■■■■■□
	Backing plate:		Glass fibre	Glass fibre		Glass fibre	Glass fibre
Form:		convex (12°)	flat		convex (6°)	convex (6°) / flat	
<b>EXTRA</b>	Type:	<b>SMT 314</b>	<b>SMT 324</b>		<b>SMT 325</b>		
							
	Aggression:	■■■■■□□□	■■■■■□□□		■■■■■□□□		
	Service life:	■■■■■□□□	■■■■■□□□		■■■■■□□□		
	Backing plate:	Glass fibre	Glass fibre		Plastic		
Form:	convex (12°)	convex (12°) / flat		convex (12°) / flat			

# Abrasive mop discs

Abrasive mop disc

## SMT 314 EXTRA



<b>Class</b>	EXTRA
Aggression	■ ■ ■ ■ □ □ □ □
Service life	■ ■ ■ ■ □ □ □ □



<b>Applications:</b>	
Steel	●
NF metals	●
Wood	○

<b>Properties</b>	
Grain	Aluminium oxide
Backing plate	Glass fibre
Design	Convex 12°

**Advantages:** Good stock removal rate on unalloyed steels - Also suitable for non-ferrous metals - Good removal rate on angle grinders of all performance classes

### Available grits:

16	24	30	36	40	50	60	80	100	120	150	180	220	240	280	320	360	400	500	600	800	1000	1200	1500	2000
Diameter x Bore in mm	Form	Grit	Max. operating speed	Max. RPM	Packing unit/pcs.	Cat. number																		
115 x 22,23		36	80 m/s	13300 rpm	10	322808																		
115 x 22,23		40	80 m/s	13300 rpm	10	322809																		
115 x 22,23		60	80 m/s	13300 rpm	10	322811																		
115 x 22,23		80	80 m/s	13300 rpm	10	322812																		
115 x 22,23		120	80 m/s	13300 rpm	10	322813																		
125 x 22,23		36	80 m/s	12200 rpm	10	322814																		
125 x 22,23		40	80 m/s	12200 rpm	10	322815																		
125 x 22,23		60	80 m/s	12200 rpm	10	322817																		
125 x 22,23		80	80 m/s	12200 rpm	10	322818																		
125 x 22,23		120	80 m/s	12200 rpm	10	322819																		
180 x 22,23		36	80 m/s	8500 rpm	10	322820																		
180 x 22,23		40	80 m/s	8500 rpm	10	322821																		
180 x 22,23		60	80 m/s	8500 rpm	10	322822																		
180 x 22,23		80	80 m/s	8500 rpm	10	322823																		

Please observe: Minimum order quantities for manufactured items see page 203. Please see Applications Guide on page 202-207.

Abrasive mop disc

## SMT 324 EXTRA



<b>Class</b>	EXTRA
Aggression	■ ■ ■ ■ ■ □ □
Service life	■ ■ ■ ■ □ □ □













<b>Applications:</b>	
Stainless steel	●
Steel	●



<b>Properties</b>	
Grain	Zirconia alumina
Backing plate	Glass fibre
Design	Convex 12°, flat

**Advantages:** Universal product for edges and surface work on steel and stainless steel - Good removal rate on angle grinders of all performance classes - No glazing, also under low grinding pressure

### Available grits:

16	24	30	36	40	50	60	80	100	120	150	180	220	240	280	320	360	400	500	600	800	1000	1200	1500	2000
Diameter x Bore in mm	Form	Grit	Max. operating speed	Max. RPM	Packing unit/pcs.	Cat. number																		
115 x 22,23		40	80 m/s	13300 rpm	10	321509																		
115 x 22,23		60	80 m/s	13300 rpm	10	321511																		
115 x 22,23		80	80 m/s	13300 rpm	10	321513																		
115 x 22,23		40	80 m/s	13300 rpm	10	321645																		
115 x 22,23		60	80 m/s	13300 rpm	10	321647																		
115 x 22,23		80	80 m/s	13300 rpm	10	321649																		
125 x 22,23		40	80 m/s	12200 rpm	10	321510																		
125 x 22,23		60	80 m/s	12200 rpm	10	321512																		
125 x 22,23		80	80 m/s	12200 rpm	10	321514																		
125 x 22,23		40	80 m/s	12200 rpm	10	321646																		
125 x 22,23		60	80 m/s	12200 rpm	10	321648																		
125 x 22,23		80	80 m/s	12200 rpm	10	321650																		

Please observe: Minimum order quantities for manufactured items see page 203. Please see Applications Guide on page 202-207.



# Abrasive mop discs

Abrasive mop disc

## SMT 325 EXTRA



<b>Class</b>	EXTRA
<b>Aggression</b>	■ ■ ■ ■ ■ □ □
<b>Service life</b>	■ ■ ■ ■ □ □ □

<b>Applications:</b>	
Stainless steel	●
Steel	●



<b>Properties</b>	
Grain	Zirconia alumina
Backing plate	Plastic, glass-fibre reinforced
Design	Convex 12°, flat

**Advantages:** Universal product for edges and surface work on steel and stainless steel - Good removal rate on angle grinders of all performance classes - No glazing, also under low grinding pressure

### Available grits:

16	24	30	36	40	50	60	80	100	120	150	180	220	240	280	320	360	400	500	600	800	1000	1200	1500	2000
Diameter x Bore in mm	Form	Grit	Max. operating speed	Max. RPM	Packing unit/pcs.	Cat. number																		
115 x 22,23		40	80 m/s	13300 rpm	10	321659																		
115 x 22,23		60	80 m/s	13300 rpm	10	321661																		
115 x 22,23		80	80 m/s	13300 rpm	10	321663																		
115 x 22,23		40	80 m/s	13300 rpm	10	321653																		
115 x 22,23		60	80 m/s	13300 rpm	10	321655																		
115 x 22,23		80	80 m/s	13300 rpm	10	321657																		
125 x 22,23		40	80 m/s	12200 rpm	10	321660																		
125 x 22,23		60	80 m/s	12200 rpm	10	321662																		
125 x 22,23		80	80 m/s	12200 rpm	10	321664																		
125 x 22,23		40	80 m/s	12200 rpm	10	321654																		
125 x 22,23		60	80 m/s	12200 rpm	10	321656																		
125 x 22,23		80	80 m/s	12200 rpm	10	321658																		

Please observe: Minimum order quantities for manufactured items see page 203. Please see Applications Guide on page 202-207.

Abrasive mop disc

## SMT 524 AC

ACCU



<b>Class</b>	ACCU
<b>Aggression</b>	■ ■ ■ ■ ■ □ □
<b>Service life</b>	■ ■ ■ ■ □ □ □

<b>Applications:</b>	
Stainless steel	●
Steel	●



**ACCU**

<b>Properties</b>	
Grain	Zirconia alumina
Backing plate	Glass fibre
Design	Convex 12°

**Advantages:** All-rounder for edge and face machining - Optimized removal rate with long service life for all battery-powered angle grinders

**Available grits:**

16	24	30	36	40	50	60	80	100	120	150	180	220	240	280	320	360	400	500	600	800	1000	1200	1500	2000
Diameter x Bore in mm	Form	Grit	Max. operating speed	Max. RPM	Packing unit/pcs.	Cat. number																		
115 x 22,23		40	80 m/s	13300 rpm	10	331172																		
115 x 22,23		60	80 m/s	13300 rpm	10	331173																		
115 x 22,23		80	80 m/s	13300 rpm	10	331174																		
125 x 22,23		40	80 m/s	12200 rpm	10	331175																		
125 x 22,23		60	80 m/s	12200 rpm	10	331176																		
125 x 22,23		80	80 m/s	12200 rpm	10	331177																		

Abrasive mop disc

## SMT 624

SUPRA



<b>Class</b>	SUPRA
<b>Aggression</b>	■ ■ ■ ■ ■ □ □
<b>Service life</b>	■ ■ ■ ■ □ □ □

<b>Applications:</b>	
Stainless steel	●
Steel	●



<b>Properties</b>	
Grain	Zirconia alumina
Backing plate	Glass fibre
Design	Convex 12°

**Advantages:** Aggressive stock removal rate and comfortable grinding behaviour - For universal use in demanding grinding work on steel and stainless steel - Optimal removal rate when used on high power angle grinders

**Available grits:**



















16	24	30	36	40	50	60	80	100	120	150	180	220	240	280	320	360	400	500	600	800	1000	1200	1500	2000
Diameter x Bore in mm	Form	Grit	Max. operating speed	Max. RPM	Packing unit/pcs.	Cat. number																		
100 x 16		36	80 m/s	15300 rpm	10	322758																		
100 x 16		40	80 m/s	15300 rpm	10	322759																		
100 x 16		60	80 m/s	15300 rpm	10	322760																		
100 x 16		80	80 m/s	15300 rpm	10	322761																		
100 x 16		120	80 m/s	15300 rpm	10	322762																		
115 x 22,23		36	80 m/s	13300 rpm	10	322764																		
115 x 22,23		40	80 m/s	13300 rpm	10	322765																		

**Continuation** →

Please observe: Minimum order quantities for manufactured items see page 203. Please see Applications Guide on page 202-207.

# Abrasive mop discs

→ Continuation of SMT 624, Abrasive mop disc

Diameter x Bore in mm	Form	Grit	Max. operating speed	Max. RPM	Packing unit/pcs.	Cat. number
115 x 22,23		50	80 m/s	13300 rpm	10	322766
115 x 22,23		60	80 m/s	13300 rpm	10	322767
115 x 22,23		80	80 m/s	13300 rpm	10	322768
115 x 22,23		120	80 m/s	13300 rpm	10	322769
125 x 22,23		36	80 m/s	12200 rpm	10	322771
125 x 22,23		40	80 m/s	12200 rpm	10	322772
125 x 22,23		50	80 m/s	12200 rpm	10	322773
125 x 22,23		60	80 m/s	12200 rpm	10	322774
125 x 22,23		80	80 m/s	12200 rpm	10	322775
125 x 22,23		120	80 m/s	12200 rpm	10	322776
150 x 22,23		40	80 m/s	10200 rpm	10	322778
150 x 22,23		60	80 m/s	10200 rpm	10	322779
150 x 22,23		80	80 m/s	10200 rpm	10	322780
180 x 22,23		36	80 m/s	8500 rpm	10	322782
180 x 22,23		40	80 m/s	8500 rpm	10	322783
180 x 22,23		60	80 m/s	8500 rpm	10	322785
180 x 22,23		80	80 m/s	8500 rpm	10	322786
180 x 22,23		120	80 m/s	8500 rpm	10	322787

Abrasive mop disc

## SMT 628 SUPRA



<b>Class</b>	SUPRA
Aggression	■■■■■■■□
Service life	■■■■■■■□

<b>Applications:</b>	
Stainless steel	●
Steel	●













<b>Properties</b>	
Grain	Zirconia alumina
Backing plate	Glass fibre
Design	Flat

**Advantages:** Especially suitable for surface grinding of steel and stainless steel - Optimal removal rate when used on high power angle grinders - Aggressive stock removal rate and comfortable grinding behaviour

Available grits:

16 24 30 36 40 50 60 80 100 120 150 180 220 240 280 320 360 400 500 600 800 1000 1200 1500 2000

Diameter x Bore in mm	Form	Grit	Max. operating speed	Max. RPM	Packing unit/pcs.	Cat. number
115 x 22,23		36	80 m/s	13300 rpm	10	322789
115 x 22,23		40	80 m/s	13300 rpm	10	322790
115 x 22,23		60	80 m/s	13300 rpm	10	322792
115 x 22,23		80	80 m/s	13300 rpm	10	322793
115 x 22,23		120	80 m/s	13300 rpm	10	322794
125 x 22,23		36	80 m/s	12200 rpm	10	322795
125 x 22,23		40	80 m/s	12200 rpm	10	322796
125 x 22,23		60	80 m/s	12200 rpm	10	322798
125 x 22,23		80	80 m/s	12200 rpm	10	322799
125 x 22,23		120	80 m/s	12200 rpm	10	322800

Continuation →

Please observe: Minimum order quantities for manufactured items see page 203. Please see Applications Guide on page 202-207.

# Abrasive mop discs



→ Continuation of SMT 628, Abrasive mop disc

Diameter x Bore in mm	Form	Grit	Max. operating speed	Max. RPM	Packing unit/pcs.	Cat. number
180 x 22,23		36	80 m/s	8500 rpm	10	322802
180 x 22,23		40	80 m/s	8500 rpm	10	322803
180 x 22,23		60	80 m/s	8500 rpm	10	322805
180 x 22,23		80	80 m/s	8500 rpm	10	322806

Abrasive mop disc

## SMT 626 SUPRA



Class	SUPRA
Aggression	■■■■■■■□
Service life	■■■■■■■□

Applications:	
Stainless steel	●
Steel	●



Properties	
Grain	Zirconia alumina
Backing plate	Glass fibre
Design	Convex 6°

**Advantages:** High material removal rates - Considerably longer service life due to unique flap angle

Available grits:

16	24	30	36	40	50	60	80	100	120	150	180	220	240	280	320	360	400	500	600	800	1000	1200	1500	2000
----	----	----	----	----	----	----	----	-----	-----	-----	-----	-----	-----	-----	-----	-----	-----	-----	-----	-----	------	------	------	------

Diameter x Bore in mm	Form	Grit	Max. operating speed	Max. RPM	Packing unit/pcs.	Cat. number
115 x 22,23		36	80 m/s	13300 rpm	10	321686
115 x 22,23		40	80 m/s	13300 rpm	10	321689
115 x 22,23		50	80 m/s	13300 rpm	10	321692
115 x 22,23		60	80 m/s	13300 rpm	10	321694
115 x 22,23		80	80 m/s	13300 rpm	10	321697
115 x 22,23		120	80 m/s	13300 rpm	10	321683
125 x 22,23		36	80 m/s	12200 rpm	10	321687
125 x 22,23		40	80 m/s	12200 rpm	10	321690
125 x 22,23		50	80 m/s	12200 rpm	10	321693
125 x 22,23		60	80 m/s	12200 rpm	10	321695
125 x 22,23		80	80 m/s	12200 rpm	10	321698
125 x 22,23		120	80 m/s	12200 rpm	10	321684
180 x 22,23		36	80 m/s	8500 rpm	10	321688
180 x 22,23		40	80 m/s	8500 rpm	10	321691
180 x 22,23		60	80 m/s	8500 rpm	10	321696
180 x 22,23		80	80 m/s	8500 rpm	10	321699

Please observe: Minimum order quantities for manufactured items see page 203. Please see Applications Guide on page 202-207.

# Abrasive mop discs

Abrasive mop disc, multibond

## SMT 636 SUPRA



<b>Class</b>	SUPRA
<b>Aggression</b>	■■■■■■■□
<b>Service life</b>	■■■■■■■□

<b>Applications:</b>	Stainless steel ●
----------------------	-------------------



<b>Properties</b>	
<b>Grain</b>	Zirconia alumina multibond
<b>Backing plate</b>	Glass fibre
<b>Design</b>	Convex 6°, flat

**Advantages:** Special product for use on stainless steel - Cool grinding due to multibond - Suitable for use on edges and surfaces - No glazing or clogging

### Available grits:

16	24	30	36	40	50	60	80	100	120	150	180	220	240	280	320	360	400	500	600	800	1000	1200	1500	2000
Diameter x Bore in mm	Form	Grit	Max. operating speed	Max. RPM	Packing unit/pcs.	Cat. number																		
115 x 22,23		40	80 m/s	13300 rpm	10	322826																		
115 x 22,23		60	80 m/s	13300 rpm	10	322827																		
115 x 22,23		80	80 m/s	13300 rpm	10	322828																		
125 x 22,23		40	80 m/s	12200 rpm	10	322831																		
125 x 22,23		60	80 m/s	12200 rpm	10	322832																		
125 x 22,23		80	80 m/s	12200 rpm	10	322833																		
180 x 22,23		40	80 m/s	8500 rpm	10	322836																		

Abrasive mop disc

## SMT 644 SUPRA



<b>Class</b>	SUPRA
<b>Aggression</b>	■■■■■■■□
<b>Service life</b>	■■■■■■■□

<b>Applications:</b>	Steel ● Stainless steel ●
----------------------	------------------------------



<b>Properties</b>	
<b>Grain</b>	Zirconia alumina
<b>Backing plate</b>	Glass fibre
<b>Design</b>	Convex 12°, flat

**Advantages:** Long service life when used on extremely steep edges - Constant stock removal level even when used on surfaces - No glazing or clogging, even at low machine output or low grinding pressure (<1000W)

### Available grits:

16	24	30	36	40	50	60	80	100	120	150	180	220	240	280	320	360	400	500	600	800	1000	1200	1500	2000
Diameter x Bore in mm	Form	Grit	Max. operating speed	Max. RPM	Packing unit/pcs.	Cat. number																		
115 x 22,23		40	80 m/s	13300 rpm	10	329993																		
115 x 22,23		60	80 m/s	13300 rpm	10	329994																		
115 x 22,23		80	80 m/s	13300 rpm	10	329995																		
115 x 22,23		120	80 m/s	13300 rpm	10	329996																		
115 x 22,23		40	80 m/s	13300 rpm	10	329989																		
115 x 22,23		60	80 m/s	13300 rpm	10	329990																		

Continuation →

Please observe: Minimum order quantities for manufactured items see page 203. Please see Applications Guide on page 202-207.



# Abrasive mop discs



→ Continuation of SMT 644, Abrasive mop disc

Diameter x Bore in mm	Form	Grit	Max. operating speed	Max. RPM	Packing unit/pcs.	Cat. number
115 x 22,23		80	80 m/s	13300 rpm	10	329991
125 x 22,23		40	80 m/s	12200 rpm	10	330005
125 x 22,23		60	80 m/s	12200 rpm	10	330006
125 x 22,23		80	80 m/s	12200 rpm	10	330007
125 x 22,23		120	80 m/s	12200 rpm	10	330008
125 x 22,23		40	80 m/s	12200 rpm	10	329997
125 x 22,23		60	80 m/s	12200 rpm	10	330002
125 x 22,23		80	80 m/s	12200 rpm	10	330003

Abrasive mop disc

## SMT 645 SUPRA



<b>Class</b>	SUPRA
<b>Aggression</b>	■■■■■■■□
<b>Service life</b>	■■■■■■■

<b>Applications:</b>	
Stainless steel	●
Steel	●



<b>Properties</b>	
Grain	Zirconia alumina
Backing plate	Plastic, glass-fibre reinforced
Design	Flat

**Advantages:** High edge stability - Very good removal rate also on low power angle grinders - Long service life due to double grinding flaps

### Available grits:

16 24 30 36 40 50 60 80 100 120 150 180 220 240 280 320 360 400 500 600 800 1000 1200 1500 2000

Diameter x Bore in mm	Form	Grit	Max. operating speed	Max. RPM	Packing unit/pcs.	Cat. number
115 x 22,23		40	80 m/s	13300 rpm	10	278590
115 x 22,23		60	80 m/s	13300 rpm	10	278591
115 x 22,23		80	80 m/s	13300 rpm	10	278592

Please observe: Minimum order quantities for manufactured items see page 203. Please see Applications Guide on page 202-207.



# Abrasive mop discs

Abrasive mop disc

## SMT 924 SPECIAL



<b>Class</b>	SPECIAL
<b>Aggression</b>	■■■■■■■■■
<b>Service life</b>	■■■■■■■■■

<b>Applications:</b>	
Stainless steel	●
Steel	●



<b>Properties</b>	
Grain	Ceramic Al. oxide
Backing plate	Glass fibre
Design	Convex 6°

**Advantages:** Highly aggressive abrasive performance for demanding work on edges - High edge stability - Optimal removal rate when used on high power angle grinders under increased grinding pressure

### Available grits:

16 24 30 36 40 50 60 80 100 120 150 180 220 240 280 320 360 400 500 600 800 1000 1200 1500 2000																			
Diameter x Bore in mm	Form	Grit	Max. operating speed	Max. RPM	Packing unit/pcs.	Cat. number													
115 x 22,23		40	80 m/s	13300 rpm	10	322862													
115 x 22,23		60	80 m/s	13300 rpm	10	322863													
115 x 22,23		80	80 m/s	13300 rpm	10	322864													
125 x 22,23		40	80 m/s	12200 rpm	10	322867													
125 x 22,23		60	80 m/s	12200 rpm	10	322868													
125 x 22,23		80	80 m/s	12200 rpm	10	322869													

Abrasive mop disc

## SMT 925 SPECIAL



<b>Class</b>	SPECIAL
<b>Aggression</b>	■■■■■■■■■
<b>Service life</b>	■■■■■■■■□

<b>Applications:</b>	
Stainless steel	●
Steel	●



<b>Properties</b>	
Grain	Zirconia alumina
Backing plate	Plastic, glass-fibre reinforced
Design	Convex 12°, flat

**Advantages:** Significantly higher abrasive performance and service life - Optimal removal rate when used on high-power angle grinders under increased grinding pressure - High removal rate and long service life

### Available grits:

16 24 30 36 40 50 60 80 100 120 150 180 220 240 280 320 360 400 500 600 800 1000 1200 1500 2000																			
Diameter x Bore in mm	Form	Grit	Max. operating speed	Max. RPM	Packing unit/pcs.	Cat. number													
115 x 22,23		40	80 m/s	13300 rpm	10	321714													
115 x 22,23		60	80 m/s	13300 rpm	10	321715													
115 x 22,23		36	80 m/s	13300 rpm	10	321668													
115 x 22,23		40	80 m/s	13300 rpm	10	321670													
115 x 22,23		60	80 m/s	13300 rpm	10	321674													
115 x 22,23		80	80 m/s	13300 rpm	10	321677													
125 x 22,23		36	80 m/s	12200 rpm	10	321718													

Continuation →

Please observe: Minimum order quantities for manufactured items see page 203. Please see Applications Guide on page 202-207.

# Abrasive mop discs



→ Continuation of SMT 925, Abrasive mop disc

Diameter x Bore in mm	Form	Grit	Max. operating speed	Max. RPM	Packing unit/pcs.	Cat. number
125 x 22,23		40	80 m/s	12200 rpm	10	321719
125 x 22,23		60	80 m/s	12200 rpm	10	321720
125 x 22,23		80	80 m/s	12200 rpm	10	321721
125 x 22,23		40	80 m/s	12200 rpm	10	321671
125 x 22,23		60	80 m/s	12200 rpm	10	321675
125 x 22,23		80	80 m/s	12200 rpm	10	321678
180 x 22,23		24	80 m/s	8500 rpm	5	321667
180 x 22,23		36	80 m/s	8500 rpm	5	321669
180 x 22,23		40	80 m/s	8500 rpm	5	321672
180 x 22,23		60	80 m/s	8500 rpm	5	321676

Abrasive mop disc

## SMT 926 SPECIAL



<b>Class</b>	SPECIAL
Aggression	■■■■■■■□
Service life	■■■■■■■

<b>Applications:</b>	
Stainless steel	●
Steel	●



<b>Properties</b>	
Grain	Zirconia alumina
Backing plate	Glass fibre
Design	Convex 6°

**Advantages:** Maximum removal rate and service life - Especially suitable for rough work on steel and stainless steel - Optimal removal rate when used on high power angle grinders under increased grinding pressure

Available grits:

16	24	30	36	40	50	60	80	100	120	150	180	220	240	280	320	360	400	500	600	800	1000	1200	1500	2000
----	----	----	----	----	----	----	----	-----	-----	-----	-----	-----	-----	-----	-----	-----	-----	-----	-----	-----	------	------	------	------

Diameter x Bore in mm	Form	Grit	Max. operating speed	Max. RPM	Packing unit/pcs.	Cat. number
115 x 22,23		40	80 m/s	13300 rpm	10	321703
115 x 22,23		60	80 m/s	13300 rpm	10	321706
115 x 22,23		80	80 m/s	13300 rpm	10	321708
125 x 22,23		40	80 m/s	12200 rpm	10	321704
125 x 22,23		60	80 m/s	12200 rpm	10	321707
125 x 22,23		80	80 m/s	12200 rpm	10	321709
180 x 22,23		40	80 m/s	8500 rpm	10	321705

Please observe: Minimum order quantities for manufactured items see page 203. Please see Applications Guide on page 202-207.

# Abrasive mop discs

Abrasive mop disc, multibond

## SMT 996 SPECIAL



<b>Class</b>	SPECIAL
<b>Aggression</b>	■■■■■■■■■
<b>Service life</b>	■■■■■■■□

<b>Applications:</b>	Stainless steel ●
----------------------	-------------------



<b>Properties</b>	
Grain	Ceramic aluminium oxide multibond
Backing plate	Glass fibre
Design	Convex 6°, flat

**Advantages:** Aggressive abrasive performance with little expenditure of energy - High edge stability - Cool grinding due to multibond - Optimal removal rate when used on high power angle grinders under increased grinding pressure

### Available grits:

16	24	30	36	40	50	60	80	100	120	150	180	220	240	280	320	360	400	500	600	800	1000	1200	1500	2000
Diameter x Bore in mm	Form	Grit	Max. operating speed	Max. RPM	Packing unit/pcs.	Cat. number																		
115 x 22,23		40	80 m/s	13300 rpm	10	322849																		
115 x 22,23		60	80 m/s	13300 rpm	10	322850																		
115 x 22,23		80	80 m/s	13300 rpm	10	322851																		
125 x 22,23		40	80 m/s	12200 rpm	10	322852																		
125 x 22,23		60	80 m/s	12200 rpm	10	322853																		
125 x 22,23		80	80 m/s	12200 rpm	10	322854																		

Abrasive mop disc, Corner grinder

## SMT 688 SPECIAL



<b>Class</b>	SPECIAL
<b>Aggression</b>	■■■■■■■□
<b>Service life</b>	■■■■■■□□

<b>Applications:</b>	Stainless steel ●
	Steel ●



<b>Properties</b>	
Grain	Zirconia alumina
Backing plate	Glass fibre
Design	Flat

**Advantages:** Special tool for use in difficult-to-access areas, such as grooves, slots and angles - Good adaptation of flaps to convex contours due to longer overlap

### Available grits:

16	24	30	36	40	50	60	80	100	120	150	180	220	240	280	320	360	400	500	600	800	1000	1200	1500	2000
----	----	----	----	----	----	----	----	-----	-----	-----	-----	-----	-----	-----	-----	-----	-----	-----	-----	-----	------	------	------	------

All sizes and minimum purchasing quantities available on request

Please observe: Minimum order quantities for manufactured items see page 203. Please see Applications Guide on page 202-207.

Non-woven mop disc

## SMT 800 SPECIAL









### Applications:

Stainless steel	●
Steel	●

### Properties

Backing plate	Glass fibre
Design	Convex 12°

**Advantages:** High quality non-woven mop disc for stainless steel finish work - Optimal results when used on variable speed angle grinders - Three grades

Diameter x Bore in mm	Form	Grade	Colour	Max. operating speed	Max. RPM	Recommended operating speed	Recommended RPM	Packing unit/pcs.	Cat. number
115 x 22,23		coarse	brown	80 m/s	13300 rpm	42 m/s	7000 rpm	5	278495
115 x 22,23		medium	maroon	80 m/s	13300 rpm	42 m/s	7000 rpm	5	278496
115 x 22,23		very fine	green	80 m/s	13300 rpm	42 m/s	7000 rpm	5	278497
125 x 22,23		coarse	brown	80 m/s	12200 rpm	42 m/s	6400 rpm	5	278498
125 x 22,23		medium	maroon	80 m/s	12200 rpm	42 m/s	6400 rpm	5	278499
125 x 22,23		very fine	green	80 m/s	12200 rpm	42 m/s	6400 rpm	5	278500

Combi-Abrasive mop disc

## SMT 850 plus SPECIAL









### Applications:

Stainless steel	●
-----------------	---

### Properties

Backing plate	Glass fibre
Design	Convex 12°

**Advantages:** High-quality combi non-woven mop disc - Specially suited for machining of WIG weld seams on stainless steel components - Even finish throughout the entire service life - Stock removal and finishing in one step

Diameter x Bore in mm	Form	Grit	Grade	Colour	Max. operating speed	Max. RPM	Recommended operating speed	Recommended RPM	Packing unit/pcs.	Cat. number
115 x 22,23		60	coarse	brown	80 m/s	13300 rpm	42 m/s	7000 rpm	5	312556
115 x 22,23		80	medium	maroon	80 m/s	13300 rpm	42 m/s	7000 rpm	5	312557
115 x 22,23		120	very fine	green	80 m/s	13300 rpm	42 m/s	7000 rpm	5	312558
125 x 22,23		60	coarse	brown	80 m/s	12200 rpm	42 m/s	6400 rpm	5	312559
125 x 22,23		80	medium	maroon	80 m/s	12200 rpm	42 m/s	6400 rpm	5	312560
125 x 22,23		120	very fine	green	80 m/s	12200 rpm	42 m/s	6400 rpm	5	312561

Please observe: Minimum order quantities for manufactured items see page 203. Please see Applications Guide on page 202-207.



# Non-woven web wheels

High performance non-woven web wheels

## MFW 600

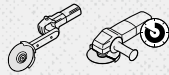

### Applications:

Steel	●
Stainless steel	●
NF metals	●

### Properties

Bonding agent	Resin
Grain	SiC

**Advantages:** Special product for finishing stainless steel weld seams - 4 different grades for material removal up to high gloss

Diameter x Width x Bore in mm	Grade	Colour	Max. operating speed	Max. RPM	Packing unit/pcs.	Cat. number
125 x 6 x 22	coarse	red	59 m/s	9000 rpm	5	342218
125 x 6 x 22	medium	grey	59 m/s	9000 rpm	5	342219
125 x 6 x 22	fine	grey	39 m/s	5900 rpm	5	342237
150 x 3 x 25,4	coarse	red	59 m/s	7500 rpm	10	337948
150 x 3 x 25,4	medium	grey	59 m/s	7500 rpm	10	337949
150 x 3 x 25,4	fine	grey	39 m/s	5000 rpm	10	337950
150 x 6 x 25,4	coarse	red	59 m/s	7500 rpm	5	337944
150 x 6 x 25,4	medium	grey	59 m/s	7500 rpm	5	337945
150 x 6 x 25,4	fine	grey	39 m/s	5000 rpm	5	337946
150 x 6 x 25,4	very fine	grey	39 m/s	5000 rpm	5	337947

High performance non-woven web wheels

## NUD 500



### Applications:

Alloyed steels	●
High alloy steel	●
Non-ferrous metals	●
Light metals	●
Chrome and nickel steels	●
Steel	●
Titanium	●

### Properties

Grain	SiC
-------	-----

**Advantages:** For cleaning and pre-polishing surfaces - For smoothing weld seams - Fewer work steps - Precise cleaning, clearing and finishing of surfaces - Achieves an ultra-low scratch depth on the processed material

Diameter x Width x Bore in mm	Grade	Colour	Max. operating speed	Max. RPM	Recommended RPM	Packing unit/pcs.	Cat. number
115 x 13 x 22,23	coarse	grey	63 m/s	10450 rpm	5800 rpm	5	337864
115 x 13 x 22,23	medium	grey	63 m/s	10450 rpm	5800 rpm	5	337865
115 x 13 x 22,23	very fine	grey	63 m/s	10450 rpm	5800 rpm	5	337866
125 x 13 x 22,23	coarse	grey	63 m/s	9600 rpm	5300 rpm	5	337861
125 x 13 x 22,23	medium	grey	63 m/s	9600 rpm	5300 rpm	5	337862
125 x 13 x 22,23	very fine	grey	63 m/s	9600 rpm	5300 rpm	5	337863

Please observe: Please see Applications Guide on page 203.

Cleaning wheel

## NCD 200





### Applications:

Metals	●
Paint/Varnish/Filler	●
Plastic	●
Stainless steel	⓪

### Properties

Bonding agent Resin	
Grain	SiC
Design	Flat

**Advantages:** Special SiC non-woven web for cleaning of surfaces and removal of heat tinting/blueing - No clogging due to open structure - For the removal of paint and rust

Diameter x Bore in mm	Form	Max. operating speed	Max. RPM	Packing unit/pcs.	Cat. number
115 x 22,23		63 m/s	10450 rpm	5	259043
125 x 22,23		63 m/s	9600 rpm	5	259044

Power wheel, extra coarse

## PW 2000

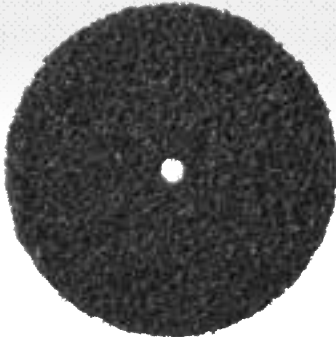
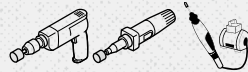

### Applications:

Paint/Varnish/Filler	●
Plastic	●
Metals	●
Stone	●

**Advantages:** Special non-woven web, ideal for removing heat tinting, oxide layers, rust and paint residue - For cleaning of weld seams - No clogging

Diameter x Width x Bore in mm	Max. operating speed	Max. RPM	Packing unit/pcs.	Cat. number
100 x 13 x 13	40 m/s	7600 rpm	10	194625
150 x 13 x 13	40 m/s	5000 rpm	10	194626
200 x 13 x 13	40 m/s	3800 rpm	10	241380

Please observe: Please see Applications Guide on page 203.



# Fixing spindle

Fixing spindle

## SD 2000



**Advantages:** For secure mounting on drilling machines, flexible shafts and stroke grinders and optimal true running of the grinding tool PW 2000

Shaft in mm	Suitable for	Packing unit/pcs.	Cat. number
6	1 wheel Ø 100 - Ø 200	1	194629
8	1-2 wheels Ø 100 - Ø 200	1	194632

# Notes



---

A large grid of small dots for taking notes, consisting of approximately 30 columns and 40 rows of dots.





# Kronenflex® cutting-off wheels and grinding discs

## About the product

As the inventor of the high speed cutting-off wheel, it is only natural that we strive to continually develop and improve our Kronenflex® products.

Kronenflex® cutting-off wheels and grinding discs feature an optimal combination of bonding agent and grain type for high aggressiveness, outstanding service life and consistently high quality. They comply with the highest safety standards, including the oSa regulations and the European safety standard EN 12413.

As a result of continuous innovations and the development of special products for diverse requirements, our Kronenflex® products offer the optimal solution for all standard materials and applications.

## Typical materials for these products

- ▶ Steel
- ▶ Stainless steel
- ▶ Construction steel
- ▶ NF metals
- ▶ Cast materials
- ▶ Stone
- ▶ Plastics
- ▶ Mineral materials
- ▶ Pipes
- ▶ Flat irons
- ▶ Tins
- ▶ Solid materials

## Typical applications for these products

- ▶ Bodywork
- ▶ Maintenance and repair work
- ▶ Locksmiths
- ▶ Steelwork
- ▶ Plant construction
- ▶ Container construction
- ▶ Upkeep
- ▶ Metal works
- ▶ Vehicle construction
- ▶ Foundries
- ▶ Shipyards

## Kronenflex® cutting-off wheels

Kronenflex® cutting-off wheels	Page
0,8–1,0 mm	234
Small cutting-off wheels	241
1,6–1,9 mm	242
2,0–3,2 mm	246
Large cutting-off wheels	254

## Kronenflex® grinding discs

Kronenflex® grinding discs	Page
Grinding discs	264

# Kronenflex® cutting-off wheels and grinding discs

Application guides

1. EAN code (EAN 13)
2. Safety pictograms
3. Max. operating speed
4. Klingspor cat. number
5. Specification of design, grade and bond according to EN 12413
6. Dimensions in mm and inches
7. Applications (see colour coding system)



8. Information about the manufacturer
9. Operating restrictions
10. Safety standard (oSa / EN 12413)
11. Max. RPM
12. Safety pictograms
13. Product group / type
14. Klingspor brand Kronenflex®

## Performance classes

Kronenflex® cutting-off wheels and grinding discs come in three performance classes with six colour codes for a quick overview of the most important material applications.



### EXTRA

Products for universal application, offering a particularly attractive price-performance ratio.



### SUPRA

Optimised products for different applications. Excellent service life and cutting performance.



### SPECIAL

High performance products for special applications. Highest service life and cutting performance in the respective material application area.



# Kronenflex® cutting-off wheels and grinding discs

Application guides



## 1. Label and cover sheet

The label includes all of the important information on the product, manufacturer and information on the proper use of the grinding tool

## 2. Mixture

**The grit:** Today all grit types are only produced synthetically. Only grit produced synthetically can ensure continuously high wear and cutting disc quality.

**Resins and fillers:** Additional, important components for cutting and grinding discs are resins, (in liquid and dry form), and fillers. These components are key in determining the disc properties, such as stability, stock removal rate, sheer strength and can be adjusted to meet the needs of the specific application.



## 3. Metal ring

Provides information on the expiry date of the disc.

## 4. Glass fibre

Glass fibre is a reinforcing layer to ensure stability and increases the safety of the cutting-off wheel. The number and strength of the glass fibre layers is dependent upon disc type and application.

The higher the potential lateral load on a cutting-off wheel (it is greater during free cutting than during stationary cutting), the more glass fibre that the cutting disc must contain, or the contained glass fibre must be more stable. Particularly thin material is used for thin cutting discs, (0.8 mm to 1.0 mm), to ensure that a large grit ratio is achieved between the layers. Grinding discs are constructed with at least 3 glass fibre layers.

## Klingspor cutting-off wheel and grinding disc colour coding system



**Metal universal:**  
Grey



**Stainless steel:**  
Blue



**Aluminium:**  
Silver



**Steel:**  
Black



**Castings:**  
Red



**Stone/concrete:**  
Green



# Kronenflex® cutting-off wheels and grinding discs

## Application guides



Quarter	
V 01	January-March
V 04	April-June
V 07	July-September
V 10	October-December

## Safety and storage

The shelf life of cutting-off wheels and grinding discs is primarily determined by their moisture content. Cutting-off wheels and grinding discs that are subjected to increased humidity after they were manufactured lose their original service life. Correct storage ensures a consistent long service life. Cutting-off wheels and grinding discs that are subjected to water or steam are a safety risk. The user is obligated to use the product correctly. Cutting-off wheels and grinding discs should not be used past the expiry date.

## Working safely

### By being careful and recognising risks

Please avoid the risks listed below when working with cutting-off wheels and grinding discs.

- ▶ contact with rotating abrasive discs
- ▶ abrasive disc breakage
- ▶ grinding dust and debris
- ▶ vibration
- ▶ noise

### Through personal protective gear

Goggles, gloves, ear muffs and dust masks must be worn. When working on hard grinding applications additional protective gear is required, such as face protection, leather aprons and safety boots.

### With protective machine guards

Machine guards are supplied with the grinding machine and may not be changed or removed. When using cup grinding wheels the outer surface must be completely enclosed.

In addition, cup grinding wheels may only be used in combination with an adjustable wheel guard, to balance the wear on the disc and to keep the exposure of the disc at a minimum.

### Through visual inspection and performance of checks prior to mounting

Ensure the disc RPM matches the machine RPM setting and avoid exceeding the maximum admissible operating speed. Carefully check the cutting-off wheel and grinding disc for damage. If the cutting-off wheel or grinding disc is damaged, do not use the damaged product. Our cutting-off wheels and grinding discs are marked with the corresponding safety pictograms.

### Through correct use

Ensure that the respective disc is being used correctly. Avoid damage to the mounting bore or to the disc through jerks, excessive force, or falls. Ensure that the disc is correctly and securely mounted and use the correct mounting flange. Prior to starting work, the abrasive disc should run at operating speed for at least 30 seconds. Please observe the FEPA safety regulations and the European Standard 12413.

The peripheral speed and grinding pressure are important parameters for achieving optimal cutting-off and grinding disc results.



## The optimal speed

### Too low

If the RPM of the machine is too low, the cutting-off wheel and grinding disc tend to “jump”, and the disc edges wear down unevenly. Particularly with thin material cross sections, such as cutting tin or wire, this causes the grit to be separated from the bond and the disc wear speed is above average.

### Optimal

Klingspor cutting-off wheels and grinding discs are high performance products and were developed such that best disc performance (measured according the stock removal volume to disc wear ratio) is achieved in the range right below the maximum peripheral speed. Keep the machine running at a consistently high RPM and, if needed, select a more powerful machine.

### Too high

The maximum RPM and peripheral speed is printed on the label of each disc. For your own safety, please be sure not to exceed the recommended speeds when grinding.

## The correct grinding pressure

An important requirement for a satisfactory cutting result is the correct grinding pressure. A common mistake is to reduce the grinding pressure to preserve the disc and extend the cutting life of the wheel. If this is done, the material overheats (turns blue); the cutting-off wheel becomes clogged and “burns up”. This is why the grinding pressure should always be set such that the cutting time is as short as possible. This is particularly true for heat sensitive material with large material cross sections.

## The proper hardness

### Cutting-off wheels

Generally, the rule of thumb when selecting the correct cutting-off wheel is: the harder the material, the softer the abrasive bond. The reason: the service life of a cutting-off wheel is dependent on whether the cutting surface of the workpiece hardens or not. Overheating results in the disc “glazing” and the cutting properties are negatively affected. In this case, the hardness of the bond should be decreased and a softer cutting-off wheel should be used.

### Grinding discs

The rule of thumb also applies to grinding discs: the harder the material, the softer the grinding disc bond. In addition, the application plays a decisive role. Corner grinding and the grinding of burrs and sharp edges can cause grit to be removed from the bond. We suggest the selection of a hard bond. On the other hand, when working on surfaces or small weld seams a disc that is too hard would become dull and would no longer be effective. It would have a good service life, but would also have a low stock removal rate and high work costs. A medium or soft disc bond would be best for finish grinding.

# Kronenflex® cutting-off wheels and grinding discs

## Application guides

### Correct application/techniques for cutting-off

Pressure may only be placed on the cutting-off wheel from a radial direction. This is the only way to avoid wobbling, buckling and disc breakage, especially when applying a high level of cutting pressure. The workpiece that is to be cut-off should be properly affixed to the workbench to ensure that the disc does not slide off to the side. In addition, we recommend that the material is affixed as close to the cutting site as possible to ensure that it does not vibrate, flutter or slip to the side.

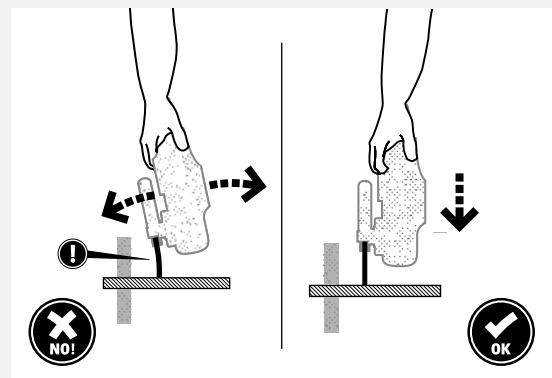
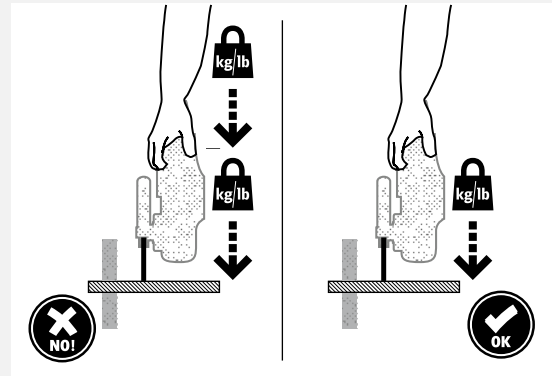

### Correct application/techniques for grinding

Grinding discs work best at 35 degree angle to the workpiece. This angle provides the best stock removal to disc wear ratio. If possible, always select this angle. When grinding and the angle is below 15° a very thin edge which levels off is formed around the circumference of the disc. Even minimal changes to the angle can result in a situation in which the grinding pressure can no longer be absorbed resulting in the grinding disc slipping to the side. Valuable grit is not used and an imbalance is created that results in having to replace the disc prematurely.

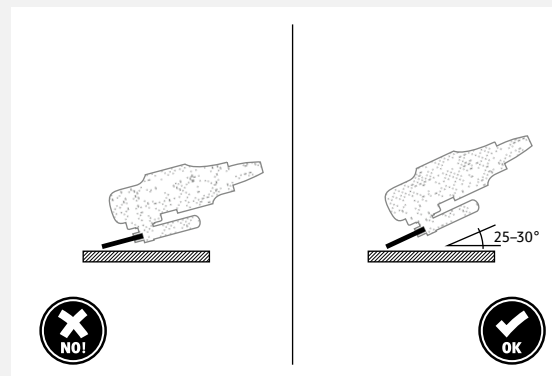
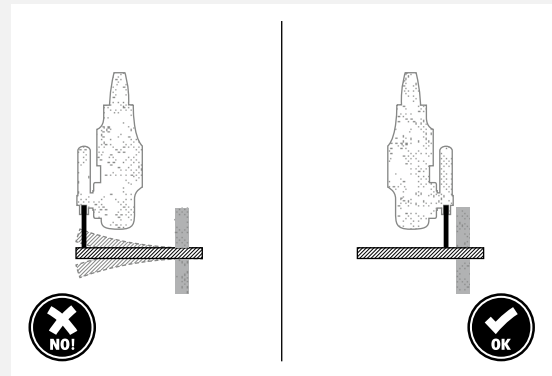

## The correct mount

### For better power transmission

Cutting-off wheels and grinding discs are mounted to the machine with side flanges. The flange elements are responsible for transferring power to the disc. For reasons of safety it is extremely important that defective or incorrect flanges are not used.

### For more safety

The use of wheel flange FL 76 provides increased lateral stability and user control, specifically when using thin cutting-off wheels with a flat form and diameter of 180 mm and 230 mm.

The applicable regulations and standards must be complied with when using the wheel flange. The contact surface and diameter of the wheel flange must match. Using wheel flanges with diameters that do not match is prohibited.

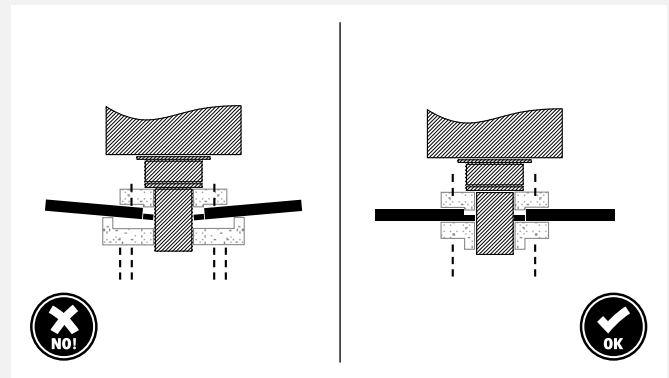

## Depressed centre grinding discs

4 - 10 mm thickness

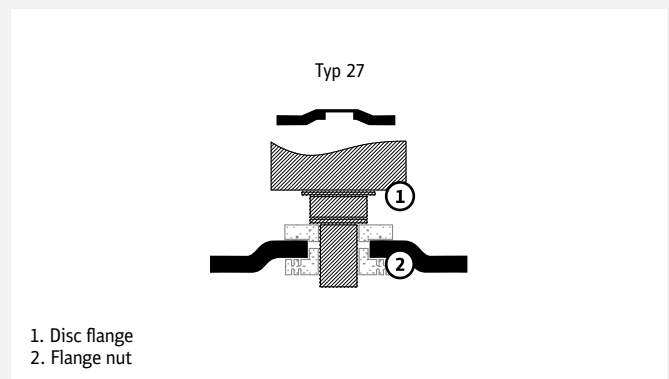

## Flat and depressed centre cutting-off wheels

0.8 - 4 mm thickness

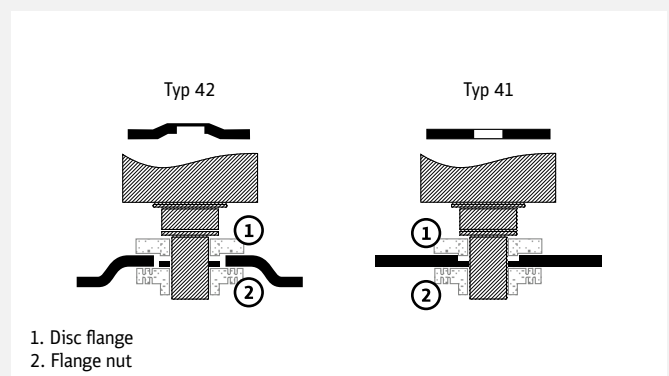

# Kronenflex® cutting-off wheels and grinding discs

## Application guides

### Recognise and avoid errors

	Issue	Possible cause	Solution
Cutting-off wheels	Cutting surface is blue	Cutting time is too long	Increase feed speed or grinding pressure
		Drive power is too low	Use a more powerful machine
		Disc is too hard	Select a softer bond
		Material cross section is too great for the disc diameter	Work with a saw cut / work with a smaller material diameter
		Cutting disc is too wide for the material/application	Use a thinner cutting disc
	Disc wear is too high	White cutting surface: disc hardness is too low	Select a harder bond
		Peripheral speed is too low	Increase peripheral speed
		RPM decrease is too great	Reduce grinding pressure or use a more powerful machine
	Crooked cut	Workpiece is not mounted properly	Mount the material closer to the cutting site
		Grinding pressure is too great	Reduce grinding pressure
		Disc width is too thin for the material/application	Increase disc width
		Disc is completely worn down	Replace disc
	Disc breakage	Machine is operated incorrectly	Avoid lateral pressure on the disc
		Incorrect wheel flange diameter	Use wheel flange with identical diameters
	Disc periphery is frayed	Cutting-off wheel is used for grinding	Cutting-off wheels may not be used for grinding
Material is not properly affixed		Mount the material closer to the cutting site	
Disc periphery is burned		Select a softer bond, decrease grinding pressure	
Disc jumps	Material is not properly affixed	Mount the material closer to the cutting site	
	Wheel flange is dirty or worn out	Clean wheel flange or replace wheel flange	
	Bearing is defective	Replace machine or replace bearing	
Bore hole is broken	Bore dimension and mount do not match	Use proper bore dimension or use a reducer ring	
	Wheel flanges are of different sizes	Use wheel flanges that have the same diameters	
	Machine is operated incorrectly	Reduce lateral pressure on the disc	
	Cutting-off wheel is used for grinding	Cutting-off wheels may not be used for grinding	

	Issue	Possible cause	Solution
Grinding discs	Removal rate is too low	Shiny contact surface: bond is too hard	Select a softer bond
		Grinding pressure is too low	Increase grinding pressure
		Machine performance is too low	Use a more powerful machine
	Disc is loaded/clogged	Bond is too hard	Select a softer bond
		Loading/clogging with NF metals	Use softer bond or select a special cutting-off wheel for NF metals
	Wear is too high	Grinding pressure is too low	Increase grinding pressure
		Grinding pressure is too high	Reduce grinding pressure
		Bond is too soft	Select a harder bond
		Machine RPM decreases too quickly	Reduce grinding pressure
		Machine performance is too low	Use a more powerful machine
	Periphery is not rounded / breakage on the edge	Disc angle is too flat	Increase disc angle (at least 25°)
		Grinding pressure is too high	Reduce grinding pressure
	Disc wobbles	The mount is not centred	Check bore diameter and mounting diameter and adjust accordingly
		Mounting shaft is worn	Replace machine
		Mounting flange is worn / dirty / incorrect	Replace / clean mounting flange / check dimensions
Disc wobbles		Use a new disc	

## What the type designation reveals about the design of cutting-off wheels and grinding discs

The type designation given on a cutting-off wheel or grinding disc divulges more than just the name of the product. It provides important information on the performance class and on the composition of the tool. The first letter indicates which abrasive grit is used. If this letter is followed by a three digit number, the first digit signifies the performance class (the performance class is also included below the name of the product). The last two digits point to the size of the grit that was used. The letters at the end of the type designation mark the hardness grade of a cutting-off wheel or grinding disc.

Grit type	Performance class	Grit size according to FEPA standard	Hardness	Performance class
<b>A</b> Aluminium oxide	<b>3</b> <b>EXTRA</b>	<b>16</b>	<b>M</b> soft	<b>EXTRA</b>
<b>C</b> Silicon carbide	<b>6</b> <b>SUPRA</b>	<b>24</b>	<b>N</b>	<b>SUPRA</b>
<b>Z</b> Zirconia alumina	<b>9</b> <b>SPECIAL</b>	<b>30</b>	<b>R</b>	<b>SPECIAL</b>
		<b>36</b>	<b>S</b>	
		<b>46</b>	<b>T</b> hard	
		<b>60</b>		
		<b>80</b>		

Explained by example of the Z 960 TX cutting-off wheel

Grit type	Performance class	Grit size according to FEPA standard	Hardness	Performance class
<b>Z</b> Zirconia alumina	<b>9</b> <b>SPECIAL</b>	<b>60</b>	<b>TX</b> hard	<b>SPECIAL</b>

## The safe use of Klingspor abrasives

Klingspor Kronenflex cutting-off wheels and grinding discs are manufactured in accordance with the oSa and EN12413 standards, this ensures the highest level of user safety.



Wear safety goggles or glasses to protect the eyes



Wear safety gloves to protect hands



Wear dust mask



Observe safety instructions



Use ear muffs



Do not use for wet grinding



Not permitted for face grinding



Do not use if damaged



# Kronenflex® cutting-off wheels

## 0,8 – 1,0 mm

### About the product

Klingspor Kronenflex® cutting-off wheels with a disc thickness of 0,8 to 1,0 mm are very thin cutting-off wheels with very short cutting times and minimal burr formation.

These cutting-off wheels develop their full power when working on thin-walled materials and are known for their precise, accurate and fast cuts at lowest thermal loads. Due to the cutting-off wheels' excellent cutting properties the weight of the machine itself provides suitable grinding pressure.

Klingspor Kronenflex® cutting-off wheels of the 0,8 to 1,0 mm class are known for their high level of safety, efficiency and productivity.

### Typical materials for these products

- ▶ Steel
- ▶ Stainless steel
- ▶ Cast materials
- ▶ Construction steel
- ▶ NF metals
- ▶ Thin-walled profiles
- ▶ Thin tins
- ▶ Thin pipes
- ▶ Corrugated sheeting
- ▶ Flat irons
- ▶ Cable ducts
- ▶ Steel cables

### Typical applications for these products

- ▶ Bodywork
- ▶ Maintenance and repair work
- ▶ Locksmiths
- ▶ Steelwork
- ▶ Plant construction
- ▶ Container construction
- ▶ Upkeep
- ▶ Metal works
- ▶ Vehicle construction

Material applications

Type	Thickness [mm]	Steel	Hardened steel	Tool steel	Stainless steel	High alloy steel	Corrosion and acid proof steels	Aluminium	Bronze	Copper	Brass	Zinc die-casting	Cast iron	Page
A 60 EXTRA	1,0	●	○	○	●	○	○	○	○	○	○	○	○	236, 237
A 660 R SUPRA	1,0	●	●	●	●	○	○	○	○	○	○	○	○	238
A 60 TZ SPECIAL INOX	1,0	●	●	●	●	●	●	○	○	○	○	●	○	238, 239
A 560 AC ACCU	1,0	●	●	●	●	●	●	○	○	○	○	●	○	235
A 960 TZ SPECIAL	1,0	●	●	●	●	●	●	○	○	○	○	●	○	239
A 980 TZ SPECIAL	0,8	●	●	●	●	●	●	●	○	○	○	○	○	235
A 60 N SUPRA	1,0	○	○	○	○	○	○	●	●	●	●	○	○	237
K 960 TX SPECIAL	1,0	●	●	●	●	●	●	○	○	○	○	●	●	240
Z 960 TX SPECIAL	1,0	●	●	●	●	●	●	○	○	○	○	●	○	240
A 660 R SUPRA Small cutting-off wheel	1,0-1,6	●	●	●	○	○	○	○	○	○	○	○	○	241

● = main application ○ = possible applications

#### Kronenflex® Tub

Due to climatic influences in the first weeks after production, cutting discs usually lose significant performance. In order for you to be able to appreciate all benefits of our newly developed product, it comes in the airtight Kronenflex® tub.

In comparison with carton packaging the discs stay fresh much longer and gain up to 40% more performance.



# Kronenflex® cutting-off wheels 0,8 - 1,0 mm for hand held machines



Cutting-off wheels

Cutting-off wheel INOX

## A 980 TZ SPECIAL



Class	SPECIAL	Applications:
Bond	■ ■ ■ ■ ■ ■ ■ □	Stainless steel ●
Aggression	■ ■ ■ ■ ■ □ □	Steel ●
Service life	■ ■ ■ ■ ■ □	NF metals ●

**Advantages:** Free of iron, sulfur and chlorine - Very short cutting times - Very precise and clean cuts - Low thermal load - Minimal burr formation, minimizing finish-machining - 25 pieces delivered in the Kronenflex® box for long-lasting high performance and moisture protection

Diameter x Width x Bore in mm	Form	Max. operating speed	Max. RPM	Packing unit/pcs.	Cat. number
115 x 0,8 x 22,23		80 m/s	13300 rpm	25	322182
125 x 0,8 x 22,23		80 m/s	12200 rpm	25	322183

Cutting-off wheel

## A 560 AC ACCU



**ACCU**

Class	ACCU	Applications:
Bond	■ ■ ■ ■ ■ □ □	Stainless steel ●
Aggression	■ ■ ■ ■ ■ □ □	Steel ●
Service life	■ ■ ■ ■ ■ □	NF metals ●

**Advantages:** Free of iron, sulfur and chlorine - Optimized cutting performance through short cutting times and low thermal load - For all battery-powered angle grinders

Diameter x Width x Bore in mm	Form	Max. operating speed	Max. RPM	Packing unit/pcs.	Cat. number
115 x 1 x 22,23		80 m/s	13300 rpm	25	331167
125 x 1 x 22,23		80 m/s	12200 rpm	25	331168

Please observe: Please see Applications Guide on page 224-233, 234.

# Kronenflex® cutting-off wheels 0,8 - 1,0 mm

for hand held machines

Cutting-off wheel

## A 60 EXTRA



<b>Class</b>	EXTRA
Bond	■ ■ ■ ■ ■ □ □
Aggression	■ ■ ■ ■ □ □ □
Service life	■ ■ ■ ■ ■ □ □

<b>Applications:</b>	
Stainless steel	●
Metals	●

**Advantages:** Minimal burr formation - Low thermal load - Very good price-performance ratio

Diameter x Width x Bore in mm	Form	Max. operating speed	Max. RPM	Packing unit/pcs.	Cat. number
115 x 1 x 22,23	—	80 m/s	13300 rpm	25	262936
125 x 1 x 22,23	—	80 m/s	12200 rpm	25	262937

Cutting-off wheel

## A 60 EXTRA



<b>Class</b>	EXTRA
Bond	■ ■ ■ ■ ■ □ □
Aggression	■ ■ ■ ■ □ □ □
Service life	■ ■ ■ ■ ■ □ □

<b>Applications:</b>	
Stainless steel	●
Metals	●

**Advantages:** Minimal burr formation - Low thermal load - Very good price-performance ratio - 10 pieces in a tin with viewing window

Diameter x Width x Bore in mm	Form	Max. operating speed	Max. RPM	Packing unit/tin	Cat. number
125 x 1 x 22,23	—	80 m/s	12200 rpm	10 discs	310500

Minimum order quantity = 5 tins

Please observe: Please see Applications Guide on page 224-233, 234.

# Kronenflex® cutting-off wheels 0,8 - 1,0 mm for hand held machines



Cutting-off wheel

## A 60 EXTRA



<b>Class</b>	EXTRA	<b>Applications:</b>
Bond	■ ■ ■ ■ ■ □ □	Stainless steel ●
Aggression	■ ■ ■ ■ □ □ □	Metals ●
Service life	■ ■ ■ ■ ■ □ □	

**Advantages:** Minimal burr formation - Low thermal load - Very good price-performance ratio - 5 tins in a sales display

Diameter x Width x Bore in mm	Form	Max. operating speed	Max. RPM	Packing unit/display	Cat. number
125 x 1 x 22,23	—	80 m/s	12200 rpm	5 tins with 10 discs	312031

Cutting-off wheel

## A 60 N SUPRA



<b>Class</b>	SUPRA	<b>Applications:</b>
Bond	■ ■ ■ □ □ □ □	Aluminium ●
Aggression	■ ■ ■ ■ ■ □ □	Steel ①
Service life	■ ■ ■ ■ ■ □ □	

**Advantages:** Special combination prevents smearing and clogging - Minimal burr formation

Diameter x Width x Bore in mm	Form	Max. operating speed	Max. RPM	Packing unit/pcs.	Cat. number
115 x 1 x 22,23	—	80 m/s	13300 rpm	25	264297
125 x 1 x 22,23	—	80 m/s	12200 rpm	25	264298

Please observe: Please see Applications Guide on page 224-233, 234.

# Kronenflex® cutting-off wheels 0,8 - 1,0 mm for hand held machines

Cutting-off wheel INOX

## A 660 R SUPRA



Fe-S-Cl  
<0,1%

<b>Class</b>	SUPRA
<b>Bond</b>	■ ■ ■ ■ ■ □ □
<b>Aggression</b>	■ ■ ■ ■ ■ □ □
<b>Service life</b>	■ ■ ■ ■ ■ □ □

<b>Applications:</b>	
Stainless steel	●
Steel	●

**Advantages:** Minimal burr formation - Low thermal load - Highest cutting performance

Diameter x Width x Bore in mm	Form	Max. operating speed	Max. RPM	Packing unit/pcs.	Cat. number
115 x 1 x 22,23	—	80 m/s	13300 rpm	25	328905
125 x 1 x 22,23	—	80 m/s	12200 rpm	25	328906

Cutting-off wheel

## A 60 TZ SPECIAL



Fe-S-Cl  
<0,1%

<b>Class</b>	SPECIAL
<b>Bond</b>	■ ■ ■ ■ ■ □ □
<b>Aggression</b>	■ ■ ■ ■ ■ □ □
<b>Service life</b>	■ ■ ■ ■ ■ □ □

<b>Applications:</b>	
Stainless steel	●
Steel	●
NF metals	○

**Advantages:** Free of iron, sulfur and chlorine - Short cutting times - Minimal burr formation - Low thermal load

Diameter x Width x Bore in mm	Form	Max. operating speed	Max. RPM	Packing unit/pcs.	Cat. number
100 x 1 x 16	—	80 m/s	15300 rpm	25	202402
115 x 1 x 22,23	—	80 m/s	13300 rpm	25	202400
115 x 1 x 22,23	—	80 m/s	13300 rpm	25	233741
125 x 1 x 22,23	—	80 m/s	12200 rpm	25	202401
125 x 1 x 22,23	—	80 m/s	12200 rpm	25	233742

Please observe: Please see Applications Guide on page 224-233, 234.



# Kronenflex® cutting-off wheels 0,8 - 1,0 mm for hand held machines



Cutting-off wheels

Cutting-off wheel

## A 60 TZ SPECIAL



Class	SPECIAL	Applications:
Bond	■ ■ ■ ■ ■ ■ ■ ■ □	Stainless steel ●
Aggression	■ ■ ■ ■ ■ ■ ■ □	Steel ●
Service life	■ ■ ■ ■ ■ ■ ■ □	NF metals ○

**Advantages:** Free of iron, sulphur and chlorine - Fast cutting - Minimal burr formation - Low thermal load - 10 pieces in a tin with viewing window

Diameter x Width x Bore in mm	Form	Max. operating speed	Max. RPM	Packing unit/tin	Cat. number
115 x 1 x 22,23	—	80 m/s	13300 rpm	10 discs	310503
125 x 1 x 22,23	—	80 m/s	12200 rpm	10 discs	310504

Minimum order quantity = 5 tins

Cutting-off wheel INOX

## A 960 TZ SPECIAL



Class	SPECIAL	Applications:
Bond	■ ■ ■ ■ ■ ■ ■ ■ ■	Stainless steel ●
Aggression	■ ■ ■ ■ ■ ■ ■ □	Steel ●
Service life	■ ■ ■ ■ ■ ■ ■ ■ ■	

**Advantages:** Free of iron, sulphur and chlorine - Short cutting times and long service life - Low thermal load - Low burr formation - Optimized bonding for considerably longer service life - For diverse applications - 25 pieces delivered in the Kronenflex® box for long lasting high performance and moisture protection

Diameter x Width x Bore in mm	Form	Max. operating speed	Max. RPM	Packing unit/pcs.	Cat. number
115 x 1 x 22,23	—	80 m/s	13300 rpm	25	322180
125 x 1 x 22,23	—	80 m/s	12200 rpm	25	322181

Please observe: Please see Applications Guide on page 224-233, 234.



# Kronenflex® cutting-off wheels 0,8 - 1,0 mm

for hand held machines

Ceramic cutting-off wheel

## K 960 TX SPECIAL

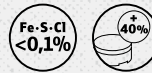

### CERAMIC

<b>Class</b>	SPECIAL
<b>Bond</b>	■■■■■■■■■
<b>Aggression</b>	■■■■■■■■■
<b>Service life</b>	■■■■■■■■■

<b>Applications:</b>	
Steel	●
Stainless steel	●
High alloy steel	●
Carbon steel	●
Titanium	●

**Advantages:** Free of iron, sulfur and chlorine - Outstanding performance in daily use - Highest cutting performance, even with low grinding pressure - 25 pieces delivered in the Kronenflex® box for long lasting high performance and moisture protection

Diameter x Width x Bore in mm	Form	Max. operating speed	Max. RPM	Packing unit/pcs.	Cat. number
115 x 1 x 22,23	— —	80 m/s	13300 rpm	25	328885
125 x 1 x 22,23	— —	80 m/s	12200 rpm	25	328886

Cutting-off wheel INOX

## Z 960 TX SPECIAL

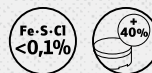

### ZIRCONIUM

<b>Class</b>	SPECIAL
<b>Bond</b>	■■■■■■■■■
<b>Aggression</b>	■■■■■■■■■
<b>Service life</b>	■■■■■■■■■

<b>Applications:</b>	
Stainless steel	●
Alloys	●
Carbon steel	●
Titanium	●

**Advantages:** Free of iron, sulphur and chlorine - Ideal for tough/hard materials such as titanium and high alloy steels - Short cutting times and long service life due to self-sharpening zirconia alumina - Low thermal load - Low burr formation - 25 pieces delivered in the Kronenflex® box for long lasting high performance and moisture protection

Diameter x Width x Bore in mm	Form	Max. operating speed	Max. RPM	Packing unit/pcs.	Cat. number
115 x 1 x 22,23	— —	80 m/s	13300 rpm	25	322184
125 x 1 x 22,23	— —	80 m/s	12200 rpm	25	322185

Please observe: Please see Applications Guide on page 224-233, 234.

# Kronenflex® small cutting-off wheels for hand held machines



Small cutting-off wheel

## A 660 R SUPRA

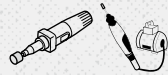

<b>Class</b>	SUPRA		<b>Applications:</b>
Bond	■ ■ ■ ■ ■ ■ □ □	Steel	●
Aggression	■ ■ ■ ■ ■ ■ □ □	Stainless steel	●
Service life	■ ■ ■ ■ ■ □ □ □		

**Advantages:** Minimal burr formation - For universal use in hard-to-reach areas - For cutting tins, profiles and solid materials

Diameter x Width x Bore in mm	Form	Max. operating speed	Max. RPM	Packing unit/pcs.	Cat. number
50 x 1 x 6	—	100 m/s	38200 rpm	100	329096
50 x 1 x 10	—	100 m/s	38200 rpm	100	329097
76 x 1 x 6	—	100 m/s	25200 rpm	100	329098
76 x 1 x 10	—	100 m/s	25200 rpm	100	329099
76 x 1,6 x 6	—	100 m/s	25200 rpm	100	329100
76 x 1,6 x 10	—	100 m/s	25200 rpm	100	329101
100 x 1 x 6	—	100 m/s	19000 rpm	25	329102
100 x 1 x 10	—	100 m/s	19000 rpm	25	329103

Fixing spindle

## SD 660



**Advantages:** Fixing spindle for clamping on the small A 660 R cutting blades onto straight grinders, flexible shafts, and drilling machines - Fits 6 and 10 mm holes

Size in mm	Suitable for	Packing unit/pcs.	Cat. number
6	6 and 10 mm bore	1	337156

Please observe: Please see Applications Guide on page 224-233, 234.

# Kronenflex® cutting-off wheels

## 1,6 – 1,9 mm

### About the product

Klingspor Kronenflex® cutting-off wheels with a disc thickness of 1,6 to 1,9 mm combine excellent cutting properties with a high degree of lateral stability.

These wheels provide convincing arguments especially in day-to-day applications when working on materials with medium-strength cross sections. They are known for their short cutting time, good stability and minimal burr formation.

These advantages in connection with the wide range of applications make Klingspor Kronenflex cutting wheels of the 1,6 to 1,9 mm class the highest performing universal wheel for daily use in metalworking.

### Typical materials for these products

- ▶ Steel
- ▶ Stainless steel
- ▶ Construction steel
- ▶ NF metals
- ▶ Cast materials
- ▶ Pipes
- ▶ Flat iron
- ▶ Tins
- ▶ Solid materials

### Typical applications for these products

- ▶ Locksmiths
- ▶ Shipyards
- ▶ Steelwork
- ▶ Plant construction
- ▶ Metal works
- ▶ Vehicle construction

Material applications														
Type	Thickness [mm]	Steel	Hardened Steel	Tool steel	Stainless steel	High alloy steels	Corrosion and acid proof steels	Aluminium	Bronze	Copper	Brass	Die-cast aluminium	Zinc die-casting	Page
A 346 EXTRA	1,6-1,9	●	○	○	●	○	●		○	○	○	○	○	243
A 646 R SUPRA	1,6-1,9	●	●	○	●	●	●							243
A 46 TZ SPECIAL INOX	1,6-1,9	●	●	●	●	●	●	○	○	○	○		●	244
A 946 TZ SPECIAL	1,6-1,9	●	●	●	●	●	●		○	○	○	○	○	244

● = main application ○ = possible applications

# Kronenflex® cutting-off wheels 1,6 - 1,9 mm for hand held machines



Cutting-off wheels

Cutting-off wheel

## A 346 EXTRA



Fe-S-Cl  
<0,1%

**NEW**

Class	EXTRA	Applications:
Bond	■ ■ ■ ■ ■ □ □ □	Aluminium ●
Aggression	■ ■ ■ ■ ■ □ □ □	Stainless steel ●
Service life	■ ■ ■ ■ ■ □ □ □	Steel ●

**Advantages:** Free of iron, sulphur and chlorine - Universal use on steel and stainless steel (INOX) - Cutting disc made of a calcined, cubic aluminium oxide that is self-sharpening - Minimal burr formation and longer service life - Best suited for cutting thin-walled profiles and pipes

Diameter x Width x Bore in mm	Form	Max. operating speed	Max. RPM	Packing unit/pcs.	Cat. number
115 x 1,6 x 22,23	—	80 m/s	13300 rpm	25	340936
125 x 1,6 x 22,23	—	80 m/s	12200 rpm	25	340938

Cutting-off wheel INOX

## A 646 R SUPRA



Fe-S-Cl  
<0,1%

**NEW**

Class	SUPRA	Applications:
Bond	■ ■ ■ ■ ■ ■ □ □	Stainless steel ●
Aggression	■ ■ ■ ■ ■ ■ □ □	Steel ●
Service life	■ ■ ■ ■ ■ □ □ □	

**Advantages:** Free of iron, sulphur and chlorine - Universal use on steel and stainless steel (INOX) - Cutting disk made of self-sharpening, calcined aluminum oxide - Tremendous aggressiveness when used for cutting solid steel materials

Diameter x Width x Bore in mm	Form	Max. operating speed	Max. RPM	Packing unit/pcs.	Cat. number
115 x 1,6 x 22,23	—	80 m/s	13300 rpm	25	340947
125 x 1,6 x 22,23	—	80 m/s	12200 rpm	25	340946
150 x 1,6 x 22,23	—	80 m/s	10200 rpm	25	340945
180 x 1,6 x 22,23	—	80 m/s	8500 rpm	25	340944
230 x 1,9 x 22,23	—	80 m/s	6600 rpm	25	340943
230 x 1,9 x 22,23	—	80 m/s	6600 rpm	25	340942

Please observe: Please see Applications Guide on page 224-233, 242.

# Kronenflex® cutting-off wheels 1,6 - 1,9 mm

for hand held machines

Cutting-off wheel INOX

## A 46 TZ SPECIAL



**NEW  
RECIPE**

<b>Class</b>	SPECIAL
<b>Bond</b>	■■■■■■■□
<b>Aggression</b>	■■■■■■■□
<b>Service life</b>	■■■■■■■□

<b>Applications:</b>	
Stainless steel	●
Steel	●

**Advantages:** Free of iron, sulphur and chlorine - Universal use on steel and stainless steel - First choice for professional applications and fast cutting of demanding materials

Diameter x Width x Bore in mm	Form	Max. operating speed	Max. RPM	Packing unit/pcs.	Cat. number
100 x 1,6 x 16	—	80 m/s	15300 rpm	25	194071
115 x 1,6 x 22,23	—	80 m/s	13300 rpm	25	187170
115 x 1,6 x 22,23	—	80 m/s	13300 rpm	25	235378
125 x 1,6 x 22,23	—	80 m/s	12200 rpm	25	187171
125 x 1,6 x 22,23	—	80 m/s	12200 rpm	25	235379
150 x 1,6 x 22,23	—	80 m/s	10200 rpm	25	241472
180 x 1,6 x 22,23	—	80 m/s	8500 rpm	25	221161
230 x 1,9 x 22,23	—	80 m/s	6600 rpm	25	224084
230 x 1,9 x 22,23	—	80 m/s	6600 rpm	25	265044

Cutting-off wheel

## A 946 TZ SPECIAL



**NEW**

<b>Class</b>	SPECIAL
<b>Bond</b>	■■■■■■■
<b>Aggression</b>	■■■■■■■
<b>Service life</b>	■■■■■■■

<b>Applications:</b>	
Steel	●
Stainless steel	●
NF metals	○
Castings	○

**Advantages:** Free of iron, sulfur and chlorine - Extra long service life across all applications - For universal use in metal processing - Short cutting times - Low burr formation - Low thermal load - 25 pieces delivered in the Kronenflex® box for long lasting high performance and moisture protection

Diameter x Width x Bore in mm	Form	Max. operating speed	Max. RPM	Packing unit/pcs.	Cat. number
100 x 1,6 x 16	—	80 m/s	15300 rpm	25	339103
115 x 1,6 x 22,23	—	80 m/s	13300 rpm	25	339109
125 x 1,6 x 22,23	—	80 m/s	12200 rpm	25	339110
150 x 1,6 x 22,23	—	80 m/s	10200 rpm	25	339111
180 x 1,6 x 22,23	—	80 m/s	8500 rpm	25	339112
230 x 1,9 x 22,23	—	80 m/s	6600 rpm	25	339113
230 x 1,9 x 22,23	—	80 m/s	6600 rpm	25	339114

Please observe: Please see Applications Guide on page 224-233, 242.

Wheel flange

## FL 76



**Advantages:** Use of the wheel flange increases lateral stability with thin cutting-off wheels having a flat form and diameters of 180 and 230 mm

Diameter in mm	Suitable for	Packing unit/pcs.	Cat. number
76	A 46 TZ + A 646 R + A 946 TZ	1	236130



# Kronenflex® cutting-off wheels

## 2,0 – 3,2 mm

### About the product

Klingspor Kronenflex® cutting-off wheels with a disc thickness of 2,0 to 3,2 mm are known for their particularly high lateral stability.

This is particularly important for applications which require deep cuts into solid material – e.g. to cut risers/casts or large profiles. The enormous lateral forces that occur while working require particularly high cutting-off wheel stability.

Despite their thickness, Klingspor Kronenflex cutting-off wheels of the 2,0 to 3,2 mm class are known for their excellent cutting rate and long service life. These cutting-off wheels are ideal for applications that require a high degree of lateral stability.

### Typical materials for these products

- ▶ Steel
- ▶ Stainless steel
- ▶ Construction steel
- ▶ NF metals
- ▶ Cast materials
- ▶ Stone
- ▶ Plastics
- ▶ Mineral materials
- ▶ Solid materials
- ▶ Pipes
- ▶ Flat irons
- ▶ Tins

### Typical applications for these products

- ▶ Foundries
- ▶ Locksmiths
- ▶ Shipyards
- ▶ Steelwork
- ▶ Plant construction
- ▶ Metal works
- ▶ Maintenance and repair work

#### Material applications

Type	Thickness [mm]	Steel	Hardened steels	Tool steel	Stainless steel	High alloy steels	Corrosion and acid proof steels	Aluminium	Bronze	Copper	Brass	Zinc die-casting	Cast iron	Stone / concrete	Page
A 24 EXTRA	2,0–3,2	●	○	●	○	○	○	○	○	○	○	○	○		247
A 24 R SUPRA	2,5–3,0	●	●	●	○	○	○					○	○		248
A 24 N SUPRA INOX	2,5–3,0	○	●	○	●	●	●	○	○	○	○				249
A 36 R SUPRA INOX	2,0–2,5	○	○	●	●	●	●		○	○	○				249
A 36 TZ SPECIAL INOX	2,0	○	○	●	●	●	●						○		250
A 24 R/36 SPECIAL INOX	2,5–3,0	○	○	●	●	●	●								251
A 24 TZ SPECIAL	2,5–3,0	○		○	●	●	●						○		250
A 46 N SUPRA	2,5–3,0							●	●	●	●	○			251
C 24 EXTRA	2,5–3,0													●	252
C 24 R SUPRA	2,5–3,0												○	●	252

● = main application ○ = possible applications

# Kronenflex® cutting-off wheels 2,0 - 3,2 mm for hand held machines



Cutting-off wheel

## A 24 EXTRA



<b>Class</b>	EXTRA
Bond	■ ■ ■ ■ □ □ □ □
Aggression	■ ■ ■ ■ □ □ □ □
Service life	■ ■ ■ ■ □ □ □ □

<b>Applications:</b>	
Metals	●

**Advantages:** Proven a million times over - Standard wheel with outstanding price-performance ratio - For universal use in metalworking - Fast cutting off of solid material

Diameter x Width x Bore in mm	Form	Max. operating speed	Max. RPM	Packing unit/pcs.	Cat. number
100 x 2,5 x 16		80 m/s	15300 rpm	25	188998
115 x 2,5 x 22,23		80 m/s	13300 rpm	25	242137
115 x 2,5 x 22,23		80 m/s	13300 rpm	25	188461
115 x 3,2 x 22,23		80 m/s	13300 rpm	25	209014
125 x 2,5 x 22,23		80 m/s	12200 rpm	25	242138
125 x 2,5 x 22,23		80 m/s	12200 rpm	25	188463
125 x 3,2 x 22,23		80 m/s	12200 rpm	25	209016
150 x 2,5 x 22,23		80 m/s	10200 rpm	25	235375
150 x 2,5 x 22,23		80 m/s	10200 rpm	25	235374
180 x 2 x 22,23		80 m/s	8500 rpm	25	286455
180 x 3 x 22,23		80 m/s	8500 rpm	25	13490
180 x 3 x 22,23		80 m/s	8500 rpm	25	189000
230 x 2 x 22,23		80 m/s	6600 rpm	25	286456
230 x 3 x 22,23		80 m/s	6600 rpm	25	13492
230 x 3 x 22,23		80 m/s	6600 rpm	25	189002

Please observe: Please see Applications Guide on page 224-233, 246.

# Kronenflex® cutting-off wheels 2,0 - 3,2 mm

for hand held machines

Cutting-off wheel

## A 24 R

### SUPRA



Class	SUPRA		Applications:
Bond	■ ■ ■ ■ ■ ■ ■ ■	□ □	Steel ●
Aggression	■ ■ ■ ■ ■ ■ ■ ■	□ □	Stainless steel ○
Service life	■ ■ ■ ■ ■ ■ ■ ■	□ □	Castings ○

**Advantages:** Optimized combination for use on steel - Can be used on stainless steel - Good cutting properties

Diameter x Width x Bore in mm	Form	Max. operating speed	Max. RPM	Packing unit/pcs.	Cat. number
100 x 2,5 x 16		80 m/s	15300 rpm	25	13754
115 x 2,5 x 22,23		80 m/s	13300 rpm	25	13297
115 x 2,5 x 22,23		80 m/s	13300 rpm	25	13466
125 x 2,5 x 22,23		80 m/s	12200 rpm	25	13295
125 x 2,5 x 22,23		80 m/s	12200 rpm	25	13738
150 x 2,5 x 22,23		80 m/s	10200 rpm	25	6667
180 x 3 x 22,23		80 m/s	8500 rpm	25	13456
180 x 3 x 22,23		80 m/s	8500 rpm	25	13470
180 x 3,5 x 22,23		80 m/s	8500 rpm	25	13474
230 x 3 x 22,23		80 m/s	6600 rpm	25	13464
230 x 3 x 22,23		80 m/s	6600 rpm	25	13478

Please observe: Please see Applications Guide on page 224-233, 246.

# Kronenflex® cutting-off wheels 2,0 - 3,2 mm for hand held machines



Cutting-off wheel INOX

## A 24 N SUPRA



Class	SUPRA	Applications:
Bond	■ ■ ■ ■ □ □ □ □	Stainless steel ●
Aggression	■ ■ ■ ■ ■ □ □ □	Aluminium ○
Service life	■ ■ ■ ■ ■ □ □ □	

**Advantages:** Special recipe prevents smearing and clogging - High removal rate on stainless steel due to hardened aluminium oxide

Diameter x Width x Bore in mm	Form	Max. operating speed	Max. RPM	Packing unit/pcs.	Cat. number
115 x 2,5 x 22,23		80 m/s	13300 rpm	25	3020
125 x 2,5 x 22,23		80 m/s	12200 rpm	25	2951
150 x 2,5 x 22,23		80 m/s	10200 rpm	25	235377
180 x 3 x 22,23		80 m/s	8500 rpm	25	13455
180 x 3 x 22,23		80 m/s	8500 rpm	25	13469
230 x 3 x 22,23		80 m/s	6600 rpm	25	13463
230 x 3 x 22,23		80 m/s	6600 rpm	25	13477

Cutting-off wheel INOX

## A 36 R SUPRA



Class	SUPRA	Applications:
Bond	■ ■ ■ ■ □ □ □ □	Stainless steel ●
Aggression	■ ■ ■ ■ ■ □ □ □	
Service life	■ ■ ■ ■ ■ □ □ □	

**Advantages:** Excellent cutting performance - Optimized aggression and service life

Diameter x Width x Bore in mm	Form	Max. operating speed	Max. RPM	Packing unit/pcs.	Cat. number
115 x 2 x 22,23		80 m/s	13300 rpm	25	123208
125 x 2 x 22,23		80 m/s	12200 rpm	25	126849
150 x 2 x 22,23		80 m/s	10200 rpm	25	251752
180 x 2,5 x 22,23		80 m/s	8500 rpm	25	123209
230 x 2,5 x 22,23		80 m/s	6600 rpm	25	123833

Please observe: Please see Applications Guide on page 224-233, 246.

# Kronenflex® cutting-off wheels 2,0 - 3,2 mm

for hand held machines

Cutting-off wheel INOX

## A 36 TZ SPECIAL



Class	SPECIAL		Applications:
Bond	■ ■ ■ ■ ■ ■ ■ ■	□	Stainless steel ●
Aggression	■ ■ ■ ■ ■ ■ ■ ■		Steel ○
Service life	■ ■ ■ ■ ■ ■ ■ ■	□ □	

**Advantages:** Very good cutting performance, even with low grinding pressure

Diameter x Width x Bore in mm	Form	Max. operating speed	Max. RPM	Packing unit/pcs.	Cat. number
115 x 2 x 22,23		80 m/s	13300 rpm	25	136549
125 x 2 x 22,23		80 m/s	12200 rpm	25	136550
180 x 2 x 22,23		80 m/s	8500 rpm	25	136551
230 x 2 x 22,23		80 m/s	6600 rpm	25	136552

Cutting-off wheel INOX

## A 24 TZ SPECIAL



Class	SPECIAL		Applications:
Bond	■ ■ ■ ■ ■ ■ ■ ■	□	Stainless steel ●
Aggression	■ ■ ■ ■ ■ ■ ■ ■	□ □	Steel ○
Service life	■ ■ ■ ■ ■ ■ ■ ■	□	Castings ○

**Advantages:** Optimized combination for use on stainless steel - Excellent performance

Diameter x Width x Bore in mm	Form	Max. operating speed	Max. RPM	Packing unit/pcs.	Cat. number
115 x 2,5 x 22,23		80 m/s	13300 rpm	25	136554
125 x 2,5 x 22,23		80 m/s	12200 rpm	25	136555
180 x 3 x 22,23		80 m/s	8500 rpm	25	136558
230 x 3 x 22,23		80 m/s	6600 rpm	25	136559

Please observe: Please see Applications Guide on page 224-233, 246.

# Kronenflex® cutting-off wheels 2,0 - 3,2 mm for hand held machines



Cutting-off wheels

Cutting-off wheel INOX

## A 24 R/36 SPECIAL



<b>Class</b>	SPECIAL
Bond	■ ■ ■ ■ □ □ □ □
Aggression	■ ■ ■ ■ ■ □ □ □
Service life	■ ■ ■ ■ ■ □ □ □

<b>Applications:</b>	
Stainless steel	●

**Advantages:** Special wheel for the nuclear industry - Free of iron, sulphur and chlorine

Diameter x Width x Bore in mm	Form	Max. operating speed	Max. RPM	Packing unit/pcs.	Cat. number
115 x 2,5 x 22,23		80 m/s	13300 rpm	25	60534
125 x 2,5 x 22,23		80 m/s	12200 rpm	25	2825
180 x 3 x 22,23		80 m/s	8500 rpm	25	60537
230 x 3 x 22,23		80 m/s	6600 rpm	25	60061

Cutting-off wheel

## A 46 N SUPRA



<b>Class</b>	SUPRA
Bond	■ ■ ■ □ □ □ □ □
Aggression	■ ■ ■ ■ ■ □ □ □
Service life	■ ■ ■ ■ ■ □ □ □

<b>Applications:</b>	
Aluminium	●

**Advantages:** Special combination prevents smearing and clogging - Optimized cutting off performance on non-ferrous metals

Diameter x Width x Bore in mm	Form	Max. operating speed	Max. RPM	Packing unit/pcs.	Cat. number
115 x 2,5 x 22,23		80 m/s	13300 rpm	25	170707
125 x 2,5 x 22,23		80 m/s	12200 rpm	25	170708
180 x 3 x 22,23		80 m/s	8500 rpm	25	170709
230 x 3 x 22,23		80 m/s	6600 rpm	25	170710

Please observe: Please see Applications Guide on page 224-233, 246.



# Kronenflex® cutting-off wheels 2,0 - 3,2 mm

for hand held machines

Cutting-off wheel

## C 24 EXTRA



<b>Class</b>	EXTRA
<b>Bond</b>	■ ■ ■ ■ □ □ □ □
<b>Aggression</b>	■ ■ ■ ■ □ □ □ □
<b>Service life</b>	■ ■ ■ ■ □ □ □ □

<b>Applications:</b>	
Stone/Concrete	●

**Advantages:** Universal cutting-off wheel for all mineral materials - Wide application range due to sharp, coarse SiC grit

Diameter x Width x Bore in mm	Form	Max. operating speed	Max. RPM	Packing unit/pcs.	Cat. number
100 x 2,5 x 16		80 m/s	15300 rpm	25	188999
115 x 2,5 x 22,23		80 m/s	13300 rpm	25	242143
115 x 2,5 x 22,23		80 m/s	13300 rpm	25	188462
125 x 2,5 x 22,23		80 m/s	12200 rpm	25	242144
125 x 2,5 x 22,23		80 m/s	12200 rpm	25	188464
180 x 3 x 22,23		80 m/s	8500 rpm	25	13489
180 x 3 x 22,23		80 m/s	8500 rpm	25	189001
230 x 3 x 22,23		80 m/s	6600 rpm	25	13491
230 x 3 x 22,23		80 m/s	6600 rpm	25	189003

Cutting-off wheel

## C 24 R SUPRA



<b>Class</b>	SUPRA
<b>Bond</b>	■ ■ ■ ■ □ □ □ □
<b>Aggression</b>	■ ■ ■ ■ □ □ □ □
<b>Service life</b>	■ ■ ■ ■ □ □ □ □

<b>Applications:</b>	
Stone/Concrete	●
Castings	⦿

**Advantages:** Optimal for all mineral materials due to sharp, coarse SiC grit

Diameter x Width x Bore in mm	Form	Max. operating speed	Max. RPM	Packing unit/pcs.	Cat. number
115 x 2,5 x 22,23		80 m/s	13300 rpm	25	13465
125 x 2,5 x 22,23		80 m/s	12200 rpm	25	13739
230 x 3 x 22,23		80 m/s	6600 rpm	25	13461
230 x 3 x 22,23		80 m/s	6600 rpm	25	13475

Please observe: Please see Applications Guide on page 224-233, 246.

# Notes



---

A large grid of small dots for taking notes.

# Kronenflex® large cutting-off wheels

## About the product

Klingspor Kronenflex large cutting-off wheels are high performance, robust wheels for special uses with an outer diameter of 300 mm and more.

Their high lateral stability ensures safe operation also in connection with hard cutting applications. The optimised grits and resins are specifically created for the specific application areas. The cutting-off wheels are known for their fast cuts and low thermal material loads, as well as their long service life.

Klingspor Kronenflex large cutting-off wheels uses range from bench cutting to handheld machines, from railway construction to industrial uses on stationary machines. These products are the ideal solution if outstanding performance and a high degree of safety is what is needed.

Type	Thick-ness [mm]	Material applications											Machines				Page			
		Steel	Hardened steels	Tool steel	Stainless steel	High alloy steels	Corrosion and acid proof steels	Aluminium	Bronze	Copper	Brass	Zinc die-casting	Cast iron	Stone / concrete	Asphalt	Bench chop saws		Handheld machines 80m/s	Handheld machines 100m/s	Stationary < 5KW
A 24 EXTRA	3,5	●	○	●	○	○	○						○				●			257
C 24 EXTRA	3,5												○	●	○		●			257
A 330 EXTRA	2,5	●	○	○	○	○	○									●				261
A 24 R SUPRA	3,0-4,5	●	●	●	○	○	○						○						●	260
A 24 N SUPRA INOX	3,5	○	●	●	●	●	●	○	○	○	○	○							●	260
A 630 N SUPRA	2,5	●	○	○	○	○	○									●				261
A 24 R SPECIAL	3,5-4,0	●	●	●	●	●	●						○				●			258
T 24 AX SPECIAL	3,5-4,0	●	●															●		259
C 24 RA SPECIAL	3,5-4,0												○	●			●			258
A 30 N SPECIAL	2,5-3,5	●	○	○	○	○	○	○	○	○	○	○				●				262

● = main application ○ = possible applications

## Cutting-off wheels for different types of machines

- ▶ Handheld machines 80m/s
- ▶ Handheld machines with a clamping device for vignole rails 100m/s
- ▶ Transportable bench chop saws < 3KW
- ▶ Stationary saws / cutters up to 5KW
- ▶ Stationary saws / cutters > 5KW

**Stationary cutting-off wheels may not be used with freehand machines.**

## Products for handheld machines

These products were developed for use with handheld machines (petrol, electric, high frequency).

Please note that it is very important that the maximum operating speed setting on the machines and the maximum operating speed setting on the products match. 80 m/s and 100 m/s machines are available on the market. Klingspor large cutting-off wheels for handheld machines are certified for 80 m/s handheld machines. Products for railway construction with a clamping device are certified up to 100 m/s.

## Products for transportable bench chop saws

Cutting-wheels for this product group are suitable for low power bench chop saws. These products may not be used with large stationary and / or handheld machines.

They are known for their high cutting rate, which ensures fast and cool cutting.

## Products for stationary saws / cutters

Stationary machines are best suited for economical and safe cutting of large cross sections and heavy workpieces.

Products in this segment with their outstanding performance and long service life fulfil the most demanding requirements of stationary cutting. Good aggressiveness ensures low thermal loads when working on large cross sections.

# Kronenflex® large cutting-off wheels

## Applications guide

### Which cutting-off wheel is used with which machine?

Large cutting-off wheels for stationary machines and large cutting-off wheels for handheld machines are designed differently and their build is optimised for the respective machine type. For safety reasons large cutting-off wheels for stationary machines may never be used with handheld machines.

The bore diameter of a large cutting-off wheel does not indicate if it is a wheel that can be used with a stationary machine or if it is a wheel that can be used with a handheld machine.

A binding overview regarding which Klingspor wheel type is to be used with which machine type is provided in the table below.

Type	Ø [mm]	Thickness [mm]	Bore Ø [mm]	Machines	Safety	
					Max. operating speed	Application type (EN12413)
<b>A 24 EXTRA</b>	300	3,5	20/22,23	general handheld machines (petrol, electric, high frequency)	80 m/s	freehand cutting
<b>C 24 EXTRA</b>	300	3,5	20/22,23		80 m/s	
<b>A 330 EXTRA</b>	350	2,5	25,4	transportable bench chop saws, chop saws	80 m/s	stationary guided cutting <3 KW
<b>A 630 N SUPRA</b>	350	2,5	25,4	transportable bench chop saws, chop saws	80 m/s	stationary guided cutting <3 KW
<b>A 24 R SUPRA</b>	250	3	32	stationary saws / cutters	100 m/s	>3 KW
	300	3	22,23/25,4/30/32		100 m/s	>3 KW
	350	3,5	25,4/32		100 m/s	stationary guided cutting >3 KW
	400	4,5	25,4/32/40		100 m/s	>3 KW
<b>A 24 N SUPRA</b>	350	3,5	25,4		100 m/s	>3 KW
<b>A 24 R/06 SUPRA</b>	400	4	25,4		100 m/s	>5 KW
<b>A 24 R SPECIAL</b>	300	3,5	20/22, 23/25,4	general handheld machines (petrol, electric, high frequency)	80 m/s	freehand cutting
	350	4	20/22, 23/25,4		80 m/s	
<b>T 24 AX SPECIAL</b>	300	3,5	22,23	general handheld machines (petrol, electric, high frequency, hydraulic) with a clamping device	100 m/s	stationary guided cutting
	350	4	22,23/25,4		100 m/s	
	400	4,5	25,4		100 m/s	
<b>C 24 RA SPECIAL</b>	300	3,5	20	general handheld machines, joint cutters (petrol, electric, high frequency)	80 m/s	freehand cutting
	350	4	20/25,4		80 m/s	
<b>A 30 N SPECIAL</b>	300	2,5	25,4	transportable bench chop saws, chop saws	80 m/s	<3 KW
	350	3	25,4		80 m/s	stationary guided cutting <3 KW
	400	3,5	25,4		80 m/s	<3 KW

# Kronenflex® large cutting-off wheels

for petrol driven saw / cutter



Cutting-off wheels

Cutting-off wheel

## A 24 EXTRA



<b>Class</b>	EXTRA
Bond	■ ■ ■ ■ □ □ □ □
Aggression	■ ■ ■ ■ □ □ □ □
Service life	■ ■ ■ ■ □ □ □ □

<b>Applications:</b>	
Metals	●

**Advantages:** Standard wheel with outstanding price-performance ratio - For universal use in metalworking - For use on gas powered freehand machines with a cutting speed of 80 m/s

Diameter x Width x Bore in mm	Form	Max. operating speed	Max. RPM	Packing unit/pcs.	Cat. number
300 x 3,5 x 20	—	80 m/s	5100 rpm	10	288221
300 x 3,5 x 22,23	—	80 m/s	5100 rpm	10	288222

Cutting-off wheel

## C 24 EXTRA



<b>Class</b>	EXTRA
Bond	■ ■ ■ ■ □ □ □ □
Aggression	■ ■ ■ ■ □ □ □ □
Service life	■ ■ ■ ■ □ □ □ □

<b>Applications:</b>	
Stone/Concrete	●

**Advantages:** Optimal for all mineral materials due to sharp, coarse SiC grit - For use on gas powered freehand machines with a cutting speed of 80 m/s

Diameter x Width x Bore in mm	Form	Max. operating speed	Max. RPM	Packing unit/pcs.	Cat. number
300 x 3,5 x 20	—	80 m/s	5100 rpm	10	288223
300 x 3,5 x 22,23	—	80 m/s	5100 rpm	10	288224

Please observe: Please see Applications Guide on page 224-233, 254-256.



# Kronenflex® large cutting-off wheels

for petrol driven saw / cutter

Cutting-off wheel

## A 24 R SPECIAL



<b>Class</b>	SPECIAL		<b>Applications:</b>	
Bond	■ ■ ■ ■ ■ ■ □ □		Steel	●
Aggression	■ ■ ■ ■ ■ □ □		Stainless steel	◐
Service life	■ ■ ■ ■ ■ □ □		Castings	◐

**Advantages:** Fast cutting, also of solid material - Optimized combination for use on steel - Can be also used on stainless steel - For use on gas powered freehand machines with a cutting speed of 80 m/s

Diameter x Width x Bore in mm	Form	Max. operating speed	Max. RPM	Packing unit/pcs.	Cat. number
300 x 3,5 x 20	—	80 m/s	5100 rpm	10	288245
300 x 3,5 x 22,23	—	80 m/s	5100 rpm	10	288246
300 x 3,5 x 25,4	—	80 m/s	5100 rpm	10	288247
350 x 4 x 20	—	80 m/s	4400 rpm	10	288248
350 x 4 x 22,23	—	80 m/s	4400 rpm	10	288249
350 x 4 x 25,4	—	80 m/s	4400 rpm	10	288250

Cutting-off wheel

## C 24 RA SPECIAL



<b>Class</b>	SPECIAL		<b>Applications:</b>	
Bond	■ ■ ■ ■ ■ □ □		Asphalt	●
Aggression	■ ■ ■ ■ ■ □ □		Stone/Concrete	◐
Service life	■ ■ ■ ■ ■ □ □			

**Advantages:** Special combination for asphalt - No clogging - Sharp, coarse SiC grain - For use on gas powered freehand machines with a cutting speed of 80 m/s

Diameter x Width x Bore in mm	Form	Max. operating speed	Max. RPM	Packing unit/pcs.	Cat. number
300 x 3,5 x 20	—	80 m/s	5100 rpm	10	288251
350 x 4 x 20	—	80 m/s	4400 rpm	10	288252
350 x 4 x 25,4	—	80 m/s	4400 rpm	10	288253

Please observe: Please see Applications Guide on page 224-233, 254-256.

# Kronenflex® large cutting-off wheels

for petrol driven saw / cutter with clamping device



Cutting-off wheel

## T 24 AX SPECIAL



<b>Class</b>	SPECIAL		<b>Applications:</b>	
Bond	■ ■ ■ ■ ■ ■ ■ ■	□	Steel	●
Aggression	■ ■ ■ ■ ■ ■ ■ ■	□		
Service life	■ ■ ■ ■ ■ ■ ■ ■	□		

**Advantages:** For universal use on all rail types - Very fast cutting - Maximum aggressiveness and service life due to hardened special aluminum oxide - For use on gas powered cutting-off machines with a cutting speed of 100 m/s and clamping device

Diameter x Width x Bore in mm	Form	Max. operating speed	Max. RPM	Packing unit/pcs.	Cat. number
300 x 3,5 x 22,23	— —	100 m/s	6400 rpm	10	314012
350 x 4 x 22,23	— —	100 m/s	5500 rpm	10	314013
350 x 4 x 25,4	— —	100 m/s	5500 rpm	10	314014
400 x 4 x 25,4	— —	100 m/s	4800 rpm	10	314035

Please observe: Please see Applications Guide on page 224-233, 254-256.

# Kronenflex® large cutting-off wheels

for stationary cutting

Cutting-off wheel

## A 24 R SUPRA



**Class** SUPRA

**Bond** ■■■■■□□

**Aggression** ■■■■■□□

**Service life** ■■■■■□□

**Applications:**

Steel ●

Stainless steel ○

Castings ○

**Advantages:** Optimized combination for use on steel - Can be used on stainless steel - Good cutting properties - Optimal for stationary 3 - 5 kW cutting-off machine

Diameter x Width x Bore in mm	Form	Max. operating speed	Max. RPM	Packing unit/pcs.	Cat. number
250 x 3 x 32	—	100 m/s	7600 rpm	10	2465
300 x 3 x 22,23	—	100 m/s	6400 rpm	10	71365
300 x 3 x 25,4	—	100 m/s	6400 rpm	10	6793
300 x 3 x 30	—	100 m/s	6400 rpm	10	13524
300 x 3 x 32	—	100 m/s	6400 rpm	10	6807
350 x 3,5 x 25,4	—	100 m/s	5500 rpm	10	13528
350 x 3,5 x 32	—	100 m/s	5500 rpm	10	13536
400 x 4,5 x 25,4	—	100 m/s	4800 rpm	10	292933
400 x 4,5 x 32	—	100 m/s	4800 rpm	10	292932
400 x 4,5 x 40	—	100 m/s	4800 rpm	10	296567

Cutting-off wheel INOX

## A 24 N SUPRA



**Class** SUPRA

**Bond** ■■■□□□□

**Aggression** ■■■■■□□

**Service life** ■■■■■□□

**Applications:**

Stainless steel ●

Steel ○

Aluminium ○

**Advantages:** Hardened aluminium oxide - Special combination prevents smearing and clogging - Optimal for stationary 3 - 5 kW cutting-off machines

Diameter x Width x Bore in mm	Form	Max. operating speed	Max. RPM	Packing unit/pcs.	Cat. number
350 x 3,5 x 25,4	—	100 m/s	5500 rpm	10	13527

Please observe: Please see Applications Guide on page 224-233, 254-256.

# Kronenflex® large cutting-off wheels

for chop saws



Cutting-off wheels

Cutting-off wheel

## A 330 EXTRA



Class	EXTRA
Bond	■ ■ ■ ■ ■ □ □
Aggression	■ ■ ■ ■ ■ □ □
Service life	■ ■ ■ ■ ■ □ □

Applications:	
Steel	●
Stainless steel	⓪
Aluminium	⓪
Castings	⓪

**NEW**

**Advantages:** More stability during cutting - Good cutting speed with a long service life - Recommended for various materials and different profiles - Usable on transportable chop saw < 3 KW engine power

Diameter x Width x Bore in mm	Form	Max. operating speed	Max. RPM	Packing unit/pcs.	Cat. number
350 x 2,5 x 25,4	—	80 m/s	4400 rpm	10	339069

Cutting-off wheel

## A 630 N SUPRA



Class	SUPRA
Bond	■ ■ ■ ■ ■ □ □
Aggression	■ ■ ■ ■ ■ □ □
Service life	■ ■ ■ ■ ■ □ □

Applications:	
Steel	●
Stainless steel	⓪
Aluminium	⓪
Castings	⓪

**NEW**

**Advantages:** Aggressive model with an outstanding service life - An exceptional choice for 110 volt machines and the cutting of solid material - Bond optimized for universal use - Low thermal load - Minimum burr formation

Diameter x Width x Bore in mm	Form	Max. operating speed	Max. RPM	Packing unit/pcs.	Cat. number
350 x 2,5 x 25,4	—	80 m/s	4400 rpm	10	339070

Please observe: Please see Applications Guide on page 224-233, 254-256.

# Kronenflex® large cutting-off wheels

for chop saws

Cutting-off wheel

## A 30 N SPECIAL



Class	SPECIAL
Bond	■ ■ ■ ■ □ □ □ □
Aggression	■ ■ ■ ■ ■ ■ ■ ■ □
Service life	■ ■ ■ ■ □ □ □ □

Applications:	
Steel	●
Stainless steel	○
Aluminium	○
Castings	○

**Advantages:** For universal use on chop saws - Minimal burr formation - Can be used on table cutting-off machines < 3 kW

Diameter x Width x Bore in mm	Form	Max. operating speed	Max. RPM	Packing unit/pcs.	Cat. number
300 x 2,5 x 25,4	—	80 m/s	5100 rpm	10	119627
350 x 3 x 25,4	—	80 m/s	4400 rpm	10	119628
400 x 3,5 x 25,4	—	80 m/s	3800 rpm	10	119629

Please observe: Please see Applications Guide on page 224-233, 254-256.



---

A large grid of small dots for taking notes.







# Kronenflex® grinding discs

## About the product

Kronenflex® grinding discs are characterised by their permanent high level of attack and maximum stock removal. The optimum relationship between performance and service life is guaranteed up to the complete use of the disc.

Kronenflex® grinding discs are used in all major surface grinding applications, as well as for edge bevelling and burr removal. Klingspor offers professional advice in selecting the right grinding disc for your application.

From general metalworking to material-related applications in steel, stainless steel and NF metals, to the more specialised requirements of the nuclear industry, Klingspor has the products you need. Discs for stone grinding and cup grinding wheels round off our programme.

Our engineers are standing by to help you, should you have specific problems or technical questions. You may take advantage of our technical consulting services whether at Klingspor or directly on site.

## Practical tips

The rule of thumb also applies to grinding discs: the harder the material, the softer the bond of the grinding disc.

In addition, the application plays a very decisive role.

Corners and burrs have very sharp edges and easily tear the grit out of the bond. We recommend the use of a hard bond.

If on the other hand one is working on surfaces i.e. small welded seams, a disc that is too hard would easily become dull and no longer grip the material. The disc would achieve a good service life, but this would result in a low stock removal rate and high work costs.

For finish grinding the best disc bond is a medium or soft disc bond.

Grinding discs

Type	Thickness [mm]	Material applications													Page
		Steel	Hardened steels	Tool steel	Stainless steel	High alloy steels	Corrosion and acid proof steels	Aluminium	Bronze	Copper	Brass	Zinc die-casting	Cast iron	Stone / concrete	
A 24 EXTRA	6,0–8,0	●	○	○	○	○	○					○	○		266
A 24 EXTRA T	6,0–8,0	●	○	○	○	○	○						○		266
A 24 R SUPRA	4,0–10	●	●	●	○	○	○						○		267
A 24 R/01 SPECIAL	4,0	●	●	●	○	○	○								267
A 24 N SUPRA INOX	6,0–8,0	○	●	○	●	●	●								268
A 24 R/36 SPECIAL	6,0	○	○	○	●	●	●								268
A 46 N SUPRA	6,0–8,0							●	○	○	○	○			269
A 46 VZ SPECIAL	2,0	○	○	●	●	●	●					○			269
A 546 AC ACCU	2,0	○	○	●	●	●	●					○			270
A 624 T SUPRA	6,0	●	●	●	●	○	○					○	●		270
A 24 TX SPECIAL	6	○	○	○	○	○	○						●		271
C 24 R SUPRA	6												○	●	271
A 16 R SUPRA	55	●											○		272
A 30 R SUPRA	55	●													272
C 16 R SUPRA	55												○	●	273
C 30 R SUPRA	55												○	●	273

● = main application ○ = possible applications

# Kronenflex® grinding discs

for hand held machines

Grinding disc

## A 24 EXTRA



<b>Class</b>	EXTRA
<b>Bond</b>	■ ■ ■ ■ □ □ □ □
<b>Aggression</b>	■ ■ ■ ■ □ □ □ □
<b>Service life</b>	■ ■ ■ ■ □ □ □ □

<b>Applications:</b>	
Metals	●

**Advantages:** Standard disc with excellent price-performance ratio - For universal use in metal-working - Excellent results on all standard angle grinders

Diameter x Width x Bore in mm	Form	Max. operating speed	Max. RPM	Packing unit/pcs.	Cat. number
100 x 6 x 16		80 m/s	15300 rpm	10	189004
115 x 6 x 22,23		80 m/s	13300 rpm	10	188465
125 x 6 x 22,23		80 m/s	12200 rpm	10	188466
150 x 6 x 22,23		80 m/s	10200 rpm	10	235371
180 x 6 x 22,23		80 m/s	8500 rpm	10	13444
180 x 8 x 22,23		80 m/s	8500 rpm	10	13446
230 x 6 x 22,23		80 m/s	6600 rpm	10	13447
230 x 8 x 22,23		80 m/s	6600 rpm	10	13448

Grinding disc

## A 24 EXTRA T



<b>Class</b>	EXTRA
<b>Bond</b>	■ ■ ■ ■ ■ □ □ □
<b>Aggression</b>	■ ■ ■ □ □ □ □ □
<b>Service life</b>	■ ■ ■ ■ ■ □ □ □

<b>Applications:</b>	
Metals	●

**Advantages:** Extra hard grinding disc - Optimal for edge work and for removal of stubborn burrs

Diameter x Width x Bore in mm	Form	Max. operating speed	Max. RPM	Packing unit/pcs.	Cat. number
180 x 6 x 22,23		80 m/s	8500 rpm	10	13794
180 x 8 x 22,23		80 m/s	8500 rpm	10	13445

Please observe: Please see Applications Guide on page 224-233, 264-265.















Grinding disc

# A 24 R SUPRA



Class	SUPRA	Applications:
Bond	■ ■ ■ ■ □ □ □ □	Steel ●
Aggression	■ ■ ■ ■ ■ □ □ □	Stainless steel ①
Service life	■ ■ ■ ■ ■ □ □ □	Castings ①

**Advantages:** With optimised recipe for use on steel - Also suitable for use on stainless steel - Large product range

Diameter x Width x Bore in mm	Form	Max. operating speed	Max. RPM	Packing unit/pcs.	Cat. number
100 x 4 x 16		80 m/s	15300 rpm	10	13400
100 x 6 x 16		80 m/s	15300 rpm	10	6578
115 x 4 x 22,23		80 m/s	13300 rpm	10	13746
115 x 6 x 22,23		80 m/s	13300 rpm	10	13401
125 x 4 x 22,23		80 m/s	12200 rpm	10	240831
125 x 6 x 22,23		80 m/s	12200 rpm	10	13402
150 x 6 x 22,23		80 m/s	10200 rpm	10	13403
180 x 10 x 22,23		80 m/s	8500 rpm	10	13423
180 x 4 x 22,23		80 m/s	8500 rpm	10	13408
180 x 7 x 22,23		80 m/s	8500 rpm	10	13413
180 x 8 x 22,23		80 m/s	8500 rpm	10	13418
230 x 4 x 22,23		80 m/s	6600 rpm	10	13428
230 x 6 x 22,23		80 m/s	6600 rpm	10	13433
230 x 8 x 22,23		80 m/s	6600 rpm	10	13438



Grinding disc

# A 24 R/01 SPECIAL



Class	SPECIAL	Applications:
Bond	■ ■ ■ ■ □ □ □ □	Steel ●
Aggression	■ ■ ■ ■ ■ □ □ □	Stainless steel ①
Service life	■ ■ ■ □ □ □ □ □	

**Advantages:** Special disc for pipeline and tank construction - Suitable for root seams - For repair of weld seams

Diameter x Width x Bore in mm	Form	Max. operating speed	Max. RPM	Packing unit/pcs.	Cat. number
125 x 4 x 22,23		80 m/s	12200 rpm	10	130825
180 x 4 x 22,23		80 m/s	8500 rpm	10	13756

Please observe: Please see Applications Guide on page 224-233, 264-265.



# Kronenflex® grinding discs

for hand held machines

Grinding disc INOX

## A 24 N SUPRA



<b>Class</b>	SUPRA
Bond	■ ■ ■ ■ □ □ □ □
Aggression	■ ■ ■ ■ ■ □ □ □
Service life	■ ■ ■ ■ □ □ □ □

<b>Applications:</b>	
Stainless steel	●
Aluminium	○

**Advantages:** High removal rate on stainless steel - Optimal ratio between removal and wear

Diameter x Width x Bore in mm	Form	Max. operating speed	Max. RPM	Packing unit/pcs.	Cat. number
115 x 6 x 22,23		80 m/s	13300 rpm	10	2923
125 x 6 x 22,23		80 m/s	12200 rpm	10	2922
180 x 4 x 22,23		80 m/s	8500 rpm	10	13407
180 x 6 x 22,23		80 m/s	8500 rpm	10	13412
180 x 8 x 22,23		80 m/s	8500 rpm	10	13417
230 x 6 x 22,23		80 m/s	6600 rpm	10	13432

Grinding disc

## A 24 R/36 SPECIAL



<b>Class</b>	SPECIAL
Bond	■ ■ ■ ■ □ □ □ □
Aggression	■ ■ ■ ■ ■ □ □ □
Service life	■ ■ ■ ■ □ □ □ □

<b>Applications:</b>	
Stainless steel	●

**Advantages:** Special wheel for the nuclear industry - Free of iron, sulfur and chlorine - Optimal ratio between removal and wear

Diameter x Width x Bore in mm	Form	Max. operating speed	Max. RPM	Packing unit/pcs.	Cat. number
115 x 6 x 22,23		80 m/s	13300 rpm	10	2488
125 x 6 x 22,23		80 m/s	12200 rpm	10	2830
180 x 6 x 22,23		80 m/s	8500 rpm	10	2463

Please observe: Please see Applications Guide on page 224-233, 264-265.





Grinding disc

## A 46 N SUPRA



<b>Class</b>	SUPRA	<b>Applications:</b>
Bond	■ ■ ■ ■ □ □ □ □	Aluminium ●
Aggression	■ ■ ■ ■ ■ □ □ □	NF metals ①
Service life	■ ■ ■ ■ □ □ □ □	

**Advantages:** No clogging when used on non-ferrous metals - Optimal ratio between removal and wear

Diameter x Width x Bore in mm	Form	Max. operating speed	Max. RPM	Packing unit/pcs.	Cat. number
115 x 6 x 22,23		80 m/s	13300 rpm	10	6622
125 x 6 x 22,23		80 m/s	12200 rpm	10	2226
180 x 6 x 22,23		80 m/s	8500 rpm	10	13410
180 x 8 x 22,23		80 m/s	8500 rpm	10	13415



Thin cutting-off wheel & grinding disc

## A 46 VZ SPECIAL



<b>Class</b>	SPECIAL	<b>Applications:</b>
Bond	■ ■ ■ ■ ■ □ □ □	Stainless steel ●
Aggression	■ ■ ■ ■ ■ □ □ □	Steel ●
Service life	■ ■ ■ ■ ■ □ □ □	NF metals ①

**Advantages:** Long service life - Multi-purpose: cutting off and light rough grinding with one wheel - High aggressiveness in cutting - No change of wheel necessary

Diameter x Width x Bore in mm	Form	Max. operating speed	Max. RPM	Packing unit/pcs.	Cat. number
115 x 2 x 22,23		80 m/s	13300 rpm	25	298176
125 x 2 x 22,23		80 m/s	12200 rpm	25	298177



# Kronenflex® grinding discs

for hand held machines

Thin cutting-off wheel & grinding disc

## A 546 AC

ACCU



Class	ACCU	Applications:
Bond	■ ■ ■ ■ ■ ■ □ □	Stainless steel ●
Aggression	■ ■ ■ ■ ■ ■ □ □	Steel ●
Service life	■ ■ ■ ■ ■ ■ □ □	NF metals ●

**Advantages:** Combination disc - Cutting and light grinding applications without disc change - Optimized aggressiveness for all battery-powered angle grinders

ACCU

Diameter x Width x Bore in mm	Form	Max. operating speed	Max. RPM	Packing unit/pcs.	Cat. number
115 x 2 x 22,23		80 m/s	13300 rpm	25	331283
125 x 2 x 22,23		80 m/s	12200 rpm	25	331284

Grinding disc

## A 624 T

SUPRA



Class	SUPRA	Applications:
Bond	■ ■ ■ ■ ■ ■ □ □	Steel ●
Aggression	■ ■ ■ ■ □ □ □ □	Stainless steel ●
Service life	■ ■ ■ ■ ■ ■ □ □	Castings ●

**Advantages:** Special recipe for use on various materials - Optimal ratio between removal and wear

Diameter x Width x Bore in mm	Form	Max. operating speed	Max. RPM	Packing unit/pcs.	Cat. number
115 x 6 x 22,23		80 m/s	13300 rpm	10	325215
125 x 6 x 22,23		80 m/s	12200 rpm	10	325216
180 x 6 x 22,23		80 m/s	8500 rpm	10	325217
230 x 6 x 22,23		80 m/s	6600 rpm	10	325218

Please observe: Please see Applications Guide on page 224-233, 264-265.



Grinding disc

## A 24 TX SPECIAL



Class	SPECIAL	Applications:
Bond	■ ■ ■ ■ ■ ■ ■ □	Castings ●
Aggression	■ ■ ■ □ □ □ □ □	Stainless steel ①
Service life	■ ■ ■ ■ ■ □ □ □	Steel ①

**Advantages:** Ideal for use on cast parts - High aggressiveness and long service life due to hardened aluminium oxide

Diameter x Width x Bore in mm	Form	Max. operating speed	Max. RPM	Packing unit/pcs.	Cat. number
125 x 6 x 22,23		80 m/s	12200 rpm	10	231251
230 x 6 x 22,23		80 m/s	6600 rpm	10	231254



Grinding disc

## C 24 R SUPRA



Class	SUPRA	Applications:
Bond	■ ■ ■ □ □ □ □ □	Stone/Concrete ●
Aggression	■ ■ ■ ■ □ □ □ □	Castings ①
Service life	■ ■ ■ ■ □ □ □ □	

**Advantages:** Ideal for use on stone and mineral materials - High removal rate due to sharp, coarse SiC grain

Diameter x Width x Bore in mm	Form	Max. operating speed	Max. RPM	Packing unit/pcs.	Cat. number
115 x 6 x 22,23		80 m/s	13300 rpm	10	6664
125 x 6 x 22,23		80 m/s	12200 rpm	10	6665
180 x 6 x 22,23		80 m/s	8500 rpm	10	13409

# Kronenflex® cup grinding wheels

for hand held machines

Cup grinding wheel

## A 16 R SUPRA



<b>Class</b>	SUPRA		<b>Applications:</b>
Bond	■ ■ ■ ■ □ □ □ □	Steel	●
Aggression	■ ■ ■ ■ □ □ □ □	Castings	○
Service life	■ ■ ■ □ □ □ □ □		

**Advantages:** For surface grinding and finish grinding of weld seams - Coarse grain for optimized aggressiveness

Diameter x Height x Bore in mm	Form	Max. operating speed	Max. RPM	Packing unit/pcs.	Cat. number
110 x 55 x 22,23		50 m/s	8600 rpm	6	13729

Cup grinding wheel

## A 30 R SUPRA



<b>Class</b>	SUPRA		<b>Applications:</b>
Bond	■ ■ ■ ■ □ □ □ □	Steel	●
Aggression	■ ■ ■ ■ □ □ □ □		
Service life	■ ■ ■ □ □ □ □ □		

**Advantages:** For surface grinding and finish grinding of weld seams - Optimized aggressiveness and long service life

Diameter x Height x Bore in mm	Form	Max. operating speed	Max. RPM	Packing unit/pcs.	Cat. number
110 x 55 x 22,23		50 m/s	8600 rpm	6	13728

**Please observe: Use only on angle grinders with cup grinding wheel guard!**

**Please see Applications Guide on page 224-233, 264-265.**

# Kronenflex® cup grinding wheels

for hand held machines



Cup grinding wheel

## C 16 R SUPRA



<b>Class</b>	SUPRA		<b>Applications:</b>
Bond	■ ■ ■ ■ □ □ □ □	Stone/Concrete	●
Aggression	■ ■ ■ ■ □ □ □ □	Castings	ⓘ
Service life	■ ■ ■ □ □ □ □ □		

**Advantages:** For use on surfaces and edges - For stone and mineral materials - Optimized aggressiveness due to sharp, coarse SiC grain

Diameter x Height x Bore in mm	Form	Max. operating speed	Max. RPM	Packing unit/pcs.	Cat. number
110 x 55 x 22,23		50 m/s	8600 rpm	6	13727

Cup grinding wheel

## C 30 R SUPRA



<b>Class</b>	SUPRA		<b>Applications:</b>
Bond	■ ■ ■ ■ □ □ □ □	Stone/Concrete	●
Aggression	■ ■ ■ ■ □ □ □ □	Castings	ⓘ
Service life	■ ■ ■ □ □ □ □ □		

**Advantages:** For use on surfaces and edges - Ideal for stone and mineral materials due to sharp, coarse SiC grain

Diameter x Height x Bore in mm	Form	Max. operating speed	Max. RPM	Packing unit/pcs.	Cat. number
110 x 55 x 22,23		50 m/s	8600 rpm	6	13726

**Please observe: Use only on angle grinders with cup grinding wheel guard!**  
Please see Applications Guide on page 224-233, 264-265.





# Diamond tools



Remain in full control of all processes: staying true to this motto, Klingspor managed to rise to be one of the world's first manufacturers of grinding and cutting tools. The company is now applying their extensive experience in research and development and manufacturing, their global network of distributors and their highly efficient service and logistics structure to their diamond tools.

Product	Machine	Application - Material	<b>SPECIAL</b>	<b>SUPRA</b>	<b>EXTRA</b>	Page
Diamond cutting blades Ø 100 - 230 mm	Angle grinder	Universal	<i>DT 900 U</i> <i>DT 900 UD</i> <i>DT 900 UT</i>	<i>DT 600 U</i> <i>DT 612 UT</i>	<i>DT 300 U</i> <i>DT 350 U</i> <i>DT 300 UT</i> <i>DT 310 UT</i> <i>DT 500 AC</i>	280-284
		Concrete	<i>DT 900 B</i>			285
		Clinker	<i>DT 900 K</i>			285
		Lime sandstone, screed and abrasive materials		<i>DT 600 AS</i>		286
		Granite	<i>DT 900 G</i>	<i>DT 600 G</i> <i>DT 600 GU</i>		286-287
		Tiles	<i>DT 900 FL</i> <i>DT 900 FT</i> <i>DT 900 FP</i>	<i>DT 600 F</i>	<i>DT 300 F</i>	288-290
		Mortar rake		<i>DN 600 U</i>		290
		Cup grinding wheels	Angle grinder	Concrete		<i>DS 600 B</i> <i>DS 600 S</i>
Lime sandstone, screed and abrasive materials				<i>DS 600 A</i>		292
Granite				<i>DS 600 GC</i> <i>DS 600 GM</i> <i>DS 600 GF</i>		293-294
Adapter M14					<i>DZ 114</i>	294
Diamond cutting blades Ø 250 - 500 mm	Petrol powered cutter, Table saw, Joint cutter			Universal	<i>DT 900 U</i> <i>DT 900 US</i>	<i>DT 600 U</i> <i>DT 612 UT</i>
		Tiles	<i>DT 900 FL</i>	<i>DT 600 F</i>	<i>DT 300 F</i>	299-300
		Clinker	<i>DT 900 K</i>			301
		Refractory brick	<i>DT 900 R</i>			301
		Asphalt	<i>DT 902 A</i> <i>DT 910 A</i>	<i>DT 602 A</i> <i>DT 612 A</i>	<i>DT 350 A</i>	302-304
		Asphalt / concrete		<i>DT 612 AB</i>	<i>DT 350 AB</i>	305
		Green concrete	<i>DT 910 BF</i>			306
		Concrete	<i>DT 900 B</i> <i>DT 902 B</i> <i>DT 910 B</i>	<i>DT 602 B</i>		306-308
		Reduction rings			<i>DZ 100 RR</i>	308
		Drill bits	Drill stand	Concrete	<i>DR 912 B</i>	<i>DK 612 B</i> <i>DK 654 B</i>
Individual segments, ring segments	<i>DO 900 B</i>			<i>DE 600 B</i>		312
Percussion drill	Concrete			<i>DD 600 U</i>		313
	Adapter kit				<i>ADS 200</i>	313
Drilling machine	Tiles			<i>DB 600 F</i>		314
Angle grinder	Tiles			<i>DK 600 F</i>		315, 316
	Hole starting aid			<i>ABH 80</i>	316	



# Diamond tools

Applications guide

## The three product lines

The right tool for every application: Klingspor diamond tools are available in three product lines that are colour-coded to provide the user with a quick overview of the most important materials for which the tools are suitable.



### **SPECIAL**

**Product line 900** – High performance tools offering outstanding cutting performance and service life. For users who need their tools to perform at peak output and reliability even if subjected to the most punishing applications.



### **SUPRA**

**Product line 600** – Professional tools with an exceptional price-performance ratio. For users who require diamond tools that deliver reliable and powerful performance every day.



### **EXTRA**

**Product line 300** – Brand name quality at an affordable price. For users who expect their tools to meet professional standards, but do not need to use them continuously.

# Diamond tools

Applications guide



1. Klingspor cat. number
2. Product group / type
3. Applications
4. Safety pictograms
5. Max. operating speed
6. Klingspor logo



7. Information about the manufacturer
8. Safety standard
9. Dimensions in mm and inches
10. Max. RPM
11. Rotational direction

## Colour coding system of the Klingspor® diamond tools



**Asphalt**

Black



**Tiles**

Green



**Stone/Fireproof**

Blue



**Concrete**

Red

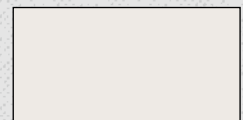

**Universal**

White

# Diamond tools

## Applications guide



1.

### Standard gullet

- ▶ rapid feed rate
- ▶ exceptional cutting properties



2.

### Turbo continuous rim

- ▶ exceptionally smooth operation
- ▶ clean cutting edges



3.

### Continuous rim

- ▶ clean cutting edges
- ▶ work with superior precision
- ▶ short cutting times



4.

### Turbo segments

- ▶ exceptionally smooth operation
- ▶ clean cutting edges
- ▶ fast cutting speed
- ▶ long service life



5.

### Short segments

- ▶ first-rate cutting performance
- ▶ clean cutting edges



6.

### Wide gullet

- ▶ high feed rate

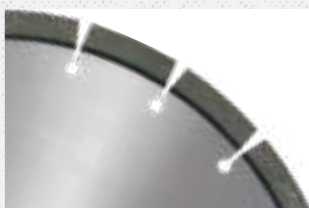

7.

### Narrow gullet

- ▶ clean cut
- ▶ exceptionally smooth operation thanks to narrow segment spacings



8.

### Hammer segments

- ▶ prevent rear grinding
- ▶ prevent segments tearing off
- ▶ optimal protection thanks to segments soldered in



9.

### Continuous rim with special geometry

- ▶ for extra clean cutting edges
- ▶ soft and comfortable cutting performance



10.

### Continuous rim with laser-cut slots

- ▶ for fine and clean cutting edges
- ▶ specially designed for ceramic and fine stoneware

## Number of revolutions

Diamond tools made by Klingspor are high performance products and have been engineered to reach their highest level of performance at a level immediately below their maximum peripheral surface speeds. The maximum permissible values for motor speed and operating speed are indicated on every diamond blade. The table

below contains all permissible maximum speeds as a function of the diameter and the maximum permissible operating speed of the diamond tools.

		Maximum operating speed [m/s]									
		30	35	40	45	50	55	60	70	80	100
Ø [mm]	200	2865	3342	3820	4297	4775	5252	5730	6685	7640	
	230	2491	2906	3322	3737	4152	4567	4982	5813	6643	
	250	2292	2674	3056	3438	3820	4202	4584	5348	6112	
	300	1910	2228	2547	2865	3183	3502	3820	4456	5093	6360
	350	1637	1910	2183	2456	2728	3001	3274	3820	4366	5450
	400	1432	1671	1910	2149	2387	2626	2865	3342	3820	4770
	450	1273	1485	1698	1910	2122	2334	2547	2971	3395	4240
	500	1146	1337	1528	1719	1910	2101	2292	2674	3056	3810
	550	1042	1215	1389	1563	1736	1910	2084	2431	2778	
	600	955	1114	1273	1432	1592	1751	1910	2228	2547	

## Motor speeds and cooling water quantity

### The recommended speed range

The chart illustrates the ideal speed range for drill bits as a function of the diameter and the maximum permissible operating speed.

### Recommended cooling water quantity

Drill bits require cooling with water regardless of the material on which they are used. Refer to the right side of the table for the recommended quantity of cooling water.

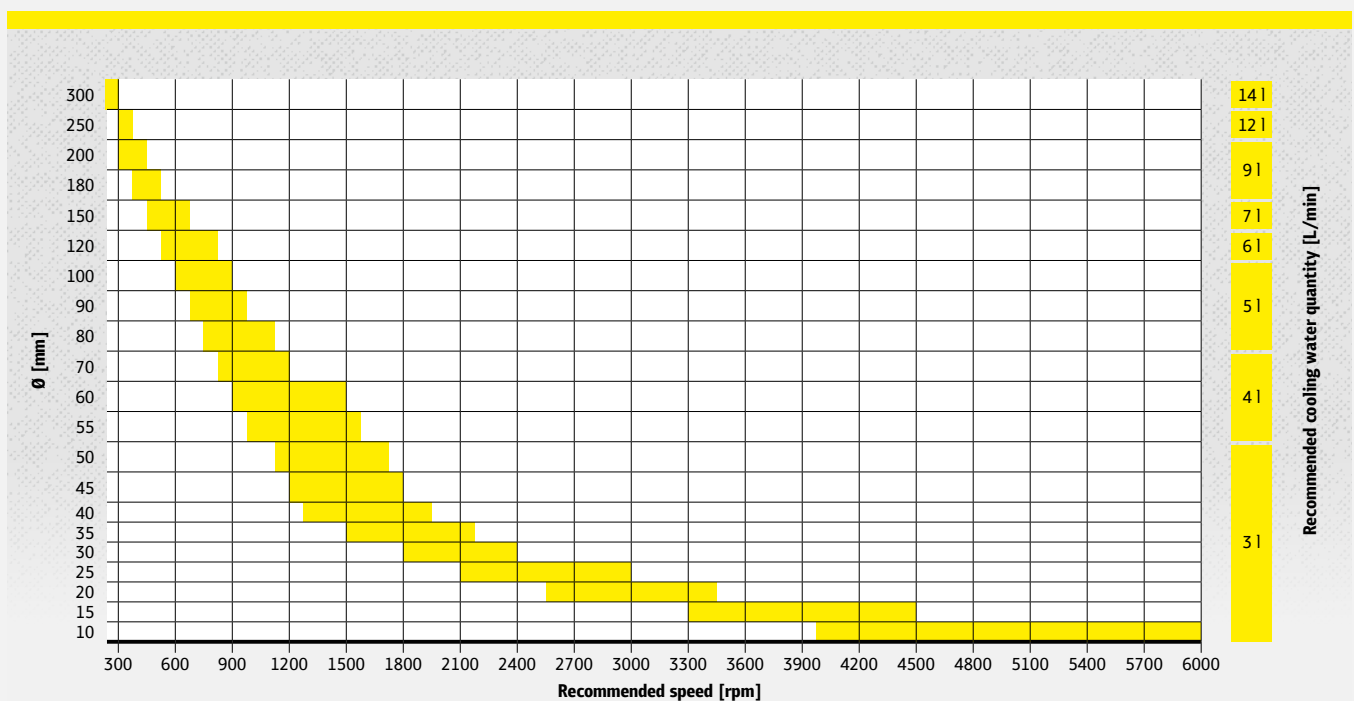



# Diamond cutting blades for angle grinders

Universal

Diamond cutting blade

## DT 300 U EXTRA

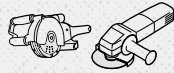

### Properties

Design	Sintered
Segmentation	Standard
Aggression	■ ■ ■ ■ □ □ □ □
Service life	■ ■ ■ □ □ □ □ □

### Applications:

Construction materials	●
Concrete, universal	●

**Advantages:** Product for universal use on general construction material - Excellent cutting performance - Great price-performance ratio

Diameter x Bore in mm	Max. operating speed	Max. RPM	Segment in mm Number / Length / Width / Height	Packing unit/pcs.	Cat. number
115 x 22,23	80 m/s	13300 rpm	8 / 37,3 / 1,6 / 7	1	325345
125 x 22,23	80 m/s	12200 rpm	9 / 36,4 / 1,6 / 7	1	325346
180 x 22,23	80 m/s	8500 rpm	13 / 38,1 / 2 / 7	1	325347
230 x 22,23	80 m/s	6600 rpm	16 / 40,2 / 2,3 / 7	1	325348

Universal

Diamond cutting blade

## DT 350 U EXTRA



### Properties

Design	Laser welded
Segmentation	Standard
Aggression	■ ■ ■ ■ ■ □ □ □
Service life	■ ■ ■ ■ ■ □ □ □

### Applications:

Construction materials	●
Concrete, universal	●

**Advantages:** Product with laser-welded standard segments for universal use on general construction material - Smooth, fast and low-vibration cutting with unmatched service life - Optimum price-performance ratio

Diameter x Bore in mm	Max. operating speed	Max. RPM	Segment in mm Number / Length / Width / Height	Packing unit/pcs.	Cat. number
115 x 22,23	80 m/s	13300 rpm	8 / 33 / 2,4 / 10	1	336214
125 x 22,23	80 m/s	12200 rpm	9 / 33 / 2,4 / 10	1	336215
180 x 22,23	80 m/s	8500 rpm	11 / 42 / 2,6 / 10	1	336216
230 x 22,23	80 m/s	6600 rpm	15 / 42 / 2,6 / 10	1	336219

Please observe: Please see Applications Guide on page 274-278.

# Diamond cutting blades for angle grinders



Universal

Diamond cutting blade

## DT 600 U SUPRA



### Properties

Design	Laser welded
Segmentation	Short segments
Aggression	■ ■ ■ ■ ■ □ □
Service life	■ ■ ■ ■ ■ □ □



### Applications:

Construction materials	●
Concrete, universal	●
Cured concrete, reinforced	●
Chalky sandstone	●



• Short segments

**Advantages:** Suitable for a various range of applications - First-rate cutting performance - Exceptional service life thanks to the use of premium grade raw materials and diamonds - Clean cutting edges

Diameter x Bore in mm	Max. operating speed	Max. RPM	Segment in mm Number / Length / Width / Height	Packing unit/pcs.	Cat. number
100 x 16	80 m/s	15300 rpm	11 / 20 / 2,4 / 9	1	325025
115 x 22,23	80 m/s	13300 rpm	13 / 20 / 2,4 / 9	1	322630
125 x 22,23	80 m/s	12200 rpm	15 / 20 / 2,4 / 9	1	322631
140 x 22,23	80 m/s	11000 rpm	17 / 20 / 2,4 / 9	1	325046
150 x 22,23	80 m/s	10200 rpm	18 / 20 / 2,4 / 9	1	322632
180 x 22,23	80 m/s	8500 rpm	22 / 20 / 2,6 / 9	1	322633
230 x 22,23	80 m/s	6600 rpm	30 / 20 / 2,6 / 9	1	322634

Universal

Diamond cutting blade

## DT 612 UT SUPRA



### Properties

Design	Laser welded
Segmentation	Turbo
Aggression	■ ■ ■ ■ ■ □ □
Service life	■ ■ ■ ■ ■ □ □



### Applications:

Construction materials	●
Concrete, universal	●
Cured concrete, reinforced	●
Chalky sandstone	●



• Turbo segments  
• 12 mm high segments

**Advantages:** Special turbo segments for an extremely high cutting speed on almost all hard materials - Excellent service life even on reinforced concrete

Diameter x Bore in mm	Max. operating speed	Max. RPM	Segment in mm Number / Length / Width / Height	Packing unit/pcs.	Cat. number
115 x 22,23	80 m/s	13300 rpm	8 / 33 / 2,4 / 12	1	334044
125 x 22,23	80 m/s	12200 rpm	9 / 33 / 2,4 / 12	1	334045
180 x 22,23	80 m/s	8500 rpm	11 / 42 / 2,6 / 12	1	334046
230 x 22,23	80 m/s	6600 rpm	15 / 42 / 2,6 / 12	1	334047

Please observe: Please see Applications Guide on page 274-278.

Diamond tools



# Diamond cutting blades for angle grinders

Universal

Diamond cutting blade

## DT 900 U SPECIAL



### Properties

Design	Laser welded
Segmentation	Turbo
Aggression	■■■■■■■■■■
Service life	■■■■■■■■■■



### Applications:

Construction materials	●
Concrete, universal	●
Cured concrete, reinforced	●
Chalky sandstone	●
Hard stone	○



- Turbo segments
- Titanium-coated diamonds

**Advantages:** Ultra fast cutting speed on almost any hard material thanks to specially designed turbo segments - Further increased service life thanks to titanium-coated diamonds even on reinforced concrete

Diameter x Bore in mm	Max. operating speed	Max. RPM	Segment in mm Number / Length / Width / Height	Packing unit/pcs.	Cat. number
115 x 22,23	80 m/s	13300 rpm	8 / 33 / 2,4 / 12	1	325206
125 x 22,23	80 m/s	12200 rpm	9 / 33 / 2,4 / 12	1	325209
180 x 22,23	80 m/s	8500 rpm	11 / 42 / 2,6 / 12	1	325028
230 x 22,23	80 m/s	6600 rpm	15 / 42 / 2,6 / 12	1	325045

Universal

Diamond cutting blade

## DT 900 UD SPECIAL



### Properties

Design	Laser welded
Segmentation	Turbo
Aggression	■■■■■■■■■■
Service life	■■■■■■■■■■



### Applications:

Cured concrete, reinforced	●
Concrete, universal	●
Construction materials	●
Chalky sandstone	●
Hard stone	○



- Turbo segments
- Titanium-coated diamonds
- Detenso core

**Advantages:** Ultra fast cutting speed thanks to specially designed turbo segments - Low vibration detenso core for efficient noise reduction - Extended service life thanks to titanium-coated diamonds, suitable for use on almost any hard material

Diameter x Bore in mm	Max. operating speed	Max. RPM	Segment in mm Number / Length / Width / Height	Packing unit/pcs.	Cat. number
230 x 22,23	80 m/s	6600 rpm	15 / 42 / 2,6 / 12	1	325210

Please observe: Please see Applications Guide on page 274-278.

Universal

Diamond cutting blade

## DT 300 UT EXTRA



### Properties

Design	Sintered
Segmentation	Turbo continuous rim
Aggression	■ ■ ■ ■ □ □ □ □
Service life	■ ■ ■ □ □ □ □ □



### Applications:

Construction materials	●
Concrete, universal	●
Roof tiles	●

**Advantages:** Suitable for a various range of applications - Excellent cutting performance - Great price-performance ratio - Turbo segments for clean and nick-free edges - Ideal for roofers

Diameter x Bore in mm	Max. operating speed	Max. RPM	Segment in mm Number / Length / Width / Height	Packing unit/pcs.	Cat. number
100 x 16 / 22,23	80 m/s	15300 rpm	CR / CR / 1,9 / 7	1	330625
115 x 22,23	80 m/s	13300 rpm	CR / CR / 1,9 / 7	1	325353
125 x 22,23	80 m/s	12200 rpm	CR / CR / 1,9 / 7	1	325354
180 x 22,23	80 m/s	8500 rpm	CR / CR / 2,2 / 7	1	325355
230 x 22,23	80 m/s	6600 rpm	CR / CR / 2,5 / 7	1	325356

Universal

Diamond cutting blade

## DT 310 UT EXTRA



### Properties

Design	Sintered
Segmentation	Turbo continuous rim
Aggression	■ ■ ■ ■ □ □ □ □
Service life	■ ■ ■ □ □ □ □ □



### Applications:

Construction materials	●
Concrete, universal	●
Roof tiles	●



• 10 mm high segments

**Advantages:** All-purpose - Excellent cutting performance, great price-performance ratio - Turbo segments for clean and nick-free edges - Ideal for roofers - For cutting clay and roof tiles

Diameter x Bore in mm	Max. operating speed	Max. RPM	Segment in mm Number / Length / Width / Height	Packing unit/pcs.	Cat. number
100 x 16 / 22,23	80 m/s	15300 rpm	CR / CR / 2 / 10	1	334087
115 x 22,23	80 m/s	13300 rpm	CR / CR / 2 / 10	1	334088
125 x 22,23	80 m/s	12200 rpm	CR / CR / 2 / 10	1	334089
180 x 22,23	80 m/s	8500 rpm	CR / CR / 2,5 / 10	1	334090
230 x 22,23	80 m/s	6600 rpm	CR / CR / 2,5 / 10	1	334091

Please observe: Please see Applications Guide on page 274-278.

# Diamond cutting blades for angle grinders

Universal

Diamond cutting blade

## DT 500 AC ACCU



### Properties

Design	Sintered
Segmentation	Turbo continuous rim
Aggression	■ ■ ■ ■ ■ □ □
Service life	■ ■ ■ ■ □ □ □



### Applications:

Construction materials	●
Concrete, universal	●

ACCU

**Advantages:** All-rounder with turbo segments for clean and nick-free edges - Optimized cutting performance for all battery-powered angle grinders

Diameter x Bore in mm	Max. operating speed	Max. RPM	Segment in mm Number / Length / Width / Height	Packing unit/pcs.	Cat. number
115 x 22,23	80 m/s	13300 rpm	CR / CR / 1,9 / 7	1	331229
125 x 22,23	80 m/s	12200 rpm	CR / CR / 1,9 / 7	1	331230

Universal

Diamond cutting blade

## DT 900 UT SPECIAL



### Properties

Design	Sintered
Segmentation	Turbo continuous rim
Aggression	■ ■ ■ ■ ■ □ □
Service life	■ ■ ■ ■ □ □ □



### Applications:

Concrete, universal	●
Construction materials	●
Roof tiles	●



• Wave-shaped core

**Advantages:** Wave-shaped steel core - Use on construction material - Clean cutting edges - High aggressiveness

Diameter x Bore in mm	Max. operating speed	Max. RPM	Segment in mm Number / Length / Width / Height	Packing unit/pcs.	Cat. number
100 x 16 / 22,23	80 m/s	15300 rpm	CR / CR / 2,2 / 10	1	330626
115 x 22,23	80 m/s	13300 rpm	CR / CR / 2,2 / 10	1	325364
125 x 22,23	80 m/s	12200 rpm	CR / CR / 2,2 / 10	1	325365
180 x 22,23	80 m/s	8500 rpm	CR / CR / 2,5 / 10	1	325366
230 x 22,23	80 m/s	6600 rpm	CR / CR / 2,5 / 10	1	325367

Please observe: Please see Applications Guide on page 274-278.

Concrete

Diamond cutting blade

## DT 900 B SPECIAL



### Properties

Design	Laser welded
Segmentation	Standard
Aggression	■■■■■■■■■
Service life	■■■■■■■■■



### Applications:

Cured concrete, reinforced	●
Concrete, universal	●
Chalky sandstone	⓪
Construction materials	⓪



• Titanium-coated diamonds

**Advantages:** Titanium-coated diamonds for first-rate cutting performance - Fast cutting speed even on reinforced concrete - Unrivalled service life - Designed for professional applications on concrete

Diameter x Bore in mm	Max. operating speed	Max. RPM	Segment in mm Number / Length / Width / Height	Packing unit/pcs.	Cat. number
115 x 22,23	80 m/s	13300 rpm	8 / 33 / 2,4 / 12	1	325205
125 x 22,23	80 m/s	12200 rpm	9 / 33 / 2,4 / 12	1	325208
180 x 22,23	80 m/s	8500 rpm	11 / 42 / 2,6 / 12	1	325027
230 x 22,23	80 m/s	6600 rpm	15 / 42 / 2,6 / 12	1	325034

Clinker

Diamond cutting blade

## DT 900 K SPECIAL



### Properties

Design	Laser welded
Segmentation	Standard
Aggression	■■■■■■■□□
Service life	■■■■■■■□□



### Applications:

Clinker	●
Concrete products	⓪
Construction materials	⓪

**Advantages:** Exceptional cutting performance - Outstanding service life and clean cutting edges - Particularly well suited for clinker of all degrees of hardness

Diameter x Bore in mm	Max. operating speed	Max. RPM	Segment in mm Number / Length / Width / Height	Packing unit/pcs.	Cat. number
115 x 22,23	80 m/s	13300 rpm	8 / 33 / 2,4 / 12	1	325204
125 x 22,23	80 m/s	12200 rpm	9 / 33 / 2,4 / 12	1	325207
180 x 22,23	80 m/s	8500 rpm	11 / 42 / 2,6 / 12	1	325026
230 x 22,23	80 m/s	6600 rpm	15 / 42 / 2,6 / 12	1	325033

Diamond tools



# Diamond cutting blades for angle grinders

Chalky sandstone

Diamond cutting blade

## DT 600 AS SUPRA



### Properties

Design	Laser welded
Segmentation	Standard
Aggression	■ ■ ■ ■ ■ □ □ □
Service life	■ ■ ■ ■ ■ ■ ■ ■



### Applications:

Chalky sandstone	●
------------------	---

**Advantages:** The use of hard segments lets the blade achieve an outstanding service life - Perfectly suited for sandstone, chalky sandstone and abrasive materials

Diameter x Bore in mm	Max. operating speed	Max. RPM	Segment in mm				Packing unit/pcs.	Cat. number
			Number	Length	Width	Height		
115 x 22,23	80 m/s	13300 rpm	8	33	2,5	12	1	334039
125 x 22,23	80 m/s	12200 rpm	9	33	2,5	12	1	334040
150 x 22,23	80 m/s	10200 rpm	11	33	2,5	12	1	336180
180 x 22,23	80 m/s	8500 rpm	11	42	2,7	12	1	334041
230 x 22,23	80 m/s	6600 rpm	15	42	2,7	12	1	334042

Granite

Diamond cutting blade

## DT 600 G SUPRA



### Properties

Design	Laser welded
Segmentation	Short segments
Aggression	■ ■ ■ ■ ■ □ □ □
Service life	■ ■ ■ ■ □ □ □ □



### Applications:

Granite	●
Terrazzo	●



• Short segments

**Advantages:** High stock removal rate - Excellent service life - Clean cutting - Great price-performance ratio - Suitable for all types of granite

Diameter x Bore in mm	Max. operating speed	Max. RPM	Segment in mm				Packing unit/pcs.	Cat. number
			Number	Length	Width	Height		
115 x 22,23	80 m/s	13300 rpm	13	20	2,4	9	1	325030
125 x 22,23	80 m/s	12200 rpm	15	20	2,4	9	1	325032
180 x 22,23	80 m/s	8500 rpm	22	20	2,6	9	1	325096
230 x 22,23	80 m/s	6600 rpm	30	20	2,6	9	1	325162

Please observe: Please see Applications Guide on page 274-278.

Granite

Diamond cutting blade

## DT 600 GU SUPRA



### Properties

Design	Laser welded
Segmentation	Standard
Aggression	■ ■ ■ ■ ■ □ □
Service life	■ ■ ■ ■ ■ □ □



### Applications:

Granite	●
Terrazzo	●

**Advantages:** High stock removal rate - Excellent service life - Clean cutting - Great price-performance ratio - Suitable for all types of granite

Diameter x Bore in mm	Max. operating speed	Max. RPM	Segment in mm Number / Length / Width / Height	Packing unit/pcs.	Cat. number
115 x 22,23	80 m/s	13300 rpm	8 / 33 / 2,4 / 10	1	336614
125 x 22,23	80 m/s	12200 rpm	9 / 33 / 2,4 / 10	1	336615
180 x 22,23	80 m/s	8500 rpm	11 / 42 / 2,6 / 10	1	336616
230 x 22,23	80 m/s	6600 rpm	15 / 42 / 2,6 / 10	1	336617

Granite

Diamond cutting blade

## DT 900 G SPECIAL



### Properties

Design	Laser welded
Segmentation	Narrow gullet
Aggression	■ ■ ■ ■ ■ ■ ■ ■
Service life	■ ■ ■ ■ ■ ■ ■ ■



### Applications:

Granite	●
Porphyry, quartzite	●
Terrazzo	●



- Conical segments
- Detenso core

**Advantages:** Outstanding cutting properties thanks to particularly narrow spacing of the tapered segments - Low vibration detenso core for efficient noise reduction - Smooth and quiet cutting with clean cutting edges - Long service life - Also the perfect choice for all types of granite including porphyry and quartzite

Diameter x Bore in mm	Max. operating speed	Max. RPM	Segment in mm Number / Length / Width / Height	Packing unit/pcs.	Cat. number
115 x 22,23	80 m/s	13300 rpm	12 / 28 / 2,5 / 12	1	325029
125 x 22,23	80 m/s	12200 rpm	13 / 28 / 2,5 / 12	1	325031
180 x 22,23	80 m/s	8500 rpm	18 / 28 / 2,8 / 12	1	325049
230 x 22,23	80 m/s	6600 rpm	24 / 28 / 2,8 / 12	1	325115



# Diamond cutting blades for angle grinders

Tiles

Diamond cutting blade

## DT 300 F EXTRA



### Properties

Design	Sintered
Segmentation	Continuous rim
Aggression	■ ■ ■ ■ □ □ □ □
Service life	■ ■ ■ ■ □ □ □ □

### Applications:

Tiles	●
Stove tiles	●

**Advantages:** Clean edges when used for cutting tiles - Attractively priced quality wheel

Diameter x Bore in mm	Max. operating speed	Max. RPM	Segment in mm Number / Length / Width / Height	Packing unit/pcs.	Cat. number
100 x 16 / 22,23	80 m/s	15300 rpm	CR / CR / 1,6 / 7	1	330623
115 x 22,23	80 m/s	13300 rpm	CR / CR / 1,6 / 7	1	325357
125 x 22,23	80 m/s	12200 rpm	CR / CR / 1,6 / 7	1	325358
180 x 22,23	80 m/s	8500 rpm	CR / CR / 1,6 / 7	1	325359
230 x 22,23	80 m/s	6600 rpm	CR / CR / 1,9 / 7	1	325360

Tiles

Diamond cutting blade

## DT 600 F SUPRA



### Properties

Design	Sintered
Segmentation	Continuous rim
Aggression	■ ■ ■ ■ ■ □ □ □ □
Service life	■ ■ ■ ■ ■ □ □ □ □

### Applications:

Stoneware	●
Stove tiles	●
Stove tiles, glazed	●

**Advantages:** Professional wheel for tiles and feldspar - For precision working - Short cutting-off times - Clean edges

Diameter x Bore in mm	Max. operating speed	Max. RPM	Segment in mm Number / Length / Width / Height	Packing unit/pcs.	Cat. number
100 x 16 / 22,23	80 m/s	15300 rpm	CR / CR / 1,6 / 7	1	330624
115 x 22,23	80 m/s	13300 rpm	CR / CR / 1,6 / 7	1	325368
125 x 22,23	80 m/s	12200 rpm	CR / CR / 1,6 / 7	1	325369
150 x 22,23	80 m/s	10200 rpm	CR / CR / 1,6 / 7	1	325370
180 x 22,23	80 m/s	8500 rpm	CR / CR / 1,6 / 7	1	325371
230 x 22,23	80 m/s	6600 rpm	CR / CR / 1,9 / 7	1	325372

Please observe: Please see Applications Guide on page 274-278.

Tiles

Diamond cutting blade

## DT 900 FL SPECIAL



### Properties

Design	Sintered
Segmentation	Continuous rim, with laser-cut slots
Aggression	■■■■■■■□
Service life	■■■■■■■□



### Applications:

Wall tiles	●
Floor tiles	●
Porcelain	●
Ceramics	●
Marble	●



• Closed edge with laser-cut slots

**Advantages:** High-precision tool for hard wall and floor tiles - Laser-cut slots for exceptionally smooth operation and perfectly cut edges

Diameter x Bore in mm	Max. operating speed	Max. RPM	Segment in mm Number / Length / Width / Height	Packing unit/pcs.	Cat. number
115 x 22,23	80 m/s	13300 rpm	CR / CR / 1,4 / 7	1	331042
125 x 22,23	80 m/s	12200 rpm	CR / CR / 1,4 / 7	1	331043
180 x 22,23	80 m/s	8500 rpm	CR / CR / 1,6 / 7	1	331044
230 x 22,23	80 m/s	6600 rpm	CR / CR / 1,8 / 7	1	331041

Tiles

Diamond cutting blade

## DT 900 FT SPECIAL



### Properties

Design	Sintered
Segmentation	Turbo continuous rim
Aggression	■■■■■■■
Service life	■■■■■■■□



### Applications:

Stoneware	●
Stove tiles	●
Stove tiles, glazed	●
Granite	●



• Thin steel core with steel core reinforcement

**Advantages:** 1.4 mm thin professional blade for extremely demanding applications - Work results of superior quality - Continuous rim with turbo segments - Clean and nick-free edges

Diameter x Bore in mm	Max. operating speed	Max. RPM	Segment in mm Number / Length / Width / Height	Packing unit/pcs.	Cat. number
100 x 16 / 22,23	80 m/s	15300 rpm	CR / CR / 1,4 / 7,5	1	330627
115 x 22,23	80 m/s	13300 rpm	CR / CR / 1,4 / 7,5	1	325392
125 x 22,23	80 m/s	12200 rpm	CR / CR / 1,4 / 7,5	1	325393
180 x 22,23	80 m/s	8500 rpm	CR / CR / 2 / 7	1	330628
230 x 22,23	80 m/s	6600 rpm	CR / CR / 2 / 7	1	330629

Please observe: Please see Applications Guide on page 274-278.

# Diamond cutting blades for angle grinders

Tiles

Diamond cutting blade

## DT 900 FP SPECIAL



### Properties

Design	Sintered
Segmentation	Continuous rim, with special geometry
Aggression	■■■■■■■■■
Service life	■■■■■■■□



### Applications:

Hard floor tiles	●
Porcelain	●
Hard wall tiles	●
Hard fine stoneware	●
Ceramics	●



- Continuous rim with special geometry
- Extra thin steel core
- With steel core reinforcement

**Advantages:** Extra thin disc for hard tiles and porcelain - The special geometry allows for superior cutting speeds and perfectly cut edges

Diameter x Bore in mm	Max. operating speed	Max. RPM	Segment in mm Number / Length / Width / Height	Packing unit/pcs.	Cat. number
115 x 22,23	80 m/s	13300 rpm	CR / CR / 1,4 / 10	1	331039
125 x 22,23	80 m/s	12200 rpm	CR / CR / 1,4 / 10	1	331040

Mortar rake

Broaching wheel

## DN 600 U SUPRA



### Properties

Design	Laser welded
Segmentation	Standard
Aggression	■■■■■■■□
Service life	■■■■■■■□



### Applications:

Mortar joints	●
Plaster	●
Aerated concrete	●



- Hammer segments

**Advantages:** Special broaching wheel with robust design for removing mortar from bricks, natural stones and clinker facades - Specially designed hammer segments - Optimum protection of the steel core

Diameter x Bore in mm	Max. operating speed	Max. RPM	Segment in mm Number / Length / Width / Height	Packing unit/pcs.	Cat. number
80 x 22,23	80 m/s	19100 rpm	6 / 30 / 6 / 7	1	330630
115 x 22,23	80 m/s	13300 rpm	9 / 32 / 6 / 7	1	330631
115 x 22,23	80 m/s	13300 rpm	9 / 32 / 8 / 7	1	330658
115 x 22,23	80 m/s	13300 rpm	9 / 32 / 10 / 7	1	330663
115 x 22,23	80 m/s	13300 rpm	9 / 33 / 4,5 / 7	1	325380
125 x 22,23	80 m/s	12200 rpm	10 / 32 / 6 / 7	1	330632
125 x 22,23	80 m/s	12200 rpm	10 / 32 / 8 / 7	1	330662
125 x 22,23	80 m/s	12200 rpm	10 / 32 / 10 / 7	1	330664
125 x 22,23	80 m/s	12200 rpm	10 / 33 / 4,5 / 7	1	325381

Please observe: Please see Applications Guide on page 274-278.

# Diamond cup grinding wheels for angle grinders



Concrete

Diamond cup grinding wheel

## DS 300 B EXTRA



### Properties

Design	Brazed
Segmentation	Standard
Aggression	■ ■ ■ ■ □ □ □ □
Service life	■ ■ ■ ■ □ □ □ □



### Applications:

Concrete	●
Screed	●
Construction materials	●

**Advantages:** Double row cup grinding wheel with outstanding stock removal performance - High aggressiveness at low force requirements - Exceptional price-performance ratio - M14 adapter available, see DZ 114

Diameter x Bore in mm	Cup grinding wheel height in mm	Max. operating speed	Max. RPM	Segment in mm Number / Width / Height	Packing unit/pcs.	Cat. number
100 x 16 / 22,23	20	80 m/s	15300 rpm	14 / 7 / 5,5	1	330622
115 x 22,23	20	80 m/s	13300 rpm	14 / 8,2 / 5,5	1	325361
125 x 22,23	24,5	80 m/s	12200 rpm	18 / 7 / 5	1	325362
180 x 22,23	30,5	80 m/s	8500 rpm	22 / 8 / 5	1	325363

Concrete

Diamond cup grinding wheel

## DS 600 B SUPRA



### Properties

Design	Brazed
Segmentation	Standard
Aggression	■ ■ ■ ■ ■ □ □ □
Service life	■ ■ ■ ■ ■ □ □ □



### Applications:

Concrete	●
Screed	●
Construction materials	●

**Advantages:** Double row cup grinding wheel for machining concrete and abrasive materials - Efficient dust extraction - Aggressive grinding performance - Long service life - M14 adapter available, see DZ 114

Diameter x Bore in mm	Cup grinding wheel height in mm	Max. operating speed	Max. RPM	Segment in mm Number / Width / Height	Packing unit/pcs.	Cat. number
100 x 16 / 22,23	20	80 m/s	15300 rpm	16 / 8,5 / 5,5	1	330621
115 x 22,23	20	80 m/s	13300 rpm	16 / 8,2 / 5,5	1	325377
125 x 22,23	23,5	80 m/s	12200 rpm	20 / 7,2 / 5,5	1	325378
180 x 22,23	30,5	80 m/s	8500 rpm	24 / 8 / 5,5	1	325379

Diamond tools

Please observe: Please see Applications Guide on page 274-278.



# Diamond cup grinding wheels for angle grinders

Concrete

Diamond cup grinding wheel

## DS 600 S SUPRA



### Properties

Design	Brazed
Segmentation	Standard
Aggression	■■■■■□□
Service life	■■■■■□□



### Applications:

Concrete	●
Firebrick	●
Natural stone	●
Masonry	●
Brickwork	●



• Special geometry

**Advantages:** Excellent dust extraction thanks to specially designed (fan-shaped) opening - Low weight thanks to lightweight steel plate - Rugged performance and operation with minimum vibrations - M14 adapter available, see DZ 114

Diameter x Bore in mm	Cup grinding wheel height in mm	Max. operating speed	Max. RPM	Segment in mm Number / Width / Height	Packing unit/pcs.	Cat. number
100 x 16 / 22,23	20,5	80 m/s	15300 rpm	16 / 7,2 / 5,5	1	331022
115 x 22,23	20,5	80 m/s	13300 rpm	16 / 7,2 / 5,5	1	331023
125 x 22,23	20,5	80 m/s	12200 rpm	16 / 7,2 / 5,5	1	331024
180 x 22,23	30,5	80 m/s	8500 rpm	24 / 7,8 / 5,5	1	331025

Abrasive

Diamond cup grinding wheel

## DS 600 A SUPRA



### Properties

Design	Brazed
Segmentation	Standard
Aggression	■■■■■□□
Service life	■■■■■□□



### Applications:

Asphalt	●	Sandstone	●
Abrasive materials	●		
Green concrete	●		
Aerated concrete	●		

**Advantages:** An ideal match with all types of abrasive materials - Outstanding grinding performance combined with a long service life - Fast and smooth grinding of surfaces thanks to double-row segments - Extended service life thanks to optimized matrix and diamonds - Simple dust extraction through openings in the steel enclosure - M14 adapter available, see DZ 114

Diameter x Bore in mm	Cup grinding wheel height in mm	Max. operating speed	Max. RPM	Segment in mm Number / Width / Height	Packing unit/pcs.	Cat. number
100 x 16 / 22,23	20	80 m/s	15300 rpm	14 / 8,2 / 5,5	1	331026
115 x 22,23	20	80 m/s	13300 rpm	14 / 8,2 / 5,5	1	331027
125 x 22,23	24,5	80 m/s	12200 rpm	18 / 7,2 / 5	1	331028
180 x 22,23	30,5	80 m/s	8500 rpm	22 / 7,8 / 5,3	1	331029

Please observe: Please see Applications Guide on page 274-278.

# Diamond cup grinding wheels for angle grinders



Granite

Diamond cup grinding wheel

## DS 600 GC SUPRA



### Properties

Design	Brazed
Segmentation	Turbo
Aggression	■ ■ ■ ■ ■ ■ ■ ■
Service life	■ ■ ■ ■ ■ ■ ■ □

### Applications:

Granite	●
Hard stone	●
Marble	○

**Advantages:** Turbo-serrated diamond cup grinding wheel for granite - Premium quality for perfect grinding on hard granite - Clean grinding results on edges - Three degrees of hardness for fine, medium and coarse finish - M14 adapter available, see DZ 114

Diameter x Bore in mm	Max. operating speed	Max. RPM	Segment in mm Number / Length / Width / Height	Packing unit/pcs.	Cat. number
100 x 16 / 22,23	80 m/s	15300 rpm	Turbo / Coarse / 20 / 7,3	1	331051
115 x 22,23	80 m/s	13300 rpm	Turbo / Coarse / 20 / 7,3	1	331052
125 x 22,23	80 m/s	12200 rpm	Turbo / Coarse / 20 / 7,3	1	331053

Granite

Diamond cup grinding wheel

## DS 600 GM SUPRA

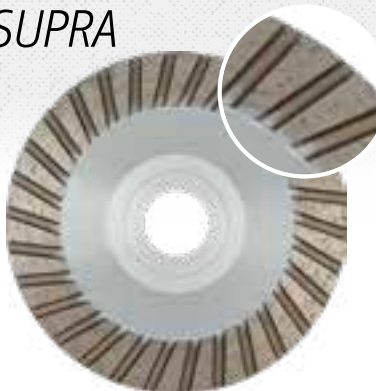

### Properties

Design	Brazed
Segmentation	Turbo
Aggression	■ ■ ■ ■ ■ ■ □ □
Service life	■ ■ ■ ■ ■ ■ □

### Applications:

Granite	●
Hard stone	●
Marble	○

**Advantages:** Turbo-serrated diamond cup grinding wheel for granite - Premium quality for perfect grinding on hard granite - Clean grinding results on edges - Three degrees of hardness for fine, medium and coarse finish - M14 adapter available, see DZ 114

Diameter x Bore in mm	Max. operating speed	Max. RPM	Segment in mm Number / Length / Width / Height	Packing unit/pcs.	Cat. number
100 x 16 / 22,23	80 m/s	15300 rpm	Turbo / Medium / 20 / 7,3	1	331054
115 x 22,23	80 m/s	13300 rpm	Turbo / Medium / 20 / 7,3	1	331055
125 x 22,23	80 m/s	12200 rpm	Turbo / Medium / 20 / 7,3	1	331056

Diamond tools

Please observe: Please see Applications Guide on page 274-278.



# Diamond cup grinding wheels for angle grinders

Granite

Diamond cup grinding wheel

## DS 600 GF SUPRA



### Properties

Design	Brazed
Segmentation	Turbo
Aggression	■ ■ ■ ■ □ □ □ □
Service life	■ ■ ■ ■ ■ ■ ■ □



### Applications:

Granite	●
Hard stone	●
Marble	○

**Advantages:** Turbo-serrated cup grinding wheel for granite - Premium quality for perfect grinding on hard granite - Clean grinding results on edges - Three degrees of hardness for fine, medium and coarse finish - M14 adapter available, see DZ 114

Diameter x Bore in mm	Max. operating speed	Max. RPM	Segment in mm Number / Length / Width / Height	Packing unit/pcs.	Cat. number
100 x 22,23	80 m/s	15300 rpm	Turbo / Fine / 20 / 7,3	1	331057
115 x 22,23	80 m/s	13300 rpm	Turbo / Fine / 20 / 7,3	1	331058
125 x 22,23	80 m/s	12200 rpm	Turbo / Fine / 20 / 7,3	1	331059

Adapter M14

## DZ 114



**Advantages:** For retooling diamond cup grinding wheels with a Ø 22.23 mm hole to an M14 spindle size - Suitable for all Klingspor diamond cup grinding wheels

Mounting	Packing unit/pcs.	Cat. number
thread M14	1	331332

Please observe: Please see Applications Guide on page 274-278.



Universal

Diamond cutting blade

## DT 300 U EXTRA

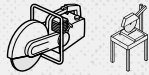

### Properties

Design	Sintered
Segmentation	Standard
Aggression	■ ■ ■ ■ □ □ □ □
Service life	■ ■ ■ ■ □ □ □ □

### Applications:

Construction materials ●

**Advantages:** Product for universal use on general construction material - Excellent cutting performance - Great price-performance ratio

Diameter x Bore in mm	Max. operating speed	Max. RPM	Segment in mm Number / Length / Width / Height	Packing unit/pcs.	Cat. number
300 x 20	100 m/s	6400 rpm	17 / 50,1 / 2,8 / 7	1	326831
300 x 25,4	100 m/s	6400 rpm	17 / 50,1 / 2,8 / 7	1	325349
300 x 30	100 m/s	6400 rpm	17 / 50,1 / 2,8 / 7	1	325351
350 x 25,4	100 m/s	5500 rpm	20 / 50,1 / 2,8 / 7	1	325350
350 x 30	100 m/s	5500 rpm	20 / 50,1 / 2,8 / 7	1	325352

Universal

Diamond cutting blade

## DT 310 UT EXTRA

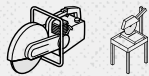

• 10 mm high segments

### Properties

Design	Sintered
Segmentation	Turbo continuous rim
Aggression	■ ■ ■ ■ □ □ □ □
Service life	■ ■ ■ ■ □ □ □ □

### Applications:

Construction materials ●  
Concrete, universal ●

**Advantages:** All-purpose - Excellent cutting performance, great price-performance ratio - Turbo segments for clean and nick-free edges

Diameter x Bore in mm	Max. operating speed	Max. RPM	Segment in mm Number / Length / Width / Height	Packing unit/pcs.	Cat. number
300 x 20	100 m/s	6400 rpm	CR / CR / 3 / 10	1	334092
300 x 25,4	100 m/s	6400 rpm	CR / CR / 3 / 10	1	339121
350 x 20	100 m/s	5500 rpm	CR / CR / 3 / 10	1	334093
350 x 25,4	100 m/s	5500 rpm	CR / CR / 3 / 10	1	339123

Please observe: Please see Applications Guide on page 274-278.

Diamond tools

# Diamond cutting blades for petrol powered cutters, table saws and joint cutters

Universal

Diamond cutting blade

## DT 350 U EXTRA



### Properties

Design	Laser welded
Segmentation	Standard
Aggression	■■■■■□□
Service life	■■■■■□□

### Applications:

Construction materials	●
Concrete, universal	●

**Advantages:** Product with laser-welded standard segments for universal use on general construction materials - Smooth, fast and low-vibration cutting with unmatched service life - Optimum price-performance ratio

Diameter x Bore in mm	Max. operating speed	Max. RPM	Segment in mm Number / Length / Width / Height	Packing unit/pcs.	Cat. number
300 x 20	100 m/s	6400 rpm	21 / 40 / 2,8 / 10	1	336223
300 x 25,4	100 m/s	6400 rpm	21 / 40 / 2,8 / 10	1	336220
350 x 20	100 m/s	5500 rpm	24 / 40 / 3 / 10	1	336224
350 x 25,4	100 m/s	5500 rpm	24 / 40 / 3 / 10	1	336221
400 x 25,4	100 m/s	4800 rpm	28 / 40 / 3,2 / 10	1	336222

Universal

Diamond cutting blade

## DT 600 U SUPRA

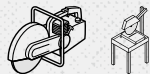
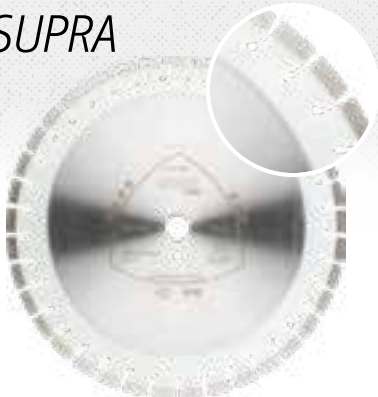

• Short segments

### Properties

Design	Laser welded
Segmentation	Short segments
Aggression	■■■■■□□
Service life	■■■■■□□

### Applications:

Construction materials	●
Concrete, universal	●
Cured concrete, reinforced	●
Chalky sandstone	●

**Advantages:** High cutting performance - Long service life thanks to the use of premium-grade raw materials and diamonds - Clean cutting edges - Effortless cutting thanks to short serrated segments

Diameter x Bore in mm	Max. operating speed	Max. RPM	Segment in mm Number / Length / Width / Height	Packing unit/pcs.	Cat. number
300 x 20	100 m/s	6400 rpm	32 / 24 / 2,8 / 10	1	325183
300 x 25,4	100 m/s	6400 rpm	32 / 24 / 2,8 / 10	1	325184
300 x 30	100 m/s	6400 rpm	32 / 24 / 2,8 / 10	1	325185
350 x 20	100 m/s	5500 rpm	37 / 24 / 3 / 10	1	325194
350 x 25,4	100 m/s	5500 rpm	37 / 24 / 3 / 10	1	325195
350 x 30	100 m/s	5500 rpm	37 / 24 / 3 / 10	1	325196
400 x 20	100 m/s	4800 rpm	43 / 24 / 3,2 / 10	1	325197
400 x 25,4	100 m/s	4800 rpm	43 / 24 / 3,2 / 10	1	325198
400 x 30	100 m/s	4800 rpm	43 / 24 / 3,2 / 10	1	325199

Continuation →

Please observe: Please see Applications Guide on page 274-278.

# Diamond cutting blades for petrol powered cutters, table saws and joint cutters



→ Continuation of DT 600 U SUPRA, Diamond cutting blade

Diameter x Bore in mm	Max. operating speed	Max. RPM	Segment in mm Number / Length / Width / Height	Packing unit/pcs.	Cat. number
450 x 25,4	100 m/s	4300 rpm	48 / 24 / 3,6 / 10	1	325201
450 x 30	100 m/s	4300 rpm	48 / 24 / 3,6 / 10	1	325200
500 x 25,4	100 m/s	3900 rpm	54 / 24 / 3,6 / 10	1	325203
500 x 30	100 m/s	3900 rpm	54 / 24 / 3,6 / 10	1	325202

Universal

Diamond cutting blade

## DT 612 UT SUPRA

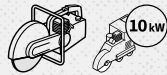

### Properties

Design	Laser welded
Segmentation	Turbo
Aggression	■■■■■■■□
Service life	■■■■■■■□

### Applications:

Concrete, universal	●
Cured concrete, reinforced	●
Construction materials	●



- Turbo segments
- 12 mm high segments

**NEW**

**Advantages:** Special turbo segments for an extremely high cutting speed on almost all hard materials - Excellent service life even on reinforced concrete

Diameter x Bore in mm	Max. operating speed	Max. RPM	Segment in mm Number / Length / Width / Height	Packing unit/pcs.	Cat. number
300 x 20	100 m/s	6400 rpm	20 / 40 / 2,8 / 12	1	340224
300 x 25,4	100 m/s	6400 rpm	20 / 40 / 2,8 / 12	1	340229
350 x 20	100 m/s	5500 rpm	22 / 40 / 3 / 12	1	340227
350 x 25,4	100 m/s	5500 rpm	22 / 40 / 3 / 12	1	340230
400 x 20	100 m/s	4800 rpm	26 / 40 / 3,2 / 12	1	340228
400 x 25,4	100 m/s	4800 rpm	26 / 40 / 3,2 / 12	1	340231

Please observe: Please see Applications Guide on page 274-278.

Diamond tools

# Diamond cutting blades for petrol powered cutters and table saws

Universal

Diamond cutting blade

## DT 900 U SPECIAL

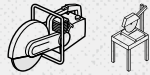

### Properties

Design	Laser welded
Segmentation	Narrow/wide gullet
Aggression	■■■■■■■■
Service life	■■■■■■■■

### Applications:

Construction materials	●	Granite	●
Concrete, universal	●		
Cured concrete, reinforced	●		
Chalky sandstone	●		

**Advantages:** Suitable for a wide range of applications - Ultra fast cutting speed - Special segment bond for long service life and clean cuts - Engineered for professional use

Diameter x Bore in mm	Max. operating speed	Max. RPM	Segmentation	Segment in mm Number / Length / Width / Height	Packing unit/pcs.	Cat. number
300 x 25,4	100 m/s	6400 rpm		18 / 40 / 2,8 / 10	1	325053
300 x 25,4	100 m/s	6400 rpm		21 / 40 / 2,8 / 10	1	325067
300 x 30	100 m/s	6400 rpm		18 / 40 / 2,8 / 10	1	325052
300 x 30	100 m/s	6400 rpm		21 / 40 / 2,8 / 10	1	325066
350 x 25,4	100 m/s	5500 rpm		21 / 40 / 3 / 10	1	325085
350 x 25,4	100 m/s	5500 rpm		24 / 40 / 3 / 10	1	325100
350 x 30	100 m/s	5500 rpm		21 / 40 / 3 / 10	1	325084
350 x 30	100 m/s	5500 rpm		24 / 40 / 3 / 10	1	325099
400 x 25,4	100 m/s	4800 rpm		24 / 40 / 3,2 / 10	1	325117
400 x 25,4	100 m/s	4800 rpm		28 / 40 / 3,2 / 10	1	325141
400 x 30	100 m/s	4800 rpm		24 / 40 / 3,2 / 10	1	325116
400 x 30	100 m/s	4800 rpm		28 / 40 / 3,2 / 10	1	325140
450 x 25,4	100 m/s	4300 rpm		26 / 40 / 3,6 / 10	1	325133
450 x 25,4	100 m/s	4300 rpm		32 / 40 / 3,6 / 10	1	325176
450 x 30	100 m/s	4300 rpm		26 / 40 / 3,6 / 10	1	325132
450 x 30	100 m/s	4300 rpm		32 / 40 / 3,6 / 10	1	325175
500 x 25,4	100 m/s	3900 rpm		36 / 40 / 3,7 / 10	1	325155
500 x 25,4	100 m/s	3900 rpm		30 / 40 / 3,7 / 10	1	325164
500 x 30	100 m/s	3900 rpm		36 / 40 / 3,7 / 10	1	325154
500 x 30	100 m/s	3900 rpm		30 / 40 / 3,7 / 10	1	325163

Please observe: Please see Applications Guide on page 274-278.



Universal

Diamond cutting blade

## DT 900 US SPECIAL



### Properties

Design	Laser welded
Segmentation	Narrow gullet
Aggression	■■■■■■■■
Service life	■■■■■■■■



### Applications:

Cured concrete, reinforced	●
Concrete, universal	●
Construction materials	●
Chalky sandstone	●
Granite	●



• Low-noise sandwich core

**Advantages:** All-purpose high-performance tool - Extremely high cutting speed - Special segment bond for long service life and clean cuts - Engineered for professional use - Ideally suited for low-noise work environments thanks to sandwich core

Diameter x Bore in mm	Max. operating speed	Max. RPM	Segmentation	Segment in mm Number / Length / Width / Height	Packing unit/pcs.	Cat. number
300 x 25,4	100 m/s	6400 rpm		21 / 40 / 2,8 / 10	1	334062
350 x 25,4	100 m/s	5500 rpm		24 / 40 / 3 / 10	1	334063
400 x 25,4	100 m/s	4800 rpm		28 / 40 / 3,2 / 10	1	334064
450 x 25,4	100 m/s	4300 rpm		32 / 40 / 3,6 / 10	1	334065
500 x 25,4	100 m/s	3900 rpm		36 / 40 / 3,7 / 10	1	334066

Tiles

Diamond cutting blade

## DT 300 F EXTRA



### Properties

Design	Sintered
Segmentation	Continuous rim
Aggression	■■■■□□□□
Service life	■■■■□□□□



### Applications:

Tiles	●
Stove tiles	●

**Advantages:** Standard tool for clean and nick-free edges - Good price-performance ratio - Reduction ring from 30 mm to 25,4 mm included

Diameter x Bore in mm	Max. operating speed	Max. RPM	Segment in mm Number / Length / Width / Height	Packing unit/pcs.	Cat. number
200 x 25,4 / 30	80 m/s	7600 rpm	CR / CR / 1,9 / 7	1	325454

Please observe: Please see Applications Guide on page 274-278.

Diamond tools



# Diamond cutting blades for table saws

Tiles

Diamond cutting blade

## DT 600 F SUPRA



### Properties

Design	Sintered
Segmentation	Continuous rim
Aggression	■■■■■□□
Service life	■■■■■□□

### Applications:

Stoneware	●
Stove tiles	●
Stove tiles, glazed	●

**Advantages:** Professional wheel for tiles and feldspar - Continuous rim for clean and nick-free edges - Reduction ring from 30 mm to 25,4 mm included

Diameter x Bore in mm	Max. operating speed	Max. RPM	Segment in mm Number / Length / Width / Height	Packing unit/pcs.	Cat. number
180 x 25,4 / 30	80 m/s	8500 rpm	CR / CR / 1,6 / 7	1	325455
200 x 25,4 / 30	80 m/s	7600 rpm	CR / CR / 1,9 / 7	1	325373
250 x 25,4 / 30	80 m/s	6100 rpm	CR / CR / 1,9 / 7	1	325374
300 x 25,4 / 30	100 m/s	6400 rpm	CR / CR / 2 / 7	1	325375
350 x 25,4 / 30	100 m/s	5500 rpm	CR / CR / 2 / 7	1	325376

Tiles

Diamond cutting blade

## DT 900 FL SPECIAL



• Closed edge with laser-cut slots

### Properties

Design	Sintered
Segmentation	Continuous rim, with laser-cut slots
Aggression	■■■■■□□
Service life	■■■■■□□

### Applications:

Wall tiles	●
Floor tiles	●
Porcelain	●
Ceramics	●
Marble	●

**Advantages:** High-precision tool for hard wall and floor tiles - Laser-cut slots for exceptionally smooth operation and perfectly cut edges - Reduction ring from 30 mm to 25,4 mm included

Diameter x Bore in mm	Max. operating speed	Max. RPM	Segment in mm Number / Length / Width / Height	Packing unit/pcs.	Cat. number
180 x 25,4 / 30	100 m/s	10650 rpm	CR / CR / 1,6 / 7	1	331045
200 x 25,4 / 30	100 m/s	9550 rpm	CR / CR / 1,6 / 7	1	331046
230 x 25,4 / 30	100 m/s	8350 rpm	CR / CR / 1,8 / 7	1	331048
250 x 25,4 / 30	100 m/s	7600 rpm	CR / CR / 2 / 7	1	331047
300 x 25,4 / 30	100 m/s	6400 rpm	CR / CR / 2,2 / 7	1	331049
350 x 25,4 / 30	100 m/s	5500 rpm	CR / CR / 2,2 / 7	1	331050

Please observe: Please see Applications Guide on page 274-278.

Clinker

Diamond cutting blade

## DT 900 K SPECIAL



### Properties









Design	Laser welded
Segmentation	Narrow/wide gullet
Aggression	■■■■■■■■■
Service life	■■■■■■■■□



### Applications:

Clinker	●
Concrete products	●
Construction materials	○

**Advantages:** Exceptional cutting performance - Outstanding service life - Narrow gullet for smooth cutting and clean cutting edges - Particularly well suited for clinker of all degrees of hardness

Diameter x Bore in mm	Max. operating speed	Max. RPM	Segmentation	Segment in mm Number / Length / Width / Height	Packing unit/pcs.	Cat. number
300 x 25,4	100 m/s	6400 rpm		18 / 40 / 2,8 / 10	1	325051
300 x 25,4	100 m/s	6400 rpm		21 / 40 / 2,8 / 10	1	325065
300 x 30	100 m/s	6400 rpm		18 / 40 / 2,8 / 10	1	325050
300 x 30	100 m/s	6400 rpm		21 / 40 / 2,8 / 10	1	325064
350 x 25,4	100 m/s	5500 rpm		21 / 40 / 3 / 10	1	325083
350 x 25,4	100 m/s	5500 rpm		24 / 40 / 3 / 10	1	325098
350 x 30	100 m/s	5500 rpm		21 / 40 / 3 / 10	1	325082
350 x 30	100 m/s	5500 rpm		24 / 40 / 3 / 10	1	325097

Firebrick

Diamond cutting blade

## DT 900 R SPECIAL



### Properties









Design	Laser welded
Segmentation	Narrow/wide gullet
Aggression	■■■■■■■■■
Service life	■■■■■■■■■



### Applications:

Firebrick	●
Refractory brick, universal	●

**Advantages:** High-performance blade, specially engineered for firebrick and refractory brick - Ultra fast cutting speed - Outstanding service life - Clean cut

Diameter x Bore in mm	Max. operating speed	Max. RPM	Segmentation	Segment in mm Number / Length / Width / Height	Packing unit/pcs.	Cat. number
300 x 25,4	100 m/s	6400 rpm		18 / 40 / 2,8 / 10	1	325055
300 x 25,4	100 m/s	6400 rpm		21 / 40 / 2,8 / 10	1	325069
300 x 30	100 m/s	6400 rpm		18 / 40 / 2,8 / 10	1	325054
300 x 30	100 m/s	6400 rpm		21 / 40 / 2,8 / 10	1	325068
350 x 25,4	100 m/s	5500 rpm		21 / 40 / 3 / 10	1	325087
350 x 25,4	100 m/s	5500 rpm		24 / 40 / 3 / 10	1	325102
350 x 30	100 m/s	5500 rpm		21 / 40 / 3 / 10	1	325086
350 x 30	100 m/s	5500 rpm		24 / 40 / 3 / 10	1	325101
400 x 25,4	100 m/s	4800 rpm		24 / 40 / 3,2 / 10	1	325119

Continuation →

Please observe: Please see Applications Guide on page 274-278.

# Diamond cutting blades for petrol powered cutters, table saws and joint cutters

→ Continuation of DT 900 R SPECIAL, Diamond cutting blade

Diameter x Bore in mm	Max. operating speed	Max. RPM	Segmentation	Segment in mm Number / Length / Width / Height	Packing unit/pcs.	Cat. number
400 x 25,4	100 m/s	4800 rpm		28 / 40 / 3,2 / 10	1	325143
400 x 30	100 m/s	4800 rpm		24 / 40 / 3,2 / 10	1	325118
400 x 30	100 m/s	4800 rpm		28 / 40 / 3,2 / 10	1	325142
450 x 25,4	100 m/s	4300 rpm		26 / 40 / 3,6 / 10	1	325135
450 x 25,4	100 m/s	4300 rpm		32 / 40 / 3,6 / 10	1	325178
450 x 30	100 m/s	4300 rpm		26 / 40 / 3,6 / 10	1	325134
450 x 30	100 m/s	4300 rpm		32 / 40 / 3,6 / 10	1	325177
500 x 25,4	100 m/s	3900 rpm		36 / 40 / 3,7 / 10	1	325157
500 x 25,4	100 m/s	3900 rpm		30 / 40 / 3,7 / 10	1	325166
500 x 30	100 m/s	3900 rpm		36 / 40 / 3,7 / 10	1	325156
500 x 30	100 m/s	3900 rpm		30 / 40 / 3,7 / 10	1	325165

Asphalt

Diamond cutting blade

## DT 350 A EXTRA

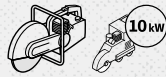

### Properties

Design	Laser welded
Segmentation	Wide gullet
Aggression	■■■■□□□□
Service life	■■■■□□□□



### Applications:

Asphalt	●
Sandstone	●



• Inclined protective segments

**NEW**

**Advantages:** Diamond cutting blade for general repairs with an outstanding price-performance ratio - Specially engineered for applications on asphalt - Inclined protective segments prevent the premature wearing of the welds which can lead to segment loss on standard blades

Diameter x Bore in mm	Max. operating speed	Max. RPM	Segmentation	Segment in mm Number / Length / Width / Height	Packing unit/pcs.	Cat. number
300 x 20	100 m/s	6400 rpm		18 / 40 / 2,8 / 10	1	337731
300 x 25,4	100 m/s	6400 rpm		18 / 40 / 2,8 / 10	1	337729
350 x 20	100 m/s	5500 rpm		21 / 40 / 3,2 / 10	1	337732
350 x 25,4	100 m/s	5500 rpm		21 / 40 / 3,2 / 10	1	337730
400 x 20	100 m/s	4800 rpm		24 / 40 / 3,4 / 10	1	337739
400 x 25,4	100 m/s	4800 rpm		24 / 40 / 3,4 / 10	1	337733
450 x 25,4	100 m/s	4300 rpm		28 / 40 / 3,7 / 10	1	337734
500 x 25,4	100 m/s	3900 rpm		30 / 40 / 3,7 / 10	1	337735

Please observe: Please see Applications Guide on page 274-278.

# Diamond cutting blades for petrol powered cutters and joint cutters



Asphalt

Diamond cutting blade

## DT 602 A SUPRA

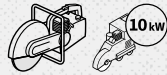

• Protective segments

### Properties

Design	Laser welded
Segmentation	Wide gullet
Aggression	■ ■ ■ ■ ■ □ □
Service life	■ ■ ■ ■ □ □ □

### Applications:

Asphalt	●
Sandstone	●

**Advantages:** First-rate cutting performance - Protective segments to guard the blade - Great price-performance ratio - Specially engineered for applications on asphalt - Also suitable for use on electric joint cutters

Diameter x Bore in mm	Max. operating speed	Max. RPM	Segmentation	Segment in mm Number / Length / Width / Height	Packing unit/pcs.	Cat. number
300 x 20	100 m/s	6400 rpm		18 / 40 / 2,8 / 10	1	327025
300 x 25,4	100 m/s	6400 rpm		18 / 40 / 2,8 / 10	1	325060
350 x 20	100 m/s	5500 rpm		21 / 40 / 3,2 / 10	1	327026
350 x 25,4	100 m/s	5500 rpm		21 / 40 / 3,2 / 10	1	325092
400 x 20	100 m/s	4800 rpm		24 / 40 / 3,4 / 10	1	327027
400 x 25,4	100 m/s	4800 rpm		24 / 40 / 3,4 / 10	1	325124
450 x 25,4	100 m/s	4300 rpm		28 / 40 / 3,7 / 10	1	325128
500 x 25,4	100 m/s	3900 rpm		30 / 40 / 3,7 / 10	1	325171

Asphalt

Diamond cutting blade

## DT 612 A SUPRA

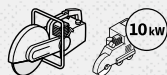

• Protective segments

### Properties

Design	Laser welded
Segmentation	Wide gullet
Aggression	■ ■ ■ ■ ■ □ □
Service life	■ ■ ■ ■ □ □ □

### Applications:

Asphalt	●
Sandstone	●

**Advantages:** High cutting speed combined with excellent service life - Protective segments to shield the core - Specially designed for applications on asphalt - Also suitable for use on electric joint cutters

Diameter x Bore in mm	Max. operating speed	Max. RPM	Segmentation	Segment in mm Number / Length / Width / Height	Packing unit/pcs.	Cat. number
300 x 25,4	100 m/s	6400 rpm		18 / 40 / 2,8 / 10	1	330075
350 x 25,4	100 m/s	5500 rpm		21 / 40 / 3,2 / 10	1	330076
400 x 25,4	100 m/s	4800 rpm		24 / 40 / 3,4 / 10	1	330077
450 x 25,4	100 m/s	4300 rpm		28 / 40 / 3,7 / 10	1	330078
500 x 25,4	100 m/s	3900 rpm		30 / 40 / 3,7 / 10	1	330079

Please observe: Please see Applications Guide on page 274-278.

Diamond tools



# Diamond cutting blades for petrol powered cutters and joint cutters

Asphalt

Diamond cutting blade

## DT 902 A SPECIAL



• Protective segments

### Properties

Design	Laser welded
Segmentation	Wide gullet
Aggression	■■■■■■■■■
Service life	■■■■■■■■□

### Applications:

Asphalt	●
Sandstone	●
Green concrete	●
Screed	●

**Advantages:** High cutting performance - 12 mm high segments - Protective segments to guard the blade

Diameter x Bore in mm	Max. operating speed	Max. RPM	Segmentation	Segment in mm Number / Length / Width / Height	Packing unit/pcs.	Cat. number
300 x 25,4	100 m/s	6400 rpm		18 / 40 / 2,8 / 12	1	325062
350 x 25,4	100 m/s	5500 rpm		21 / 40 / 3,2 / 12	1	325094
400 x 25,4	100 m/s	4800 rpm		24 / 40 / 3,4 / 12	1	325126
450 x 25,4	100 m/s	4300 rpm		28 / 40 / 3,7 / 12	1	325130
500 x 25,4	100 m/s	3900 rpm		30 / 40 / 3,7 / 12	1	325173

Asphalt

Diamond cutting blade

## DT 910 A SPECIAL



• Protective segments

### Properties

Design	Laser welded
Segmentation	Narrow gullet
Aggression	■■■■■■■■□
Service life	■■■■■■■■■

### Applications:

Asphalt	●
Sandstone	●
Green concrete	●
Screed	●

**Advantages:** Good cutting performance - 12 mm high segments - Protective segments to guard the blade - Exceptional service life

Diameter x Bore in mm	Max. operating speed	Max. RPM	Segmentation	Segment in mm Number / Length / Width / Height	Packing unit/pcs.	Cat. number
300 x 25,4	100 m/s	6400 rpm		21 / 40 / 2,8 / 12	1	325077
350 x 25,4	100 m/s	5500 rpm		24 / 40 / 3,2 / 12	1	325110
400 x 25,4	100 m/s	4800 rpm		28 / 40 / 3,4 / 12	1	325147
450 x 25,4	100 m/s	4300 rpm		30 / 40 / 3,7 / 12	1	325161
500 x 25,4	100 m/s	3900 rpm		35 / 40 / 3,7 / 12	1	325189

Please observe: Please see Applications Guide on page 274-278.

# Diamond cutting blades for petrol powered cutters and joint cutters



Asphalt

Diamond cutting blade

## DT 350 AB EXTRA

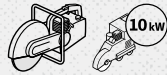

**NEW**

**Properties**

Design	Laser welded
Segmentation	Wide gullet
Aggression	■ ■ ■ ■ □ □ □ □
Service life	■ ■ ■ □ □ □ □ □

**Applications:**

Asphalt	●
Concrete	●



- Inclined protective segment
- Turbo segment
- Block segment

**Advantages:** Multi-purpose product for all repairs on asphalt and concrete thanks to laser-welded block segments, turbo segments and slanted protective segments - Can be used on gasoline-powered cutters and joint cutters with up to 10 kW

Diameter x Bore in mm	Max. operating speed	Max. RPM	Segmentation	Segment in mm Number / Length / Width / Height	Packing unit/pcs.	Cat. number
300 x 20	100 m/s	6400 rpm		18 / 40 / 2,8 / 12	1	340232
300 x 25,4	100 m/s	6400 rpm		18 / 40 / 2,8 / 12	1	340241
350 x 20	100 m/s	5500 rpm		21 / 40 / 3,2 / 12	1	340236
350 x 25,4	100 m/s	5500 rpm		21 / 40 / 3,2 / 12	1	340240
400 x 25,4	100 m/s	4800 rpm		24 / 40 / 3,4 / 12	1	340239

Asphalt

Diamond cutting blade

## DT 612 AB SUPRA

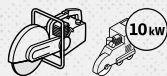

**Properties**

Design	Laser welded
Segmentation	Wide gullet
Aggression	■ ■ ■ ■ ■ ■ □ □
Service life	■ ■ ■ ■ ■ □ □ □

**Applications:**

Asphalt	●
Concrete	●



- Protective segments
- Titanium-coated diamonds

**Advantages:** Suitable for asphalt and concrete - Specially engineered for use on both materials - High cutting speed, excellent service life

Diameter x Bore in mm	Max. operating speed	Max. RPM	Segmentation	Segment in mm Number / Length / Width / Height	Packing unit/pcs.	Cat. number
300 x 20	100 m/s	6400 rpm		18 / 40 / 2,8 / 10	1	332344
300 x 25,4	100 m/s	6400 rpm		18 / 40 / 2,8 / 10	1	330080
350 x 20	100 m/s	5500 rpm		21 / 40 / 3,2 / 10	1	332345
350 x 25,4	100 m/s	5500 rpm		21 / 40 / 3,2 / 10	1	330081
400 x 20	100 m/s	4800 rpm		24 / 40 / 3,4 / 10	1	332346
400 x 25,4	100 m/s	4800 rpm		24 / 40 / 3,4 / 10	1	330082
450 x 25,4	100 m/s	4300 rpm		28 / 40 / 3,7 / 10	1	330083
500 x 25,4	100 m/s	3900 rpm		30 / 40 / 3,7 / 10	1	330084

Please observe: Please see Applications Guide on page 274-278.

Diamond tools



# Diamond cutting blades for joint cutters

Concrete

Diamond cutting blade

## DT 910 BF SPECIAL

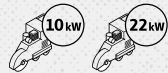

### Properties

Design	Laser welded
Segmentation	with protective segments
Aggression	■■■■■■■□
Service life	■■■■■■■□

### Applications:

Green concrete	●
----------------	---

**Advantages:** Smooth and easy cutting performance - 12 mm tall segments - Protective segments shield the core - Unsurpassed service life thanks to a high concentration of premium-grade diamonds - Exceptionally well suited for fresh concrete

Diameter x Bore in mm	Max. operating speed	Max. RPM	Segmentation	Segment in mm Number / Length / Width / Height	Packing unit/pcs.	Cat. number
300 x 25,4	100 m/s	6400 rpm		21 / 40 / 2,8 / 12	1	330085
350 x 25,4	100 m/s	5500 rpm		24 / 40 / 3,2 / 12	1	330086
400 x 25,4	100 m/s	4800 rpm		28 / 40 / 3,4 / 12	1	330087
450 x 25,4	100 m/s	4300 rpm		30 / 40 / 3,7 / 12	1	330088
500 x 25,4	100 m/s	3900 rpm		35 / 40 / 3,7 / 12	1	330089

Concrete

Diamond cutting blade

## DT 602 B SUPRA



### Properties

Design	Laser welded
Segmentation	Wide gullet
Aggression	■■■■■■■□
Service life	■■■■■■■□

### Applications:

Cured concrete	●
Cured concrete, reinforced	●

**Advantages:** First-rate cutting performance - Fast cutting speed - Particularly well suited for concrete with medium reinforcement - Also suitable for use on electric joint cutters

Diameter x Bore in mm	Max. operating speed	Max. RPM	Segmentation	Segment in mm Number / Length / Width / Height	Packing unit/pcs.	Cat. number
300 x 25,4	100 m/s	6400 rpm		18 / 40 / 2,8 / 9	1	325056
350 x 25,4	100 m/s	5500 rpm		21 / 40 / 3,2 / 9	1	325088
400 x 25,4	100 m/s	4800 rpm		24 / 40 / 3,4 / 9	1	325120
450 x 25,4	100 m/s	4300 rpm		26 / 40 / 3,7 / 9	1	325136
500 x 25,4	100 m/s	3900 rpm		30 / 40 / 3,7 / 9	1	325167

Please observe: Please see Applications Guide on page 274-278.

# Diamond cutting blades for petrol powered cutters and joint cutters



Concrete

Diamond cutting blade

## DT 900 B SPECIAL



### Properties

Design	Laser welded
Segmentation	Turbo
Aggression	■■■■■■■■■
Service life	■■■■■■■■■



### Applications:

Cured concrete, reinforced	●
Concrete, universal	●
Construction materials	●
Chalky sandstone	⓪



- Turbo segments
- Titanium-coated diamonds

**Advantages:** High performance blade with ultra high cutting speed thanks to turbo segments - Specially engineered for effortless cutting through concrete - Further increased service life thanks to titanium-coated diamonds

Diameter x Bore in mm	Max. operating speed	Max. RPM	Segment in mm Number / Length / Width / Height	Packing unit/pcs.	Cat. number
300 x 20	100 m/s	6400 rpm	20 / 40 / 2,8 / 12	1	325078
300 x 25,4	100 m/s	6400 rpm	20 / 40 / 2,8 / 12	1	325079
350 x 20	100 m/s	5500 rpm	22 / 40 / 3 / 12	1	325080
350 x 25,4	100 m/s	5500 rpm	22 / 40 / 3 / 12	1	325081
400 x 20	100 m/s	4800 rpm	26 / 40 / 3,2 / 12	1	325113
400 x 25,4	100 m/s	4800 rpm	26 / 40 / 3,2 / 12	1	325114

Concrete

Diamond cutting blade

## DT 902 B SPECIAL



### Properties

Design	Laser welded
Segmentation	Wide gullet
Aggression	■■■■■■■■■
Service life	■■■■■■■■□



### Applications:

Cured concrete	●
Cured concrete, reinforced	●

**Advantages:** First-rate cutting performance - Ultra fast cutting speed - Also suitable for concrete with strong reinforcement

Diameter x Bore in mm	Max. operating speed	Max. RPM	Segmentation	Segment in mm Number / Length / Width / Height	Packing unit/pcs.	Cat. number
300 x 25,4	100 m/s	6400 rpm		18 / 40 / 2,8 / 11	1	325058
350 x 25,4	100 m/s	5500 rpm		21 / 40 / 3,2 / 11	1	325090
400 x 25,4	100 m/s	4800 rpm		24 / 40 / 3,4 / 11	1	325122
450 x 25,4	100 m/s	4300 rpm		26 / 40 / 3,7 / 11	1	325138
500 x 25,4	100 m/s	3900 rpm		30 / 40 / 3,7 / 11	1	325169

Please observe: Please see Applications Guide on page 274-278.

Diamond tools

# Diamond cutting blades for joint cutters

Concrete

Diamond cutting blade

## DT 910 B SPECIAL



### Properties

Design	Laser welded
Segmentation	Narrow gullet
Aggression	■■■■■■■□
Service life	■■■■■■■■■

### Applications:

Cured concrete	●
Cured concrete, reinforced	●

**Advantages:** First-rate cutting performance - High cutting speed - Exceptional service life - Also suitable for concrete with strong reinforcement

Diameter x Bore in mm	Max. operating speed	Max. RPM	Segmentation	Segment in mm Number / Length / Width / Height	Packing unit/pcs.	Cat. number
300 x 25,4	100 m/s	6400 rpm		21 / 40 / 2,8 / 11	1	325073
350 x 25,4	100 m/s	5500 rpm		24 / 40 / 3,2 / 11	1	325106
400 x 25,4	100 m/s	4800 rpm		28 / 40 / 3,4 / 11	1	325146
450 x 25,4	100 m/s	4300 rpm		32 / 40 / 3,7 / 11	1	325182
500 x 25,4	100 m/s	3900 rpm		36 / 40 / 3,7 / 11	1	325193

Reduction rings

## DZ 100 RR



**Advantages:** Reduction rings with serration for enhanced adhesion

Size in mm	Suitable for	Packing unit/pcs.	Cat. number
2 x 25,4 x 20	DT 300 U (325350)	1	328933
2,5 x 25,4 x 20	DT 602 A + DT 600 U	1	328934
1,2 x 22,23 x 15,88	Bore 22,23 mm	1	337148
1,2 x 22,23 x 20	Bore 22,23 mm	1	337282
2 x 30 x 25,4	Bore 30,00 mm	1	337344

Please observe: Please see Applications Guide on page 274-278.

# Drill bits with R 1/2" connection



Concrete

R 1/2" BSP Male drill bit

## DK 612 B SUPRA



### Properties

Design Laser welded

Segmentation Standard

Aggression

Service life

### Applications:

Concrete, universal

**Advantages:** Drill bits for universal applications - High cutting speed and service life - Can be used on electric drilling machines - For replacement segments, see DE 600 B

Diameter in mm	Thread/Shaft	Effective length in mm	Segment in mm				Packing unit/pcs.	Cat. number
			Number	Length	Width	Height		
52	thread 1/2"	300	5	24	2,5	10	1	325720
56	thread 1/2"	300	5	24	2,5	10	1	325721
61	thread 1/2"	300	5	24	2,5	10	1	325722
71	thread 1/2"	300	7	24	2,5	10	1	325724
81	thread 1/2"	300	8	24	2,5	10	1	325755
91	thread 1/2"	300	9	24	2,5	10	1	325756
101	thread 1/2"	300	9	24	2,5	10	1	325757
111	thread 1/2"	300	10	24	2,5	10	1	325758
121	thread 1/2"	300	10	24	2,5	10	1	325759
130	thread 1/2"	300	10	24	2,5	10	1	325761
140	thread 1/2"	300	11	24	2,5	10	1	325762
150	thread 1/2"	300	12	24	2,5	10	1	325763
160	thread 1/2"	300	12	24	2,5	10	1	325764
170	thread 1/2"	300	12	24	2,5	10	1	325765
180	thread 1/2"	300	13	24	2,5	10	1	325766
200	thread 1/2"	300	15	24	2,5	10	1	325768

Diamond tools

Please observe: Please see Applications Guide on page 279.

# Drill bits with 1 1/4" UNC connection

Concrete

1 1/4" UNC Female drill bit

## DK 654 B SUPRA



### Properties

Design Laser welded

Segmentation Standard

Aggression

Service life



### Applications:

Concrete, universal



• 1.1 mm high roofshaped segments

**Advantages:** Drill bits for universal applications - Very fast cutting - Long service life - Roof-shaped segments - Can be used on electric and hydraulic machines - For replacement segments, see DE 600 B

Diameter in mm	Thread/Shaft	Effective length in mm	Segment in mm Number / Length / Width / Height	Packing unit/pcs.	Cat. number
52	thread 1 1/4"	450	5 / 24 / 3,5 / 11	1	325769
56	thread 1 1/4"	450	5 / 24 / 3,5 / 11	1	325770
61	thread 1 1/4"	450	5 / 24 / 3,5 / 11	1	325771
62	thread 1 1/4"	450	5 / 24 / 3,5 / 11	1	325772
66	thread 1 1/4"	450	5 / 24 / 3,5 / 11	1	325773
72	thread 1 1/4"	450	6 / 24 / 3,5 / 11	1	325774
82	thread 1 1/4"	450	7 / 24 / 3,5 / 11	1	325775
92	thread 1 1/4"	450	8 / 24 / 3,5 / 11	1	325776
102	thread 1 1/4"	450	9 / 24 / 3,5 / 11	1	325777
112	thread 1 1/4"	450	10 / 24 / 3,5 / 11	1	325778
122	thread 1 1/4"	450	10 / 24 / 4 / 11	1	325779
132	thread 1 1/4"	450	10 / 24 / 4 / 11	1	325781
142	thread 1 1/4"	450	11 / 24 / 4 / 11	1	325782
152	thread 1 1/4"	450	12 / 24 / 4 / 11	1	325783
162	thread 1 1/4"	450	13 / 24 / 4 / 11	1	325784
172	thread 1 1/4"	450	13 / 24 / 4 / 11	1	325785
182	thread 1 1/4"	450	14 / 24 / 4 / 11	1	325786
202	thread 1 1/4"	450	15 / 24 / 4,5 / 11	1	325787
225	thread 1 1/4"	450	16 / 24 / 4,5 / 11	1	325788
250	thread 1 1/4"	450	17 / 24 / 4,5 / 11	1	325789
300	thread 1 1/4"	450	22 / 20 / 5 / 11	1	325790

Please observe: Please see Applications Guide on page 279.

# Drill bits with ring segments, R 1/2" connection



Concrete

R 1/2" BSP Male drill bit

## DR 912 B SPECIAL



### Properties

### Applications:

Design Laser welded

Concrete, universal ●

Segmentation Standard

Aggression ■■■■■■■■

Service life ■■■■■■■■

**Advantages:** Fast cutting - Long service life on reinforced concrete - Suitable for drill stand or handheld drilling

Diameter in mm	Thread/Shaft	Effective length in mm	Segment in mm Number / Width / Height	Packing unit/pcs.	Cat. number
8	thread 1/2"	300	1 / 2 / 10	1	325791
10	thread 1/2"	300	1 / 2 / 10	1	325792
12	thread 1/2"	300	1 / 2 / 10	1	325793
14	thread 1/2"	300	1 / 2 / 10	1	325794
15	thread 1/2"	300	1 / 2,5 / 10	1	325795
16	thread 1/2"	300	1 / 2,5 / 10	1	325796
18	thread 1/2"	300	1 / 2,5 / 10	1	325797
20	thread 1/2"	300	1 / 2,5 / 10	1	325798
22	thread 1/2"	300	1 / 2,5 / 10	1	325799
24	thread 1/2"	300	1 / 2,5 / 10	1	325800
25	thread 1/2"	300	1 / 2,5 / 10	1	325801
26	thread 1/2"	300	1 / 2,5 / 10	1	325802
28	thread 1/2"	300	1 / 2,5 / 10	1	325803
30	thread 1/2"	300	1 / 2,5 / 10	1	325804
32	thread 1/2"	300	1 / 2,5 / 10	1	325805
35	thread 1/2"	300	1 / 3 / 10	1	325806
40	thread 1/2"	300	1 / 3 / 10	1	325807
42	thread 1/2"	300	1 / 3,5 / 10	1	325808
52	thread 1/2"	300	1 / 3,5 / 10	1	325811

Please observe: Please see Applications Guide on page 279.



# Drill bit segments for DK 654 and DK 612

## Ring segments for drill bits DR 912 B

Concrete

Individual segment

### DE 600 B SUPRA



#### Properties

Design	Laser welded
Segmentation	Standard
Aggression	■■■■■■■□
Service life	■■■■■■■□



#### Applications:

Concrete, universal ●



• 11 mm high roofshaped segments

**Advantages:** Single, roof-shaped segments for a fast first cut - Replacement segments for DK 612 B and DK 654 drill bits

Segment length in mm	Suitable for	Segment in mm Length / Width / Height / Radius	Packing unit/pcs.	Cat. number
20	Ø >272	20 / 5 / 11 / G	30	325839
24	Ø 56-62	24 / 3,5 / 11 / 30	30	325833
24	Ø 72-87	24 / 3,5 / 11 / 40	30	325834
24	Ø 92-112	24 / 3,5 / 11 / 50	30	325835
24	Ø 107-142	24 / 4 / 11 / 60	30	325836
24	Ø 142-182	24 / 4 / 11 / 80	30	325837
24	Ø 182-272	24 / 4 / 11 / 100	30	325838

Concrete

Ring segment

### DO 900 B SPECIAL



#### Properties

Design	Laser welded
Segmentation	Standard
Aggression	■■■■■■■
Service life	■■■■■■■



#### Applications:

Concrete, universal ●

**Advantages:** Replacement ring segment for DR 912 B drill bit

Diameter in mm	Segment in mm Width / Height	Packing unit/pcs.	Cat. number
8	2 / 10	10	325812
10	2 / 10	10	325813
12	2 / 10	10	325814
14	2 / 10	10	325815
15	2,5 / 10	10	325816
16	2,5 / 10	10	325817
18	2,5 / 10	10	325818
20	2,5 / 10	5	325819
22	2,5 / 10	5	325820
24	2,5 / 10	5	325821

Continuation →

Please observe: Please see Applications Guide on page 279.

# Core cutter and adapter kit



→ Continuation of DO 900 B Special, Ring segment

Diameter in mm	Segment in mm Number / Length / Width / Height	Packing unit/pcs.	Cat. number
25	/ 2,5 / 10	5	325822
26	/ 2,5 / 10	5	325823
28	/ 2,5 / 10	5	325824
30	/ 2,5 / 10	3	325825
32	/ 2,5 / 10	3	325826
35	/ 3 / 10	3	325827
40	/ 3 / 10	3	325828
42	/ 3,5 / 10	3	325829
52	/ 3,5 / 10	3	325832

Universal

Core cutter for switch boxes

## DD 600 U SUPRA



### Properties

Design	Laser welded
Edge	Segmented
Aggression	■ ■ ■ ■ □ □ □ □
Service life	■ ■ ■ ■ ■ ■ □

### Applications:

Masonry	●
Construction materials	●
Chalky sandstone	●

**Advantages:** For machining soft and medium-hard materials such as brick, clinker and firebrick - Hexagon mounting with center drill bit are separately available (see ADS200)

Diameter in mm	Thread/Shaft	Effective length in mm	Segment in mm Number / Length / Width / Height	Packing unit/pcs.	Cat. number
68	thread M16	70	3 / 24 / 3,5 / 7	1	325390
82	thread M16	70	4 / 24 / 3,5 / 7	1	325391

Adapter kit

## ADS 200



**Advantages:** SDS / hexagon adapter with 8 mm centre bit for article DD 600 U

Size in mm	Thread/Shaft	Suitable for	Packing unit/pcs.	Cat. number
115	SDS holding device	DD 600 U	1	236588
115	hexagonal	DD 600 U	1	236442

Please observe: Please see Applications Guide on page 279.

Diamond tools

# Diamond drill for stoneware

Tiles

Diamond drill

## DB 600 F SUPRA



### Properties

Design	Vacuum-brazed
Edge	Closed
Aggression	■■■■■□□
Service life	■■■■■□□

### Applications:

Stoneware	●
Stove tiles	●
Stove tiles, glazed	●

**Advantages:** Dry cutting drill bit for drilling with pinpoint accuracy on hard materials such as fine stoneware, granite floor tiles and stove tiles - Clean edges - Precise holes - No bursting, cracking, or splintering - Integrated cooling wax - No water required - Excellent price-performance ratio

Diameter in mm	Thread/Shaft	Max. RPM	Effective length in mm	Segment in mm Number / Height	Packing unit/pcs.	Cat. number
6	1/4" bit, hexagonal	3000 rpm	32	1 / 10	1	325382
8	1/4" bit, hexagonal	3000 rpm	40	1 / 10	1	325527
10	1/4" bit, hexagonal	3000 rpm	40	1 / 10	1	325383
12	1/4" bit, hexagonal	3000 rpm	40	1 / 10	1	325384
14	1/4" bit, hexagonal	3000 rpm	40	1 / 10	1	325528

Tiles

Diamond drill set

## DB 600 F SUPRA Set



### Properties

Design	Vacuum-brazed
Edge	Closed
Aggression	■■■■■□□
Service life	■■■■■□□

### Applications:

Stoneware	●
Stove tiles	●
Stove tiles, glazed	●

**Properties:** 7 piece diamond drill set in a Klingspor case

**Contents:** 2x Ø 6 mm (325382), 1x Ø 8 mm (325527), 1x Ø 10 mm (325383), 1x Ø 12 mm (325384), 1x Ø 14 mm (325528), 1x hole starting aid (313807)

**Advantages:** Diamond drill bits and stainless steel centring aids in a convenient and sturdy aluminium case

Size in mm	Max. RPM	Packing unit/pcs.	Cat. number
200 x 140 x 55	3000 rpm	1	331021

Please observe: Please see Applications Guide on page 279.

Dry drill bit

## DK 600 F SUPRA



### Properties

Design	Vacuum-brazed
Edge	Closed



### Applications:

Stoneware	●
Tiles	●
Stove tiles	●

**Advantages:** Dry drill bit for all standard angle grinders - Suitable for the hardest of tiles, masonry and stoneware - Freehand centering - Precise and accurate drilling - Clean edges, precise holes - No splitting, cracking or chipping - No water needed

Diameter in mm	Thread/Shaft	Max. RPM	Effective length in mm	Segment in mm Number / Height	Packing unit/pcs.	Cat. number
6	thread M14	13300 rpm	35	1 / 10	1	330670
8	thread M14	13300 rpm	35	1 / 10	1	330671
10	thread M14	13300 rpm	35	1 / 10	1	330672
12	thread M14	13300 rpm	35	1 / 10	1	330673
14	thread M14	13300 rpm	35	1 / 10	1	330674
20	thread M14	13300 rpm	45	1 / 15	1	330675
22	thread M14	13300 rpm	45	1 / 15	1	330676
25	thread M14	13300 rpm	45	1 / 15	1	330677
26	thread M14	13300 rpm	45	1 / 15	1	325385
30	thread M14	13300 rpm	45	1 / 15	1	330678
35	thread M14	13300 rpm	45	1 / 15	1	330679
38	thread M14	13300 rpm	45	1 / 15	1	325386
40	thread M14	13300 rpm	45	1 / 15	1	330680
45	thread M14	13300 rpm	45	1 / 15	1	330681
50	thread M14	13300 rpm	45	1 / 15	1	330682
58	thread M14	13300 rpm	45	1 / 15	1	325387
65	thread M14	13300 rpm	45	1 / 15	1	325388
68	thread M14	13300 rpm	45	1 / 15	1	330683
70	thread M14	13300 rpm	45	1 / 15	1	325389
82	thread M14	13300 rpm	50	1 / 15	1	330685
112	thread M14	13300 rpm	50	1 / 15	1	330684

Please observe: Please see Applications Guide on page 279.

# Dry drill bit for stoneware / Accessory

Tiles

Dry drill bit set

## DK 600 F SUPRA Set



### Properties

Design	Vacuum-brazed
Edge	Closed



### Applications:

Stoneware	●
Tiles	●
Stove tiles	●

**Properties:** 6-piece dry drill bit set in a Klingspor case

**Contents:** 2x Ø 6 mm (330670), 2x Ø 8 mm (330671), 1x Ø 10 mm (330672), 1x Ø 12 mm (330673)

**Advantages:** Dry drill bits in a convenient and sturdy aluminium case

Size in mm	Max. RPM	Packing unit/pcs.	Cat. number
110 x 130 x 100	13300 rpm	1	331076

Hole starting aid

## ABH 80



**Advantages:** Hole starting aid for professional diamond dry drill DB 600 F

Size in mm	Suitable for	Packing unit/pcs.	Cat. number
55	DB 600 F	1	313807

Please observe: Please see Applications Guide on page 279.

# Notes



---

A large grid of small dots for taking notes.





Schlertfix  
Schlertfix  
Schlertfix  
Schlertfix

# Flexible abrasives



## About the product

### R-Flex abrasives

Used for finishing and polishing all kinds of surfaces. Despite their elastic construction, R-Flex abrasives boast a long service life with high dimensional stability throughout their use.

### Mounted points

Available in numerous sizes and grains. They are used for apparatus and container construction, in the aviation and automobile industries, as well as in the food and chemical sectors.

### The Sandflex hand block

Cleans, polishes and matt finishes a large variety of materials including metal, wood, paints, plastics, rubber and paper. In addition to its commercial applications, the Sandflex hand block is also excellent for car care and jobs around the house like cleaning iron soleplates, ski edges etc. Sandflex performs even better when used with water, soap, paraffin oil or pastes. With four different grain sizes to choose from, you will find the right product for all types of materials and jobs.

### R-Flex wheels

Available with silicon carbide or corundum grit in different binding hardnesses and dimensions. Typical applications are deburring plastic parts, giving surgical instruments their final finish, sharpening knives, etc. R-Flex wheels are, due to their elastic attachment, easy to shape and adjust to the contours of the tool during grinding.



Clamping pin of the R-Flex mottling points (with milled plane surface) in the standard version

### Mottling points

Create special surface effects with a uniform, extra fine finish. R-Flex mottling points are used with great success for surface treatment applications in tank and container construction (breweries, wine and champagne producers) and in plant construction for commercial kitchens. They are available with bonding agents E (specially designed for aluminium and NF metals) and the softer, more elastic bonding agents W and T (for stainless steel) – with the T bonding agent creating a glossier finish on stainless steel surfaces and offering suitability for universal use.

From stock, Klingspor mottling points ship with a 6 mm shaft and a milled plane surface, making it possible to fix the tools securely in place inside the machine adapter with a screw. If requested or made necessary by the respective machine, the mottling points can also be supplied as made-to-order items without a flat portion and a full length round shaft.

Description	Type	Material applications											Page	
		Iron	Steel	Stainless steel	NF metals	Wood	Paint / Varnish	Glass / Stone	Plastic	Leather	Paper	Ceramic		Porcelain
R-Flex	<i>RFS 651 bond E</i>			●	●									321
	<i>RFM 652 bond E</i>				●									321
	<i>RFR 654 bond Z/E</i>	●	●	●	●	○	○	○	●			○	○	324
Sandflex	<i>SFM 656 bond W</i>			●										322
	<i>SFM 656 bond T</i>			●										322
	<i>SFK 655 block</i>	●	●	●	●	●	●	●	●	●	●	●	●	323

● = main application ○ = possible application

# Flexible abrasives

## Applications guide

R-Flex points for cleaning and finishing and R-Flex wheels are ideally suited for fine machining surfaces thanks to their elastically embedded grit. Matching any type of possible application, Klingspor offers an extensive range of tools with a large variety of dimensions, grit sizes and three different kinds of bonding agents (hard, medium and soft). The chart below provides an overview of the available versions:



Example of a decorative finish created with an R-Flex mottling point SFM 656 on a stainless steel sheet

### Dimensions R-Flex point RFS 651

Ø [mm]	Possible widths [mm]	Grit size	Minimum order quantities	Requested grit type / grit size
15	15, 20, 25, 30	60, 120, 240	10	from 450 pieces
20	15, 20, 25, 30	60, 120, 240	10	from 450 pieces
25	10, 15, 20, 25, 30	60, 120, 240	10	from 250 pieces
30	10, 15, 20, 25, 30	60, 120, 240	10	from 250 pieces
40	10, 15, 20, 30, 40	60, 120, 240	10	from 160 pieces
50	10, 20, 30, 40	60, 120, 240	10	from 110 pieces
60	30, 40	60, 120, 240	10	from 90 pieces

### Dimensions R-Flex wheel RFR 654

Ø [mm]	Possible widths [mm]	Grit size	Minimum order quantities	Requested grit type / grit size
100	10, 15, 20, 25, 30, 35	60, 120, 240	1	from 15 pieces
125	10, 15, 20, 25, 30, 35	60, 120, 240	1	from 12 pieces
150	10, 15, 20, 25, 30, 35	60, 120, 240	1	from 6 pieces
175	15, 20, 25, 30, 35	60, 120, 240	1	from 6 pieces
200	15, 20, 25, 30, 35	60, 120, 240	1	from 6 pieces

Other grit sizes on request

### Bonding types for RFS 651 mounted points used for cleaning and finishing as well as for R-Flex wheels RFR 654

Types of bonding	Hardness	Maximum operating speed
Z tough, hard wearing	hard	up to 32 m/s
E non clogging, free cutting (ideal for aluminium)	medium	up to 16 m/s
W elastic, hard wearing, matt finish (ideal for stainless steel)	soft	up to 5 m/s

**To ensure safe handling of R-Flex points and R-Flex wheels, observe the general “FEPA safety recommendations for the correct use of grinding tools” and the “FEPA Safety Code for Bonded Abrasives”.**

### Bonding types for mottling point SFM 656

Types of bonding	Hardness	Maximum operating speed
W elastic, hard wearing, matt finish (ideal for stainless steel)	soft	up to 5 m/s
T elastic, more free cutting, for a glossier finish (ideal for stainless steel)	soft	up to 5 m/s

# Flexible abrasives

Mounted points, mottling points



R-Flex mounted points

## RFS 651



### Properties

Bonding agent	Plastic
Grain	SiC

### Applications:

Aluminium	●
Stainless steel	●
NF metals	●

**Advantages:** Versatile mounted points for cleaning and finishing - Soft abrasion due to elastic structure - Can be used until completely worn down

### Available grits:

16	24	30	36	40	50	60	80	100	120	150	180	220	240	280	320	360	400	500	600	800	1000	1200	1500	2000
----	----	----	----	----	----	----	----	-----	-----	-----	-----	-----	-----	-----	-----	-----	-----	-----	-----	-----	------	------	------	------

Diameter x Height x Shaft in mm	Grit	Bonding agent	Max. operating speed	Max. RPM	Packing unit/pcs.	Cat. number
40 x 15 x 6	60	E	16 m/s	7600 rpm	10	14006
40 x 15 x 6	120	E	16 m/s	7600 rpm	10	14007
40 x 15 x 6	240	E	16 m/s	7600 rpm	10	14008
50 x 10 x 6	240	E	16 m/s	6100 rpm	10	14012
60 x 30 x 6	60	E	16 m/s	5000 rpm	10	14030
60 x 30 x 6	120	E	16 m/s	5000 rpm	10	14031
60 x 30 x 6	240	E	16 m/s	5000 rpm	10	14032

R-Flex mottling points

## RFM 652



### Properties

Bonding agent	Plastic
Grain	SiC

### Applications:

Aluminium	●
NF metals	●

**Advantages:** Produces a satin surface scratch pattern - Soft abrasion due to elastic structure - Can be used until completely worn down - Available in two executions: with flattened shaft for simple and secure clamping (standard execution, stock items) and with full length round shaft (made to order items)

### Available grits:

16	24	30	36	40	50	60	80	100	120	150	180	220	240	280	320	360	400	500	600	800	1000	1200	1500	2000
----	----	----	----	----	----	----	----	-----	-----	-----	-----	-----	-----	-----	-----	-----	-----	-----	-----	-----	------	------	------	------

Diameter x Height x Shaft in mm	Grit	Bonding agent	Max. operating speed	Max. RPM	Packing unit/pcs.	Cat. number
30 x 30 x 6	60	E	8 m/s	5000 rpm	10	14033
30 x 30 x 6	120	E	8 m/s	5000 rpm	10	14034
40 x 30 x 6	120	E	8 m/s	3800 rpm	10	14036
50 x 30 x 6	60	E	8 m/s	3000 rpm	10	14037
50 x 30 x 6	120	E	8 m/s	3000 rpm	10	14038

Please observe: Please see Applications Guide on page 318-320.

# Flexible abrasives

## Mottling points

Sandflex mottling points

### SFM 656



#### Properties

Bonding agent Plastic

Grain SiC

#### Applications:

Stainless steel ●

**Advantages:** Produces a glossy finish on stainless steel surfaces - Soft abrasion due to elastic structure - Can be used until completely worn down - Available in two executions: with flattened shaft for simple and secure clamping (standard execution, stock items) and with full length round shaft (made to order items)

#### Available grits:

		16	24	30	36	40	50	60	80	100	120	150	180	220	240	280	320	360	400	500	600	800	1000	1200	1500	2000
Diameter x Height x Shaft in mm	Grit	Bonding agent		Max. operating speed		Max. RPM		Packing unit/pcs.		Cat. number																
30 x 30 x 6	60	T		5 m/s		3200 rpm		10		334988																
30 x 30 x 6	60	W		5 m/s		3200 rpm		10		13856																
30 x 30 x 6	120	T		5 m/s		3200 rpm		10		334990																
30 x 30 x 6	120	W		5 m/s		3200 rpm		10		13857																
40 x 30 x 6	60	T		5 m/s		2400 rpm		10		334991																
40 x 30 x 6	60	W		5 m/s		2400 rpm		10		13859																
40 x 30 x 6	120	T		5 m/s		2400 rpm		10		334992																
40 x 30 x 6	120	W		5 m/s		2400 rpm		10		13860																
50 x 30 x 6	60	T		5 m/s		1900 rpm		10		334993																
50 x 30 x 6	60	W		5 m/s		1900 rpm		10		13862																
50 x 30 x 6	120	T		5 m/s		1900 rpm		10		334994																
50 x 30 x 6	120	W		5 m/s		1900 rpm		10		13863																
60 x 30 x 6	60	T		5 m/s		1600 rpm		10		334995																
60 x 30 x 6	60	W		5 m/s		1600 rpm		10		13865																
60 x 30 x 6	120	T		5 m/s		1600 rpm		10		334996																
60 x 30 x 6	120	W		5 m/s		1600 rpm		10		13866																

Please observe: Please see Applications Guide on page 318-320.



# Flexible abrasives

Hand block



Hand block

## SFK 655



### Properties

Bonding agent	Plastic
Grain	SiC

### Applications:

Paint/Varnish	●	Leather	●
Glass/Stone	●	Metals	●
Wood	●		
Plastic	●		

**Advantages:** Universal hand block for cleaning and finishing - Can be used on many materials - Cleaning performance is significantly increased by use of additives - Soft abrasion due to elastic structure - Can be used until completely worn down

### Available grits:

16	24	30	36	40	50	60	80	100	120	150	180	220	240	280	320	360	400	500	600	800	1000	1200	1500	2000
----	----	----	----	----	----	----	----	-----	-----	-----	-----	-----	-----	-----	-----	-----	-----	-----	-----	-----	------	------	------	------

Width x Length x Height in mm	Grit	Packing unit/pcs.	Cat. number
80 x 50 x 20	30	18	13800
80 x 50 x 20	60	18	13801
80 x 50 x 20	120	18	13802
80 x 50 x 20	240	18	13803
150 x 80 x 20	30	1	13804
150 x 80 x 20	60	1	13805
150 x 80 x 20	120	1	63231
150 x 80 x 20	240	1	13807

Hand block

## SFK 655 Set



### Properties

Bonding agent	Plastic
Grain	SiC

### Applications:

Paint/Varnish	●	Leather	●
Glass/Stone	●	Metals	●
Wood	●		
Plastic	●		

**Advantages:** Universal hand block for cleaning and finishing - Can be used on many materials - Cleaning performance is significantly increased by use of additives - Soft abrasion due to elastic structure - Can be used until completely worn down

**Contents:** 18 pcs. / 6 pieces in grit 60, 120, 240 each

### Available grits:

16	24	30	36	40	50	60	80	100	120	150	180	220	240	280	320	360	400	500	600	800	1000	1200	1500	2000
----	----	----	----	----	----	----	----	-----	-----	-----	-----	-----	-----	-----	-----	-----	-----	-----	-----	-----	------	------	------	------

Width x Length x Height in mm	Packing unit/pcs.	Cat. number
80 x 50 x 20	1	72129

Please observe: Please see Applications Guide on page 318-320.



# Flexible abrasives

R-Flex wheel

R-flex wheel

## RFR 654



### Properties

Bonding agent	Plastic
Grain	Aluminium oxide/SiC

### Applications:

Stainless steel	●	Plastic	●
Steel	●	Glass	⓪
NF metals	●		
Aluminium	●		

**Advantages:** Versatile abrasive wheel - Deburring, matt finishing and finishing with one tool - Good adaptation to workpiece contour - Soft abrasion due to elastic structure - Can be used until completely worn down

### Available grits:

16 24 30 36 40 50 60 80 100 120 150 180 220 240 280 320 360 400 500 600 800 1000 1200 1500 2000

All sizes and minimum purchasing quantities available on request

Please observe: Please see Applications Guide on page 318-320.



---

A large grid of small dots for taking notes.











# Carbide burrs





## About the product

### Powerful milling and leveling of surfaces and forms

Klingspor carbide burrs are used wherever outstanding stock removal and service life are pivotal to the proper processing of hard-to-reach places. The burrs are manufactured according to the highest quality standards and with utmost precision. Our comprehensive product selection offers all shapes and dimensions

necessary to find the solution that matches each application best. Thanks to the abundance of available toothing options, you can be sure to achieve the desired outcome on any material and with unparalleled speed.

Type	Form	Page
HF 100 A (ZYA)	 Cylindrical	330
HF 100 B (ZYAS)	 Cylindrical with end cut	331
HF 100 C (WRC)	 Cylindrical with spherical head	332
HF 100 D (KUD)	 Spherical shape	333
HF 100 E (TRE)	 Oval shape	334
HF 100 F (RBF)	 Conical shape	334
HF 100 G (SPG)	 Arch shape	335
HF 100 H	 Flame shape	336

Type	Form	Page
HF 100 J (KSI)	 Conical shape, pointed nose (60°)	336
HF 100 K (KSK)	 Conical shape, pointed nose (90°)	337
HF 100 L (KEL)	 Conical shape, round nose	337
HF 100 M (SKM)	 Conical shape, pointed nose	338
HF 100 N (WKN)	 Dovetail	338

Sets of burrs		
HF 100	Set, 40 carbide burrs	339
HF 100	Set, 5 carbide burrs	339
HF 100 Steel	Set, 5 carbide burrs	340
HF 100 INOX	Set, 5 carbide burrs	340

Cut	Materials																							
	Steel		Soft NF metals				Hard NF metals				Creep resistant materials		Cast iron		Plastics									
	Carbon steel	Tool steel	Non-alloyed steel	Case-hardened steel	Cast steel	Alloyed steel	Hardened steel	Aluminium	Messing	Copper	Zinc	Bronze	Titanium	Titanium alloy	Aluminium alloy (high SiC contingent)	Nickel based alloy	Cobalt based alloy	Grey cast iron	White cast iron	GRP	CFRP	Ebonite / Hard rubber	Thermoplastic material	Thermosets
2	●	●	●	●	●	●	●		●	●	●	●	●	●	●	●	●	●	●					●
3								●	●	●	●												●	●
6	●	●	●	●	●	●	●		●	●		●	●	●	●	●	●	●	●	●	●			●
10	●	●	●	●	●	●	●											●	●					
11																●	●							

● = main application ○ = possible application

# Carbide burrs

## Applications guide

### The cuts at a glance

#### 2 Cuts

Standard cut / plain cut with good finishing properties for universal applications.

#### 3 Cuts aluminium

High stock removal rate and reduced clogging of teeth for working on long-chipping and soft materials like NF metals and plastics.

#### 6 Cuts mega seller

Double cut for universal applications, improved handling and low vibration. Creates a small chip.



### New high performance tooth geometries for steel and INOX processing

Perfectly adapted to the respective group of processed material, the newly engineered blade geometries 10 (steel) and 11 (INOX) allow for a significantly higher stock removal rate when compared to the cross-cut toothing typically found on ordinary burrs.

#### The advantages at a glance:

- ▶ higher level of aggressiveness and cutting performance
- ▶ improved chip removal
- ▶ markedly enhanced service life thanks to reduced built-up edge formation
- ▶ less thermal stress on tool and workpiece
- ▶ decrease in annealing colours during INOX applications

#### 10 cuts high performance tooth geometry - steel

Toothing optimised for steel processing; significantly higher stock removal rate compared to a standard cross-cut tooth geometry

#### 11 cuts high performance tooth geometry - INOX

Toothing optimised for the processing of austenitic as well as corrosion and acid-resistant grades of stainless steel; strikingly improved stock removal performance by contrast with standard cross-cut tooth geometries



**Additional cuts available on request**

## Important safety recommendations

- ▶ Please ensure that a maximum 30% of the tools circumference is in contact with the workpiece
- ▶ Extra long burrs with extended shank require slower operating speeds
- ▶ Ensure the burr is clamped correctly in a regularly maintained operating tool
- ▶ Run the selected burr at the correct operating speed to avoid risks and to ensure an optimum tool performance
- ▶ Please observe the safety recommendations on the packaging

## Maximum operating speeds

Burr head in mm	Max. RPM
2/2,4/3	100,000
4/4,8/5/6/6,3	65,000
8/9,6/10/11	55,000
12/12,7	35,000
16	25,000
19,2	20,000
25,4	15,000

## Recommended operating speeds

Burr head diameter in mm	Optimal speed range (RPM), depending on materials			
	The values in brackets are recommended starting speeds (start points) if no empirical values are already available			
	NF metals	Aluminium, plastic	Unhardened steels	Hardened steels, stainless steel
2/2,4/3	45,000	60,000	60,000	60,000
	(65,000)	(65,000)	(80,000)	(80,000)
	<b>up to 80,000</b>	<b>up to 80,000</b>	<b>up to 80,000</b>	<b>up to 80,000</b>
4/4,8/5/6/6,3	22,000	15,000	45,000	30,000
	(45,000)	(40,000)	(50,000)	(40,000)
	<b>up to 60,000</b>	<b>up to 60,000</b>	<b>up to 60,000</b>	<b>up to 45,000</b>
8/9,6/10/11	15,000	10,000	30,000	19,000
	(30,000)	(25,000)	(30,000)	(25,000)
	<b>up to 40,000</b>	<b>up to 50,000</b>	<b>up to 40,000</b>	<b>up to 30,000</b>
12/12,7	11,000	7,000	22,000	15,000
	(25,000)	(20,000)	(25,000)	(20,000)
	<b>up to 30,000</b>	<b>up to 30,000</b>	<b>up to 30,000</b>	<b>up to 22,000</b>
16	9,000	6,000	18,000	12,000
	(20,000)	(15,000)	(20,000)	(15,000)
	<b>up to 20,000</b>	<b>up to 20,000</b>	<b>up to 20,000</b>	<b>up to 18,000</b>
19,2	8,000	5,000	15,000	10,000
	(12,000)	(10,000)	(15,000)	(10,000)
	<b>up to 17,000</b>	<b>up to 17,000</b>	<b>up to 17,000</b>	<b>up to 15,000</b>
25,4	6,000	4,000	10,000	7,000
	(10,000)	(8,000)	(10,000)	(8,000)
	<b>up to 13,000</b>	<b>up to 13,000</b>	<b>up to 13,000</b>	<b>up to 11,000</b>



# Carbide Burrs

Carbide burr

## HF 100 A



**Properties:** Cylindrical burr without end-cut - Designation in accordance with DIN 8032: ZYA

**Advantages:** For universal use - Especially suitable for surface grinding



Diameter in mm	Height in mm	Total length in mm	Shaft diameter in mm	Cut	Packing unit/pcs.	Cat. number
3	14	38	3	6	5	295482
6	18	50	6	2	1	295521
9,6	19	64	6	3	1	295563
12,7	25	70	6	3	1	295604
6	18	50	6	6	1	295531
8	19	64	6	6	1	295552
9,6	19	64	6	6	1	295568
12,7	19	64	6	6	1	295594
12,7	25	70	6	6	1	295609
16	25	70	6	6	1	295621
6	18	50	6	10	1	334116
8	19	64	6	10	1	334118
9,6	19	64	6	10	1	334120
12,7	25	70	6	10	1	334122
6	18	50	6	11	1	334117
8	19	64	6	11	1	334119
9,6	19	64	6	11	1	334121
12,7	25	70	6	11	1	334123

Please observe: Please see Applications Guide on page 326-329.

Carbide burr

## HF 100 B



**Properties:** Cylindrical burr with end cut - Designation in accordance with DIN 8032: ZYAS

**Advantages:** The end cut makes it suitable for blind holes and faces on inner contours



Diameter in mm	Height in mm	Total length in mm	Shaft diameter in mm	Cut	Packing unit/pcs.	Cat. number
3	14	38	3	6	5	295483
6,3	12,7	55	3	6	5	295507
6	18	50	6	2	1	295522
12,7	25	70	6	2	1	295603
6	18	50	6	3	1	295526
9,6	19	64	6	3	1	295564
12,7	25	70	6	3	1	295605
6	18	50	6	6	1	295532
8	19	64	6	6	1	295553
9,6	19	64	6	6	1	295569
12,7	19	64	6	6	1	295595
12,7	25	70	6	6	1	295610
16	25	70	6	6	1	295622
6	18	50	6	10	1	334124
8	19	64	6	10	1	334125
9,6	19	64	6	10	1	334131
12,7	25	70	6	10	1	334132

Please observe: Please see Applications Guide on page 326-329.

# Carbide Burrs

Carbide burr

## HF 100 C



**Properties:** Cylindrical burr with ball end - Designation in accordance with DIN 8032: WRC

**Advantages:** For universal use on surfaces, contours and radiuses



Diameter in mm	Height in mm	Total length in mm	Shaft diameter in mm	Cut	Packing unit/pcs.	Cat. number
3	14	38	3	2	5	295649
3	14	38	3	6	5	295654
6,3	12,7	44	3	6	5	295673
6	18	50	6	2	1	295686
12,7	25	70	6	2	1	295747
6	18	50	6	3	1	295688
9,6	19	63	6	3	1	295725
12,7	25	70	6	3	1	295750
6	18	50	6	6	1	295694
8	19	63	6	6	1	295713
9,6	19	63	6	6	1	295727
12,7	19	64	6	6	1	295741
12,7	25	70	6	6	1	295753
16	25	70	6	6	1	295763
6	18	50	6	10	1	334133
8	19	64	6	10	1	334135
9,6	19	64	6	10	1	334137
12,7	25	70	6	10	1	334140
6	18	50	6	11	1	334134
8	19	64	6	11	1	334136
9,6	19	64	6	11	1	334138
12,7	25	70	6	11	1	334139

Please observe: Please see Applications Guide on page 326-329.

Carbide burr

## HF 100 D



**Properties:** Ball-shaped burr - Designation in accordance with DIN 8032: KUD

**Advantages:** For use on contours - For deburring bore holes



Diameter in mm	Height in mm	Total length in mm	Shaft diameter in mm	Cut	Packing unit/pcs.	Cat. number
3	2,5	38	3	2	5	295778
3	2,5	38	3	6	5	295784
4	3,4	38	3	6	5	295798
6	4,7	50	6	2	1	295815
9,6	8	54	6	3	1	300054
12,7	11	56	6	3	1	295857
6	4,7	50	6	6	1	295819
8	6	52	6	6	1	295831
9,6	8	54	6	6	1	295843
12,7	11	56	6	6	1	295859
16	14	60	6	6	1	295868
6	4,7	50	6	10	1	334141
8	6	52	6	10	1	334143
9,6	8	54	6	10	1	334146
12,7	11	56	6	10	1	334147
6	4,7	50	6	11	1	334142
8	6	52	6	11	1	334144
9,6	8	54	6	11	1	334145
12,7	11	56	6	11	1	334148

Please observe: Please see Applications Guide on page 326-329.

# Carbide Burrs

Carbide burr

## HF 100 E



**Properties:** Drop-shaped burr - Designation in accordance with DIN 8032: TRE

**Advantages:** For milling out fillet welds - Suitable for working on moulded parts



Diameter in mm	Height in mm	Total length in mm	Shaft diameter in mm	Cut	Packing unit/pcs.	Cat. number
8	15	60	6	6	1	295909
9,6	16	60	6	6	1	295916
12,7	22	67	6	6	1	295925
12,7	22	67	6	10	1	334149
12,7	22	67	6	11	1	334150

Carbide burr

## HF 100 F



**Properties:** Semi-circular burr - Designation in accordance with DIN 8032: RBF

**Advantages:** Well suited for working on moulded parts



Diameter in mm	Height in mm	Total length in mm	Shaft diameter in mm	Cut	Packing unit/pcs.	Cat. number
3	14	38	3	2	5	295946
3	14	38	3	6	5	295951
9,6	19	64	6	3	1	295985
12,7	25	70	6	3	1	296007
6	18	50	6	6	1	295971
9,6	19	64	6	6	1	295987
8	20	65	6	6	1	295978
12,7	25	70	6	6	1	296010
16	25	70	6	6	1	296020
6	18	50	6	10	1	334151
9,6	19	64	6	10	1	334155
8	20	65	6	10	1	334153

Continuation →

Please observe: Please see Applications Guide on page 326-329.

→ Continuation of HF 100 F, Carbide Burr

Diameter in mm	Height in mm	Total length in mm	Shaft diameter in mm	Cut	Packing unit/pcs.	Cat. number
12,7	25	70	6	10	1	334157
6	18	50	6	11	1	334152
9,6	19	64	6	11	1	334156
8	20	65	6	11	1	334154
12,7	25	70	6	11	1	334158

Carbide burr

## HF 100 G



**Properties:** Pointed arch-shaped burr with flattened tip - Designation in accordance with DIN 8032: SPG

**Advantages:** Ideal for chamfering - For deburring bore holes



Diameter in mm	Height in mm	Total length in mm	Shaft diameter in mm	Cut	Packing unit/pcs.	Cat. number
3	14	38	3	2	5	296043
3	14	38	3	6	5	296047
6,3	12,7	45	3	6	5	296055
6	18	50	6	2	1	296058
6	18	50	6	6	1	296062
8	19	64	6	6	1	296066
9,6	19	64	6	6	1	296074
12,7	19	64	6	6	1	296079
12,7	25	70	6	6	1	296086
6	18	50	6	10	1	334159
8	19	64	6	10	1	334161
9,6	19	64	6	10	1	334164
12,7	25	70	6	10	1	334165
6	18	50	6	11	1	334160
8	19	64	6	11	1	334162
9,6	19	64	6	11	1	334163
12,7	25	70	6	11	1	334166

Please observe: Please see Applications Guide on page 326-329.



# Carbide Burrs

Carbide burr

## HF 100 H



**Properties:** Flame-shaped burr - No designation in accordance with DIN 8032

**Advantages:** Well suited for working on moulded parts

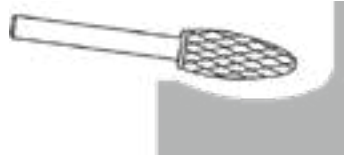

Diameter in mm	Height in mm	Total length in mm	Shaft diameter in mm	Cut	Packing unit/pcs.	Cat. number
3	6	38	3	6	5	296106
8	19	64	6	6	1	296193
9,6	19	65	6	6	1	297074
12,7	32	77	6	6	1	296194
8	19	64	6	10	1	334167
12,7	32	77	6	10	1	334169
8	19	64	6	11	1	334168
12,7	32	77	6	11	1	334170

Carbide burr

## HF 100 J



**Properties:** Conical burr - 60° angle - Designation in accordance with DIN 8032: KSJ;

**Advantages:** Suitable for chamfering or bevelling



All sizes and minimum purchasing quantities available on request

Please observe: Please see Applications Guide on page 326-329.

Carbide burr

## HF 100 K



**Properties:** Conical burr - 90 ° angle - Designation in accordance with DIN 8032: KSK

**Advantages:** For deburring bore holes - For chamfering or bevelling



All sizes and minimum purchasing quantities available on request

Carbide burr

## HF 100 L



**Properties:** Conical round-nosed burr - Designation in accordance with DIN 8032: KEL

**Advantages:** For difficult-to-access areas

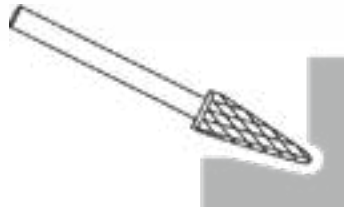

Diameter in mm	Height in mm	Total length in mm	Shaft diameter in mm	Cut	Packing unit/pcs.	Cat. number
3	14	38	3	6	5	296199
9,6	30	76	6	3	1	300055
12,7	32	77	6	3	1	297470
6	18	50	6	6	1	296200
8	25,4	70	6	6	1	296205
9,6	30	76	6	6	1	296201
12,7	32	77	6	6	1	296192
9,6	30	76	6	10	1	334172
12,7	32	77	6	10	1	334173
10	20	65	6	11	1	334204
8	25,4	70	6	11	1	334171
12,7	32	77	6	11	1	334174

Please observe: Please see Applications Guide on page 326-329.

# Carbide Burrs

Carbide burr

## HF 100 M



**Properties:** Pointed cone burr - Designation in accordance with DIN 8032: SKM  
**Advantages:** For deburring tasks - For conical holes and grooves - Ideal for model building



Diameter in mm	Height in mm	Total length in mm	Shaft diameter in mm	Cut	Packing unit/pcs.	Cat. number
3	11	38	3	2	5	296204
3	11	38	3	6	5	296114
6	20	50	6	2	1	296133
6	20	50	6	6	1	296136
9,6	16	64	6	6	1	296144
8	18	64	6	6	1	300052
12,7	22	71	6	6	1	296148

Carbide burr

## HF 100 N



**Properties:** Angular burr without end cut - Designation in accordance with DIN 8032: WKN  
**Advantages:** Suitable for difficult-to-access areas, inner edges or conical profiles



All sizes and minimum purchasing quantities available on request

Please observe: Please see Applications Guide on page 326-329.

Carbide burr

## HF 100 Set



**Properties:** 40 piece burr set, cut 6, in lockable Klingspor presentation box -  
**Contents:** 2 x HF 100 B 6x18x6 (295532), 2 x HF 100 C 6x18x6 (295694), 2 x HF100 F 6x18x6 (295971), 2 x HF100 G 6x18x6 (296062), 2 x HF 100 L 6x18x6 (296200), 2 x HF 100 B 8x19x6 (295553), 2 x HF 100 C 8x19x6 (295713), 2 x HF 100 F 8x20x6 (295978), 2 x HF 100 G 8x19x6 (296066), 2 x HF 100 L 8x25,4x6 (296205), 2 x HF 100 B 9,6x19x6 (295569), 2 x HF 100 C 9,6x19x6 (295727), 2 x HF 100 F 9,6x19x6 (295987), 2 x HF 100 G 9,6x19x6 (296074), 2 x HF 100 L 9,6x30x6 (296201), 2 x HF 100 B 12,7x25x6 (295610), 2 x HF 100 C 12,7x25x6 (295753), 2 x HF 100 F 12,7x25x6 (296010), 2 x HF 100 G 12,7x25x6 (296086), 2 x HF 100 L 12,7x32x6 (296192)

**Advantages:** All top sellers at a glance

Size in mm	Shaft diameter in mm	Cut	Packing unit/pcs.	Cat. number
335 x 225 x 380	6	6	1	300627

Carbide burr

## HF 100 Set



**Properties:** 5 piece burr set, cut 6, in a Klingspor screw box

**Contents:** HF 100 B 9,6x19x6 (295569), HF 100 C 9,6x19x6 (295727), HF 100 D 9,6x8x6 (295843), HF 100 E 9,6x16x6 (295916), HF 100 F 9,6x19x6 (295987)

**Advantages:** Presentation of the top sellers - Practical and safe storage of the burrs

Size in mm	Shaft diameter in mm	Cut	Packing unit/pcs.	Cat. number
70 x 70 x 100	6	6	1	336927

# Carbide Burrs

Carbide burr

## HF 100 Steel



**Properties:** 5 piece burr set, cut 10, in Klingspor screw box

**Contents:** HF 100 A 9.6x19x6 (334120), HF 100 C 9.6x19x6 (334137), HF 100 D 9.6x8x6 (334146), HF 100 F 9.6x19x6 (334155), HF 100 L 9.6x30x6 (334172)

**Advantages:** Presentation of high performance Steel tooth geometry (Cut 10), safe and convenient storage of the burrs - Tothing optimised for processing steel and cast steel - Strikingly improved stock removal performance by contrast with standard cross-cut tooth geometries

Size in mm	Shaft diameter in mm	Cut	Packing unit/pcs.	Cat. number
70 x 70 x 100	6	10	1	337154

Carbide burr

## HF 100 Inox



**Properties:** 5 piece burr set, cut 11, in a Klingspor screw box

**Contents:** HF 100 A 9,6x19,0x6 (334121), HF 100 C 9,6x19x6 (334138), HF 100 D 9,6x8x6 (334145), HF 100 F 9,6x19x6 (334156), HF 100 L 10x20x6 (334204)

**Advantages:** Presentation of the high performance Inox cut - Practical and safe storage of the burrs - Optimized cut for working on austenitic, corrosion and acid-proof stainless steels - Considerably higher stock removal rate compared to the standard double cut

Size in mm	Shaft diameter in mm	Cut	Packing unit/pcs.	Cat. number
70 x 70 x 100	6	11	1	334221

Please observe: Please see Applications Guide on page 326-329.



---

A large grid of small dots for taking notes.







# D.I.Y. range

## The new Klingspor D.I.Y. range in user friendly packaging

The relevant grit ranges and assortments in customised packing units. Uniform packing design, precise product identification for quick access.

Coated abrasives – the ideal presentation: Klingspor offers a display system for an attractive and sales promoting presentation of the products. In clearly arranged shelf modules the important basic articles of the D.I.Y. range of coated abrasives are displayed together with suggestions for the product placement. The shelf modules can be combined individually according to your requirements. The compact space saving display system allows an efficient use of the sales area.

Klingspor expert advisers are at your disposal.

Type	Material applications							Machines							Page		
	Steel	Stainless steel	Paint / varnish / fillers	Wood	Metals	NF metals	Plastics	Glass / stone	Hand grinding	Hand block	Orbital sander	Hand tool belt grinder	Portable belt sander	Angle grinderr		Random orbital sander	Delta sander
PL 31 B			●	●	○				●	●	●						344
CS 310 XF	●	●			●	●						●					344
LS 309 XH			○	●	●	●							●				345
CS 561	●	○		○	●	●	○							●			346
PS 11 A			●			○	●	○	●								347
PS 11 C			●			○	●	○	●								346
PL 31 B			●	●	○						●						347
PL 31 B			●	●	○				●								348
KL 371 X					●	●			●								348
PS 22 K		○	○	●	●		○				●						350
PS 22 K		○	○	●	●		○								●		350
PS 22 K		○	○	●	●		○									●	351
A 60 TZ	●	●				●								●			352

● = main application ○ = possible application



# The D.I.Y. Range

Finishing paper

## PL 31 B D.I.Y. Packs



### Properties

Bonding agent	Glue
Grain	Aluminium oxide
Coating	Semi-open
Backing	B-paper

### Applications:

Paint/Varnish/Filler	●
Wood	●
Metals	○

**Advantages:** Product with optimal price-performance ratio - Optimized wear properties for hand sanding and handheld machine sanding

Available grits:

16	24	30	36	40	50	60	80	100	120	150	180	220	240	280	320	360	400	500	600	800	1000	1200	1500	2000
----	----	----	----	----	----	----	----	-----	-----	-----	-----	-----	-----	-----	-----	-----	-----	-----	-----	-----	------	------	------	------

Width x Length in mm	Grit	Cat. number
115 x 5000	40	241817
115 x 5000	60	241818
115 x 5000	80	241819
115 x 5000	120	241820
115 x 5000	180	241821

Packing unit (Minimum order quantity) = 5 rolls

File belt, abrasive cloth

## CS 310 XF D.I.Y. Packs



### Properties

Bonding agent	Resin
Grain	Aluminium oxide
Coating	Close
Backing	XF-cotton

### Applications:

Stainless steel	●
Metals	●
NF metals	●
Steel	●

**Advantages:** Universal type for working on radiuses and contours with belt files in all areas of metalworking

Available grits:

16	24	30	36	40	50	60	80	100	120	150	180	220	240	280	320	360	400	500	600	800	1000	1200	1500	2000
----	----	----	----	----	----	----	----	-----	-----	-----	-----	-----	-----	-----	-----	-----	-----	-----	-----	-----	------	------	------	------

Width x Length in mm	Grit	Belt joint	Cat. number
13 x 457	40	F4G	248820
13 x 457	60	F4G	248821
13 x 457	120	F4G	248822

Packing unit (Minimum order quantity) = 6 assortments of 3 belts

Other grits and sizes available on request.

Please observe: Please see Applications Guide on page 342-343.

Abrasive cloth

## LS 309 XH D.I.Y. Packs



### Properties

Bonding agent	Resin
Grain	Aluminium oxide
Coating	Close
Backing	X-cotton

### Applications:

Wood	●
Metals	●
NF metals	●
Paint/Varnish/Filler	⊙

**Advantages:** Special type for portable belt sanders - For universal use on wood, metal, paint and varnish - Large product mix of belts for all standard machines

Available grits:

16	24	30	36	40	50	60	80	100	120	150	180	220	240	280	320	360	400	500	600	800	1000	1200	1500	2000
----	----	----	----	----	----	----	----	-----	-----	-----	-----	-----	-----	-----	-----	-----	-----	-----	-----	-----	------	------	------	------

Width x Length in mm	Grit	Belt joint	Cat. number
65 x 410	60	F5	7001
65 x 410	80	F5	7002
65 x 410	120	F5	7004
75 x 457	40	F5	9189
75 x 457	60	F5	9176
75 x 457	80	F5	9172
75 x 457	100	F5	9171
75 x 457	120	F5	7138
75 x 480	60	F5	7007
75 x 480	80	F5	7008
75 x 480	120	F5	7010
75 x 533	40	F5	7018
75 x 533	60	F5	7019
75 x 533	80	F5	7020
75 x 533	100	F5	7021
75 x 533	120	F5	7022
75 x 533	150	F5	7023
75 x 533	180	F5	7077
100 x 560	40	F5	7036
100 x 560	60	F5	7037
100 x 560	80	F5	7038
100 x 560	100	F5	7039
100 x 560	120	F5	7040
100 x 610	40	F5	7080
100 x 610	60	F5	7081
100 x 610	80	F5	7082
100 x 610	100	F5	7083
100 x 610	120	F5	7084
105 x 620	40	F5	7030
105 x 620	60	F5	7031
105 x 620	80	F5	7032
105 x 620	120	F5	7034

Packing unit (Minimum order quantity) = 6 assortments of 3 belts

Other grits and sizes available on request.

Please observe: Please see Applications Guide on page 342-343.

# The D.I.Y. Range

Abrasive fibre disc

## CS 561 D.I.Y. Packs



### Properties

Bonding agent	Resin
Grain	Aluminium oxide
Coating	Close

### Applications:

Steel	●	Stainless steel	ⓘ
NF metals	●	Wood	ⓘ
Metals	●		
Plastic	ⓘ		

**Advantages:** For universal use - Largest selection of diameters, grit sizes and hole patterns

Available grits:

16	24	30	36	40	50	60	80	100	120	150	180	220	240	280	320	360	400	500	600	800	1000	1200	1500	2000
----	----	----	----	----	----	----	----	-----	-----	-----	-----	-----	-----	-----	-----	-----	-----	-----	-----	-----	------	------	------	------

Diameter x Hole in mm	Grit	Hole pattern	Cat. number
115 x 22	24	⊗ 30	255905
115 x 22	40	⊗ 30	255906
115 x 22	60	⊗ 30	255907
115 x 22	80	⊗ 30	255908
115 x 22	120	⊗ 30	255909
125 x 22	24	⊗ 30	255910
125 x 22	40	⊗ 30	255911
125 x 22	60	⊗ 30	255912
125 x 22	80	⊗ 30	255913
125 x 22	120	⊗ 30	255914

Packing unit (Minimum order quantity) = 5 assortments of 5 fibre discs

Abrasive paper, waterproof

## PS 11 C D.I.Y. Packs



### Properties

Bonding agent	Resin
Grain	SiC
Coating	Close
Backing	C-paper

### Applications:

Paint/Varnish/Filler	●
Plastic	●
Glass/Stone	ⓘ
Metals	ⓘ

**Advantages:** Special product for auto repair and painting - For hard and tough surfaces - Good adaptation and high stability - Wet and dry sanding

Available grits:

16	24	30	36	40	50	60	80	100	120	150	180	220	240	280	320	360	400	500	600	800	1000	1200	1500	2000
----	----	----	----	----	----	----	----	-----	-----	-----	-----	-----	-----	-----	-----	-----	-----	-----	-----	-----	------	------	------	------

Width x Length in mm	Grit	Cat. number
230 x 280	120	241787
230 x 280	180	241789

Packing unit (Minimum order quantity) = 5 assortments of 5 sheets

Other grits and sizes available on request.

Please observe: Please see Applications Guide on page 342-343.

Abrasive paper, waterproof

## PS 11 A D.I.Y. Packs



### Properties

Bonding agent	Resin
Grain	SiC
Coating	Close
Backing	A-paper

### Applications:

Paint/Varnish/Filler	●
Plastic	●
Glass/Stone	⓪
Metals	⓪

**Advantages:** Special product for auto repair and painting - For hard and tough surfaces - Good adaptation and high stability - Wet and dry sanding

Available grits:

16	24	30	36	40	50	60	80	100	120	150	180	220	240	280	320	360	400	500	600	800	1000	1200	1500	2000
----	----	----	----	----	----	----	----	-----	-----	-----	-----	-----	-----	-----	-----	-----	-----	-----	-----	-----	------	------	------	------

Width x Length in mm	Grit	Cat. number
230 x 280	240	241790
230 x 280	400	241791

Packing unit (Minimum order quantity) = 5 assortments of 5 sheets

Finishing paper

## PL 31 B D.I.Y. Packs



### Properties

Bonding agent	Glue
Grain	Aluminium oxide
Coating	Semi-open
Backing	B-paper

### Applications:

Paint/Varnish/Filler	●
Wood	●
Metals	⓪

**Advantages:** Product with optimal price-performance ratio - Optimized wear properties for hand grinding - Very fine surface scratch pattern

Available grits:

16	24	30	36	40	50	60	80	100	120	150	180	220	240	280	320	360	400	500	600	800	1000	1200	1500	2000
----	----	----	----	----	----	----	----	-----	-----	-----	-----	-----	-----	-----	-----	-----	-----	-----	-----	-----	------	------	------	------

Width x Length in mm	Grit	Cat. number
230 x 280	40	241776
230 x 280	60	241777
230 x 280	80	241778
230 x 280	120	241779
230 x 280	240	241780

Packing unit (Minimum order quantity) = 5 assortments of 5 sheets

Other grits and sizes available on request.

Please observe: Please see Applications Guide on page 342-343.



# The D.I.Y. Range

Abrasive cloth, blue

## KL 371 X D.I.Y. Packs



### Properties

Bonding agent	Glue
Grain	Aluminium oxide
Coating	Close
Backing	X-cotton

### Applications:

Metals	●
NF metals	●

**Advantages:** Attractively priced universal product for surface hand grinding

Available grits:

16	24	30	36	40	50	60	80	100	120	150	180	220	240	280	320	360	400	500	600	800	1000	1200	1500	2000
----	----	----	----	----	----	----	----	-----	-----	-----	-----	-----	-----	-----	-----	-----	-----	-----	-----	-----	------	------	------	------

Width x Length in mm	Grit	Cat. number
230 x 280	40	241781
230 x 280	60	241783
230 x 280	80	241784
230 x 280	120	241785
230 x 280	240	241786

Packing unit (Minimum order quantity) = 5 assortments of 5 sheets

Finishing paper

## PL 31 B D.I.Y. Packs



### Properties

Bonding agent	Glue
Grain	Aluminium oxide
Coating	Semi-open
Backing	B-paper

### Applications:

Paint/Varnish/Filler	●
Wood	●
Metals	○

**Advantages:** Product with optimal price-performance ratio - Optimised wear properties for hand-held machine grinding - Very fine surface scratch pattern

Available grits:

16	24	30	36	40	50	60	80	100	120	150	180	220	240	280	320	360	400	500	600	800	1000	1200	1500	2000
----	----	----	----	----	----	----	----	-----	-----	-----	-----	-----	-----	-----	-----	-----	-----	-----	-----	-----	------	------	------	------

Width x Length in mm	Grit	Hole pattern	Cat. number
93 x 230	40		241732
93 x 230	60		241733
93 x 230	80		241734
93 x 230	120		241735
93 x 230	180		241736
93 x 230	40	GL 9	241725
93 x 230	60	GL 9	241726
93 x 230	80	GL 9	241727

Other grits and sizes available on request.

Please observe: Please see Applications Guide on page 342-343.

Continuation →

→ Continuation of PL 31 B D.I.Y. Packs, Finishing paper

Width x Length in mm	Grit	Hole pattern	Cat. number
93 x 230	120	GL 9	241728
93 x 230	180	GL 9	241729
93 x 230	240	GL 9	241730
115 x 280	40		241678
115 x 280	60		241679
115 x 280	80		241680
115 x 280	120		241681
115 x 280	180		241682
115 x 280	40	GL 1	241670
115 x 280	60	GL 1	241671
115 x 280	80	GL 1	241673
115 x 280	120	GL 1	241674

Packing unit (Minimum order quantity) = 5 assortments of 10 strips

Finishing paper

## PL 31 B D.I.Y. Packs Set



### Properties

Bonding agent	Glue
Grain	Aluminium oxide
Coating	Semi-open
Backing	B-paper

### Applications:

Paint/Varnish/Filler	●
Wood	●
Metals	⦿

**Advantages:** Product with optimal price-performance ratio - Optimised wear properties for hand-held machine grinding - Very fine surface scratch pattern - Assortments in three pieces grit 40, three pieces grit 80 and four pieces grit 120

Available grits:

16	24	30	36	40	50	60	80	100	120	150	180	220	240	280	320	360	400	500	600	800	1000	1200	1500	2000
----	----	----	----	----	----	----	----	-----	-----	-----	-----	-----	-----	-----	-----	-----	-----	-----	-----	-----	------	------	------	------

Width x Length in mm	Grit	Hole pattern	Cat. number
93 x 230	several grain sizes		241738
93 x 230	several grain sizes	GL 9	241731
115 x 280	several grain sizes		241684

Packing unit (Minimum order quantity) = 5 assortments of 10 strips

Other grits and sizes available on request.

Please observe: Please see Applications Guide on page 342-343.

# The D.I.Y. Range

Abrasive paper, self-fastening

## PS 22 K D.I.Y. Packs



### Properties

Bonding agent	Resin
Grain	Aluminium oxide
Coating	Semi-open
Backing	E-paper

### Applications:

Wood	●	Plastic	⓪
Metals	●		
Stainless steel	⓪		
Paint/Varnish/Filler	⓪		

**Advantages:** High removal rate - Uniform scratch pattern

Available grits:

16	24	30	36	40	50	60	80	100	120	150	180	220	240	280	320	360	400	500	600	800	1000	1200	1500	2000
----	----	----	----	----	----	----	----	-----	-----	-----	-----	-----	-----	-----	-----	-----	-----	-----	-----	-----	------	------	------	------

Width x Length in mm	Grit	Hole pattern	Cat. number
115 x 230	40	GL 15	241663
115 x 230	60	GL 15	241664
115 x 230	80	GL 15	241665
115 x 230	120	GL 15	241666
115 x 230	180	GL 15	241667

Packing unit (Minimum order quantity) = 5 assortments of 10 strips

Abrasive paper, self-fastening

## PS 22 K D.I.Y. Packs



### Properties

Bonding agent	Resin
Grain	Aluminium oxide
Coating	Semi-open
Backing	E-paper

### Applications:

Wood	●	Plastic	⓪
Metals	●		
Stainless steel	⓪		
Paint/Varnish/Filler	⓪		

**Advantages:** Universal abrasive disc for metalworking and woodworking - Uniform surface scratch pattern - Available in many grit sizes and dimensions

Available grits:

16	24	30	36	40	50	60	80	100	120	150	180	220	240	280	320	360	400	500	600	800	1000	1200	1500	2000
----	----	----	----	----	----	----	----	-----	-----	-----	-----	-----	-----	-----	-----	-----	-----	-----	-----	-----	------	------	------	------

Diameter in mm	Grit	Hole pattern	Cat. number
96	40	GLS 15	241656
96	60	GLS 15	241657
96	80	GLS 15	241658
96	120	GLS 15	241659
96	180	GLS 15	241660

Packing unit (Minimum order quantity) = 5 assortments of 5 triangles

Other grits and sizes available on request.

Please observe: Please see Applications Guide on page 342-343.

Abrasive paper, self-fastening

## PS 22 K D.I.Y. Packs



### Properties

Bonding agent	Resin
Grain	Aluminium oxide
Coating	Semi-open
Backing	E-paper

### Applications:

Wood	●	Plastic	○
Metals	●		
Stainless steel	○		
Paint/Varnish/Filler	○		

**Advantages:** Universal abrasive disc for metalworking and woodworking - Uniform surface scratch pattern - Available in many grit sizes and dimensions

### Available grits:

16 24 30 36 40 50 60 80 100 120 150 180 220 240 280 320 360 400 500 600 800 1000 1200 1500 2000

Diameter in mm	Grit	Hole pattern	Cat. number
115	40	○ 0	278805
115	60	○ 0	278806
115	80	○ 0	278807
115	120	○ 0	278808
115	180	○ 0	278809
115	40	⊗ GLS 4	243219
115	60	⊗ GLS 4	241608
115	80	⊗ GLS 4	243220
115	120	⊗ GLS 4	241610
115	180	⊗ GLS 4	241611
125	40	○ 0	278810
125	60	○ 0	278811
125	80	○ 0	278812
125	120	○ 0	278813
125	180	○ 0	278814
125	40	⊗ GLS 5	241614
125	60	⊗ GLS 5	241625
125	80	⊗ GLS 5	241626
125	120	⊗ GLS 5	241627
125	180	⊗ GLS 5	241628
150	40	⊗ GLS 3	241649
150	60	⊗ GLS 3	241650
150	80	⊗ GLS 3	241651
150	120	⊗ GLS 3	241652
150	180	⊗ GLS 3	241653
150	40	⊗ GLS 51	319068
150	60	⊗ GLS 51	319069
150	80	⊗ GLS 51	319070
150	120	⊗ GLS 51	319071
150	180	⊗ GLS 51	319073

Packing unit (Minimum order quantity) = 5 assortments of 5 discs

Other grits and sizes available on request.

Please observe: Please see Applications Guide on page 342-343.

# The D.I.Y. Range

Abrasive paper, self-fastening

## PS 22 K D.I.Y. Packs Set

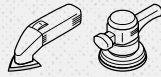

### Properties

Bonding agent	Resin
Grain	Aluminium oxide
Coating	Semi-open
Backing	E-paper

### Applications:

Wood	●	Plastic	⓪
Metals	●		
Stainless steel	⓪		
Paint/Varnish/Filler	⓪		

**Advantages:** Universal abrasive disc for metalworking and woodworking - Uniform surface scratch pattern - Available in many grit sizes and dimensions -

**Set discs:** Assortments in two pieces grit 40, two pieces grit 80 and two pieces grit 120

### Available grits:

16	24	30	36	40	50	60	80	100	120	150	180	220	240	280	320	360	400	500	600	800	1000	1200	1500	2000
----	----	----	----	----	----	----	----	-----	-----	-----	-----	-----	-----	-----	-----	-----	-----	-----	-----	-----	------	------	------	------

Width x Length in mm	Grit	Hole pattern	Cat. number
96	several grain sizes	△ GLS 15	241662
125	several grain sizes	⊙ GLS 5	241630
150	several grain sizes	⊙ GLS 51	319072

Packing unit (Minimum order quantity) = 5 assortments = 30 pieces (discs, triangles)

Cutting-off wheel

## A 60 TZ SPECIAL D.I.Y Packs



### Class

SPECIAL

### Applications:

Bond	■ ■ ■ ■ ■ □ □	Stainless steel	●
Aggression	■ ■ ■ ■ ■ □ □	Steel	●
Service life	■ ■ ■ ■ ■ □ □	NF metals	⓪

**Advantages:** Free of iron, sulfur and chlorine - Short cutting times - Minimal burr formation - Low thermal load

Diameter x Width x Bore in mm	Form	Max. operating speed	Max. RPM	Cat. number
115 x 1 x 22,23	—	80 m/s	13300 rpm	257875
125 x 1 x 22,23	—	80 m/s	12200 rpm	257876

Packing unit (Minimum order quantity) = 1 assortment of 10 cutting-off wheels

Other grits and sizes available on request.

Please observe: Please see Applications Guide on page 342-343.



---

A large grid of small dots for taking notes, consisting of approximately 30 columns and 40 rows of dots.



## Point of Sale

# Point of Sale

### **Flexible, easy care and maintenance, representative: The new, modular POS system by Klingspor**

The full range of products – from the showroom to one-on-one selling. It must be representative, boost sales and be easy to care for – the requirements for a POS are manifold and keep changing. The new POS system by Klingspor can be configured flexibly according to individual needs.

#### **Flexibility**

The new Klingspor POS system is flexibly scalable. Standardised modules with a width of one metre can be flexibly extended in height and width. All new POS elements are fully compatible with previous Klingspor POS modules.

#### **Optimally representative**

The effective image modules complement your POS presentation. The artwork can be customised according to your product range and display requirements.

#### **Minimal effort for care and maintenance**

The modular design and easily changeable magnetic foils keep your display up to date. Popular products and promotions that make for sales momentum can be installed on the display with a few simple steps. Products can be stored in the optional base drawer.

#### **Point of Sale Brochure**

Please request our Point of Sale brochure for more detailed information on the POS elements, modules and accessories.

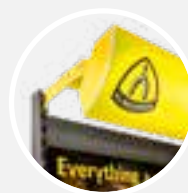

#### **Backlit top panels**

Simple but effective. With backlit top panels that disperse light to the front as well as on the products, you'll find it easy to attract attention to your POS.

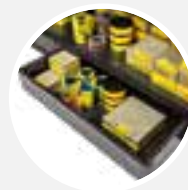

#### **Optional storage space**

A handy base drawer for storing fast moving products.



**Flexible labelling due to detachable magnetic foils**

Provide quick and easy changing.

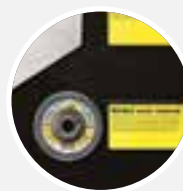

**Representative image module**

Highlight the products in your range with this effective hexagon design, which can be customised accordingly.

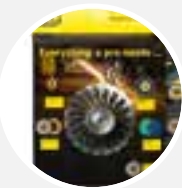

**Customised artwork available**

Design the POS with individual eye-catching designs. We are happy to advise you.



**Magnetic top panels**

The magnetic foils can also be applied to the centre gondola and enable easy care and maintenance.

# Safety recommendations

## Applications guide

### General Principles of Safety

Abrasive products improperly used can be very dangerous.

- ▶ Always follow the instructions provided by the abrasive product and machine supplier.
- ▶ Ensure that the abrasive product is suitable for its intended use. Examine all abrasive products for damage or defects before use.
- ▶ Follow the correct procedures for handling and storage of abrasive products. Be aware of the hazards likely during the use of abrasive products and observe the recommended precautions to be taken:
- ▶ Bodily contact with the abrasive product at operating speed.
- ▶ Injury resulting from product breakage during use.
- ▶ Grinding debris, sparks, fumes and dust generated by the grinding process.
- ▶ Noise
- ▶ Vibration

Use only abrasive products conforming to the highest standards of safety. These products will bear the relevant EN standard number and/or the inscription "oSa":

- ▶ EN 12413 for Bonded Abrasives.
- ▶ EN 13236 for Superabrasives.
- ▶ EN 13743 for Specific Coated Abrasives (vulcanised fibre discs, flap wheels, flap discs and spindle-mounted flap wheels).

Never use a machine that is not in good working order or one with defective parts. Employers should carry out a risk assessment on all individual abrasive processes to determine the appropriate protective measures necessary. They should ensure that their employees are suitably trained to carry out their duties.

More detailed information on the safe use of abrasive products, comprehensive Safety Codes are available from FEPA or your National Trade Association.

- ▶ FEPA Safety Code for Bonded Abrasives and Precision Superabrasives.
- ▶ FEPA Safety Code for Superabrasives for Stone and Construction.
- ▶ FEPA Safety Code for Coated Abrasives.

products 3 years, Rubber products 5 years, Vitrified products 10 years.

- ▶ Check abrasive product or package for any warnings or other safety information.
- ▶ Ensure that the correct abrasive product is selected. Never use a product if it cannot be properly identified.
- ▶ Follow the instructions provided by the abrasive product or machine supplier when mounting abrasive products. Observe any mounting indications marked on the product such as direction of run or mounting position.
- ▶ Never force the abrasive product onto the mounting fixture or modify it to fit.
- ▶ Never exceed the maximum operating speed where specified.
- ▶ Check that the correct mounting devices are used and that they are undistorted, clean and free from burrs.
- ▶ Use mounting blotters where supplied.
- ▶ Do not tighten the mounting device excessively.
- ▶ After mounting or re-mounting an abrasive product, conduct a trial run at operating speed with the guard in place for at least 30 seconds, standing clear of the machine before use.
- ▶ Never remove guards from machines where fitted and ensure they are in good condition and properly adjusted.
- ▶ Ensure that the workpiece is secure and properly supported. Ensure that work rests are properly adjusted and secure.
- ▶ Never start the machine with the workpiece in contact with the abrasive product.
- ▶ Never apply excessive force or shock to the abrasive product or let it overheat.
- ▶ Do not grind on the part of the product that is not designed for the operation.
- ▶ Avoid grinding with the edge of abrasive belts, use the centre of the belt if possible.
- ▶ Avoid clogging and uneven wear to ensure that the abrasive product is working efficiently. Dress frequently where appropriate.
- ▶ Let the abrasive product stop naturally, not by applying pressure to its surface.
- ▶ Turn off and spin out excess coolant before stopping the machine.
- ▶ Do not leave abrasive belts under tension when not in use.

### Precautions against likely hazards

#### Bodily contact with the abrasive product

- ▶ Always take great care and attention when using abrasive products. Tie back long hair and do not wear loose clothing, ties or jewellery.
- ▶ Prevent accidental start up of the machine before mounting or changing an abrasive product. Isolate machines from their power source where necessary.
- ▶ Never remove guards from machines where fitted and ensure they are in good condition and properly adjusted before starting the machine.
- ▶ Always use gloves and suitable clothing where the workpiece or machine is handheld. For gloves, a minimum protection level of EN 388 Category 2 is recommended.
- ▶ After switching off the machine, ensure the product has come to rest before leaving the machine unattended.

#### Injury caused by product breakage

- ▶ Always handle abrasives with great care, they are easily damaged. Examine all products for defects or damage before use.
- ▶ Store abrasives in dry, frost-free conditions avoiding wide variations in temperature. Ensure they are properly protected and supported to prevent damage and distortion.
- ▶ Coated abrasives should be stored at 18-22° C, 45-65% relative humidity.
- ▶ Abrasive belts should be hung on a rod or peg not less than 50mm diameter.
- ▶ Never use an abrasive product beyond its expiry date where marked. Observe the recommended shelf life for the following specific products; Resinoid and Shellac



Not permitted for handheld or manually-guided grinding



Do not use for wet grinding



Not permitted for face grinding



Do not use if damaged



Only permitted with a backing pad



Use ear muffs



Observe safety instructions



Wear safety gloves to protect hands



Wear safety goggles or glasses to protect the eyes



Wear a dust mask



Only permitted for wet cutting



Only permitted for use on totally enclosed machines



# Safety recommendations

## Applications guide



### Grinding debris – sparks, dust and fumes

- ▶ Exposure to dust generated from workpiece and/or abrasive materials can result in lung damage and/or other physical injury.
- ▶ All dry grinding processes should be provided with adequate extraction facilities.
- ▶ Do not use abrasive products near flammable materials.
- ▶ The use of respirators complying with EN149 is recommended for dry grinding processes even if extraction systems are provided.
- ▶ Guards where provided should be adjusted to deflect sparks and debris away from the operator.
- ▶ Take additional measures to protect people working nearby.
- ▶ Eye protection is recommended for all machine applications for abrasives. For handheld machines or workpiece, goggles or full face shields are recommended.
- ▶ Eye protection with a minimum protection of EN166 Grade B is recommended.
- ▶ Ensure that the correct abrasive product is selected. An unsuitable product can produce excessive debris and dust.

### Noise

- ▶ Ear protection complying with EN352 is recommended for all applications where the workpiece or machine is handheld, irrespective of the noise level.
- ▶ Ensure that the correct abrasive product is selected. An unsuitable product can produce excessive noise.

### Vibration

- ▶ Processes where the workpiece or machine is handheld can cause vibration injury.
- ▶ Action needs to be taken if tingling, pins and needles or numbness is experienced after 10 minutes continuous use of the abrasive product.
- ▶ The effects of vibration are more pronounced in cold conditions so keep the hands warm and exercise hands and fingers regularly. Use modern equipment with low vibration levels.
- ▶ Maintain all equipment in good condition and stop the machine and have it checked if excessive vibration occurs.
- ▶ Use good quality abrasive products and keep them in good condition during their life.
- ▶ Maintain mounting flanges and backing pads in good condition and replace if worn or distorted.
- ▶ Do not grip the workpiece or machine too tightly and do not exert excessive pressure on the abrasive product.
- ▶ Avoid continuous use of the abrasive product.
- ▶ Use the correct product. An unsuitable product can produce excessive vibration.
- ▶ Don't ignore the physical symptoms of vibration – seek medical advice.

### Disposal of abrasives

- ▶ Used or defective abrasives should be disposed in accordance with local or national regulations.
- ▶ Further information can be obtained from material safety data sheets provided by the supplier.
- ▶ Be aware that the abrasive product may be contaminated with material from the workpiece or process after use.
- ▶ Disposed abrasive products should be damaged to prevent them from being taken from waste skips and re-used.

## SAFETY RECOMMENDATIONS FOR THE USE OF ABRASIVE BELTS

### 1. General safety recommendations

- ▶ Ensure that quality and dimensions of the belt are correct for the machine and type of application. Refer to the machine manufacturer's instructions.
- ▶ Do not use near easily flammable material.
- ▶ Prevent long hair, loose clothes or jewellery from getting into contact with the machine and being pulled in. Take precautionary measures.
- ▶ Ensure that people nearby are protected from chips, sparks, debris, fumes, dust and noise. Belt grinding operations may produce high concentrations of dust, gas or mist, which can represent a health hazard as well as a risk of explosion.
- ▶ Do not open the guard or put down the machine until the belt has come to a complete standstill.

### 2. Specific safety recommendations

- ▶ Abrasive belts can tear. Please take precautions against risks by tearing of belt (e.g. protective clothing and devices, safety equipment of machinery).
- ▶ Abrasive machines, which do not have a completely closed guard require comprehensive protective equipment of the user (e.g. protective gloves, leather aprons, face shield, dust mask).
- ▶ Check the locking mechanism of the machine cover. Do not remove guards. Any contact with running belts can result in serious injuries.
- ▶ When mounting, refer to direction of running advice, if necessary.
- ▶ Make sure the workpiece is held correctly or is mechanically secured.
- ▶ Start the machine and wait until belt has reached its full operational speed before grinding.
- ▶ Belts should only be used dry unless specified as suitable for wet grinding (please contact the manufacturer if in any doubt).
- ▶ Use the centre of the belt, if possible, and grind as flat as possible. Avoid grinding with the edge of the belt as well as strong punctual loading e.g. through sharp or sharp-edged workpieces.
- ▶ Do not exert excessive pressure and prevent the belt from overheating.
- ▶ Check the belts in use periodically for wear and tear or damage (e.g. cracks at edges, fracturing or strong wear and tear in the joint) and replace the belts if necessary.

Due to the extraordinary variety of applications and machine constructions, these recommendations are limited to basic aspects of safety. Further safety regulations and instructions can be taken from the respective legislation, decrees and technical standards.

# Notes





---

A large grid of small dots for taking notes, consisting of approximately 30 columns and 80 rows of dots.



# Notes





---

A large grid of small dots for taking notes.

# Safety

## Klingspor products are marked with the oSa label



### What does oSa mean?

In a host of applications grinding and cutting require very high peripheral speeds from the rotating abrasive product. These products must therefore be particularly safe so as to stand up to the extreme mechanical and thermal stress.

Regrettably there are no globally binding safety requirements for abrasive products.

This is why responsible manufacturers of abrasive products from a number of European countries set up the Organization for the Safety of Abrasives (oSa) in 2000 and thus setting a clear signal against inferior and dangerous products.

The user recognises these quality grade products from the oSa trade name. They signify to the manufacturer and trader a reduced liability risk, a market and competitive benefit and an image gain.

As a part of their in-house quality management system, the manufacturers see to it that the exact provisions are kept to and that only safe, high quality abrasive products are produced and marketed. The fact that the oSa – Organization for the Safety of Abrasives issues the worldwide protected oSa trademark to members is confirmation of this internal commitment. The oSa label does not mean that the Organization for the Safety of Abrasives or its institutions assume any liability of the designated products.





**Klingspor N.V. / S.A.**  
Herent, België / Belgique

**Клингспор България ЕООД**  
София, България

**KLINGSPOR Brusivo, spol.sr.o.**  
Brno, Česká republika

**Klingspor A/S**  
Kolding, Danmark

**Klingspor Schleifsysteme GmbH & Co. KG**  
Haiger, Deutschland

**Klingspor Abrasivos S.A.**  
Alcobendas (Madrid), España

**Klingspor S.A.S.**  
Le Perray en Yvelines, France

**Klingspor Abrasives Limited**  
Worksop, Nottinghamshire  
Great Britain

**Klingspor S.R.L**  
Brescia, Italia

**Klingspor Magyarország Kft.**  
Budapest, Magyarország

**Klingspor B.V.**  
Sittard, Nederland

**Klingspor Schleifwerkzeuge Gesmbh**  
Wien, Österreich

**Klingspor Sp. z o.o.**  
Bielsko, Polska

**Klingspor Sp. z o.o.**  
Kozy, Polska

**Klingspor România SRL**  
Pantelimon, Ilfov, România

**Клингспор ООО**  
Москва, Россия

**Klingspor d.o.o. Beograd**  
Beograd, Republika Srbija

**Klingspor Suisse GmbH**  
Bubendorf, Suisse

**Клингспор ТОВ**  
Великі Мости, Львівська обл.,  
Україна

**Klingspor Inc.**  
Stoney Creek, Ontario, Canada

**Klingspor Abrasivos S.A. de C.V.**  
Tijuana, Mexico

**Klingspor Abrasives, Inc.**  
Hickory, North Carolina, USA

**Klingspor Qingdao Ltd.**  
Qingdao, P.R. China

**Klingspor Abrasive (Shanghai) Co. Ltd.**  
Shanghai, P.R. China

**Klingspor India Private Limited**  
Pune, India

**Klingspor PTE LTD**  
Singapore, Singapore

**Klingspor PTE LTD**  
Bangkok, Ratcha-anachak Thai

**Klingspor Middle East FZCO**  
Dubai, United Arab Emirates

**Klingspor Vietnam Limited**  
Ho Chi Minh City, Vietnam

**Klingspor Argentina SRL**  
Partido Belén de Escobar,  
Argentina

**Klingspor Abrasivos Industriais Ltd**  
Pinhais, Brasil

**Comercial Klingspor Chile Ltda.**  
Pudahuel, Santiago, Chile

**Klingspor SAC**  
Lima, Perú

**Klingspor Abrasives South Africa (Pty) Ltd.**  
Spartan-Kempton Park,  
South Africa

**Klingspor Australia Pty Ltd**  
Silverwater, Australia

